



Factory Five Racing, Inc.

Part Number: 33871	Revision: D	Effective Date: 6/4/12	By: J. INGERSLEV
Document Type (indicate):	<input type="radio"/> Bill of Material <input checked="" type="radio"/> Assembly Instructions	<input type="radio"/> Drawing (may be attached) <input type="radio"/> Operating Procedure	<input type="radio"/> Specification <input type="radio"/> Other

Hot Rod Coyote Engine

Installation Instructions



Parts needed2

 Ford Racing Parts2

 Ford Motor Co. Parts3

 Summit Racing3

 Fuel System3

 Air Intake System3

 Other vendors3

 Autozone3

Supplies.....3

Information4

Engine prep.....4

 Oil filter relocater4

 Oil Pressure sender9

 Water Temp Sender13

 Engine Bolts17

 Alternator Boss18

Transmission Prep19

Engine/Transmission Installation	21
Fuel System	23
Cooling system	27
Vacuum ports and PCV vent.....	34
Tough emissions	35
Relaxed Emissions.....	38
Steering shaft	42
Wiring.....	44
Black circuit board box	45
Fuel Pump	50
Neutral Safety switch.....	52
Computer mounting.....	54
Starter Solenoid	59
Radiator Cooling Fan.....	64
Power/start.....	67
Gauges.....	70
Tach	70
Water Temp Sender	71
Oil Temp sender	73
O ₂ Harness.....	76
Intercooler wire	77
Power Distribution.....	78
OBD 2 Port.....	78
Alternator.....	79
Wiring.....	84
Accelerator Pedal.....	89
Air Intake.....	108
Mass Air Meter.....	108
Intake tube.....	113
Exhaust	117
Starting the engine	119

Parts needed

Ford Racing Parts

- M-6007-M50 - 5.0L Engine
- M-6017-A504V – 5.0L engine control pack
- M-7003-R58C - TKO transmission
- M-7771-A – Bellhousing bolt kit
- M-9680-M50 – 5.0L engine cover kit
- M-7007-A – Transmission Sandwich plate
- M-6392-M46 - Bellhousing
- M-7560-T46 – Clutch kit
- M-7515-A – Clutch fork
- M-6375-G46A – Flywheel (If not already on engine)
- M-7548-A – Clutch Release Bearing or Ford motor F7ZZ.7548.AA
- M-6397-A46 – Clutch bolt kit
- M-7600-B – Pilot bearing (If not already on engine)
- M-4209ADPT-A - Speed Dial (speedo signal changer)

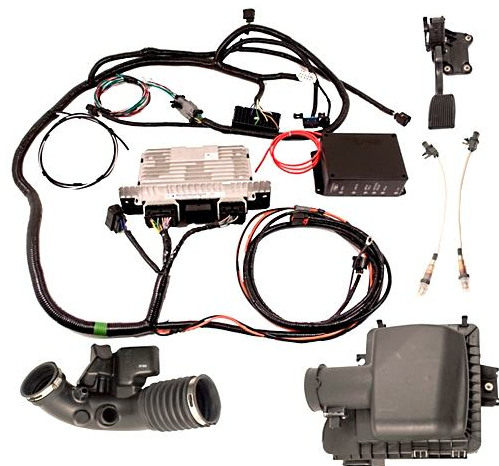

Ford Motor Co. Parts

F3LY-6C070-A – Flywheel access hole plug
BR3Z-8260-B – Mustang upper radiator hose
W500310.S438- Starter bolts (3 needed)
BR3Z-6379-A – Flywheel bolt (8 needed) - If not already on engine

Summit Racing

Fuel System

AEI-13301 – 6AN Fuel pressure regulator
SUM-220166B – 6AN O-ring to straight 6AN Adapter (2 needed)
SUM-220701-B – 6AN to -6AN Hose Barb (1 needed)
FRA-495110-BL – 6AN O-ring to straight -4AN Adapter (1 needed)
SUM-220700-B – 4AN Hose Barb (1 needed)
SUM-220711-B – 90° -6AN to -6AN Hose Barb (1 needed)
SUM-800199 – 0-100 EFI fuel pressure gauge
SUM-G3138 – Fuel Pump

Air Intake System

SPE-9741 – 4” to 3.50” Reducer adapter
SPE-9771 - 4” hose coupling
SPE-9799 - 4” 90 ° intake tube
SPE-9705 - Mass Air Sensor filter adapter
KNN-RU-5149 – 4” ID x 6.50” long Air Filter

Other vendors

Autozone

2005 Ford Mustang GT Starter – DL3299S or similar



If not running A/C, a small 1-wire alternator can be used in the stock compressor location. If A/C is being used, the following alternator can be used with the brackets described.

2001-03 Honda Civic DX 1.7L MFI SOHC Alternator – 12308

Supplies

Oil – See instructions with engine - 8 quart
Coolant – 2 gallons of concentrate
Oil filter – 92 Ford Mustang, Fram PH8A or similar
Transmission fluid
Teflon tape



Information

These instructions assume that the customer has the Hot Rod Coyote Installation kit from Factory Five Racing



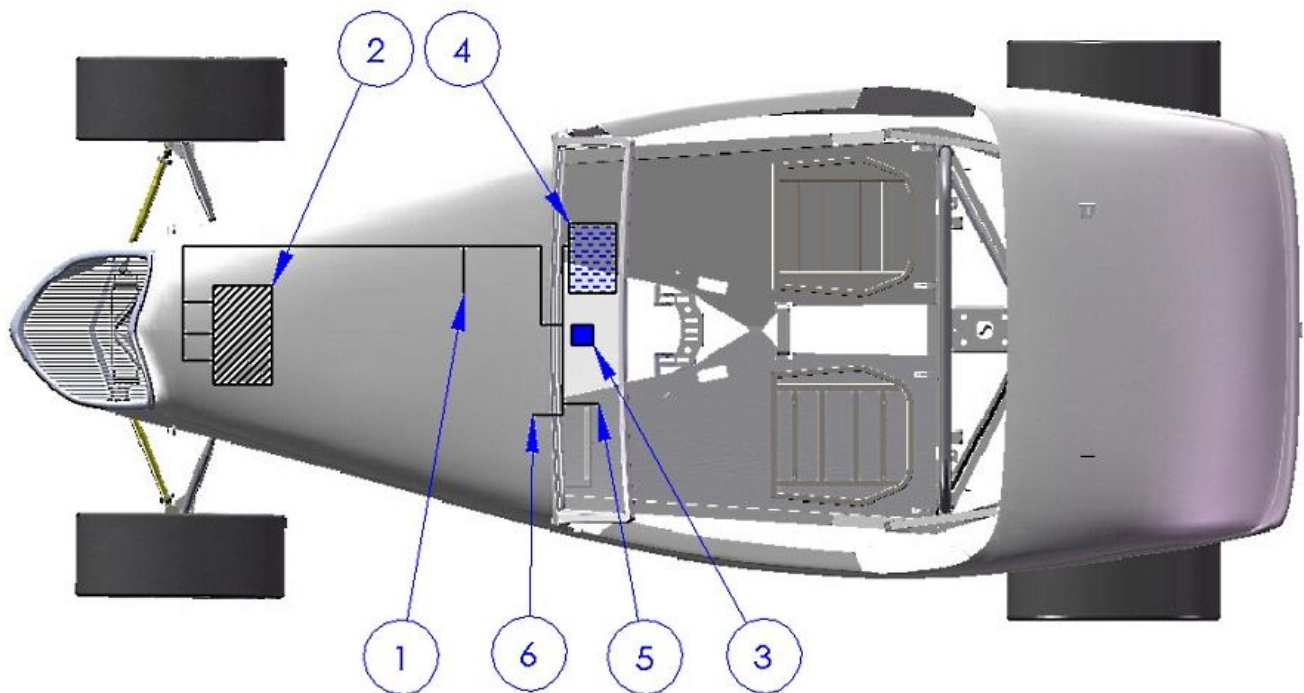

Use the following diagram as a guide for harness locations.

1	Engine starter
2	Engine computer
3	Power distribution
4	Black circuit board box
5	OBD 2 port
6	Accelerator pedal



Engine prep

Oil filter relocater

-  $\frac{3}{8}$ " Hex key, 8mm socket, ratchet, Teflon tape, ratchet extensions, $\frac{7}{8}$ " wrench, vise grips
-  Pipe fittings, oil filter relocater
-  The filter on the engine has a metric thread while the relocater does not.
-  Do not use the spin-on adapter in the relocater box, it has the wrong thread. Use the loose adapter.

Remove the oil filter that comes on the engine and discard.



Put the o-ring in the relocater groove and screw the spin-on adapter onto the block.



Use one of the hose adapters to turn the relocater if necessary so that the spin-on adapter is oriented front to back.



Use Teflon tape on the port plugs.

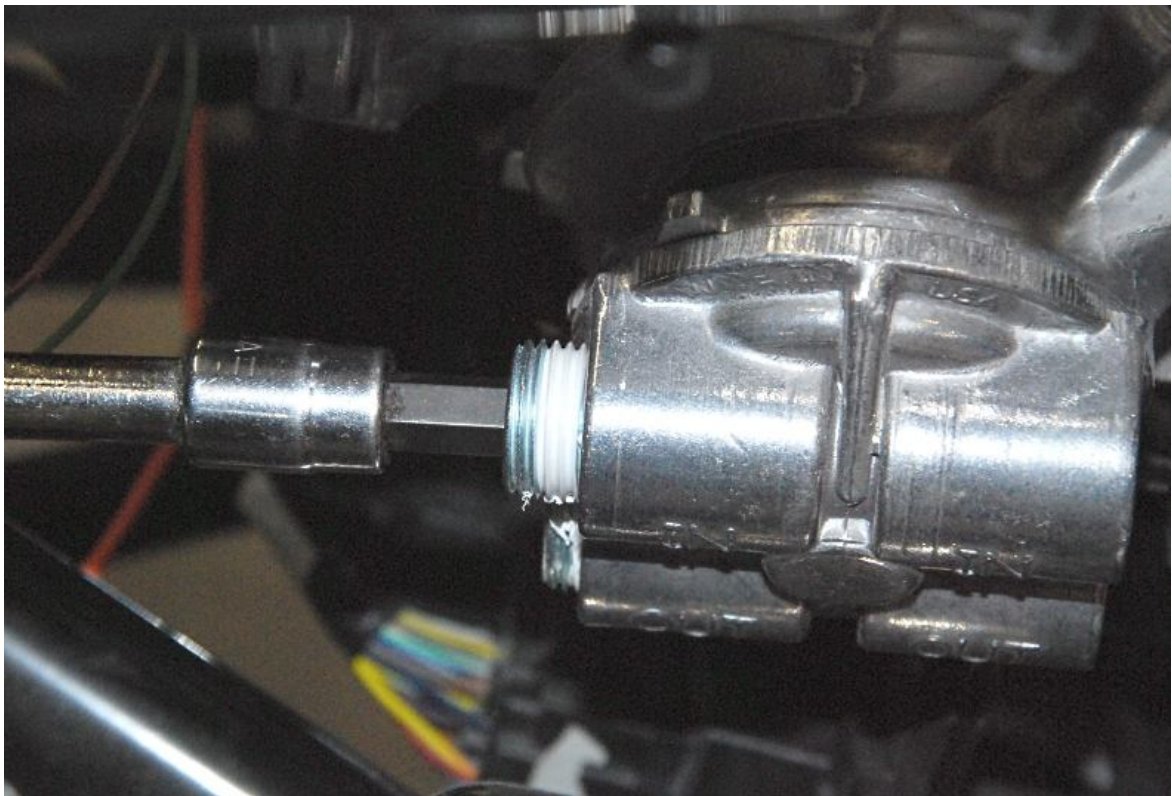

Screw the plugs into the rear of the spin-on adapter.



Use Teflon tape on the hose fittings.

Screw the hose fittings into the front of the spin-on adapter.

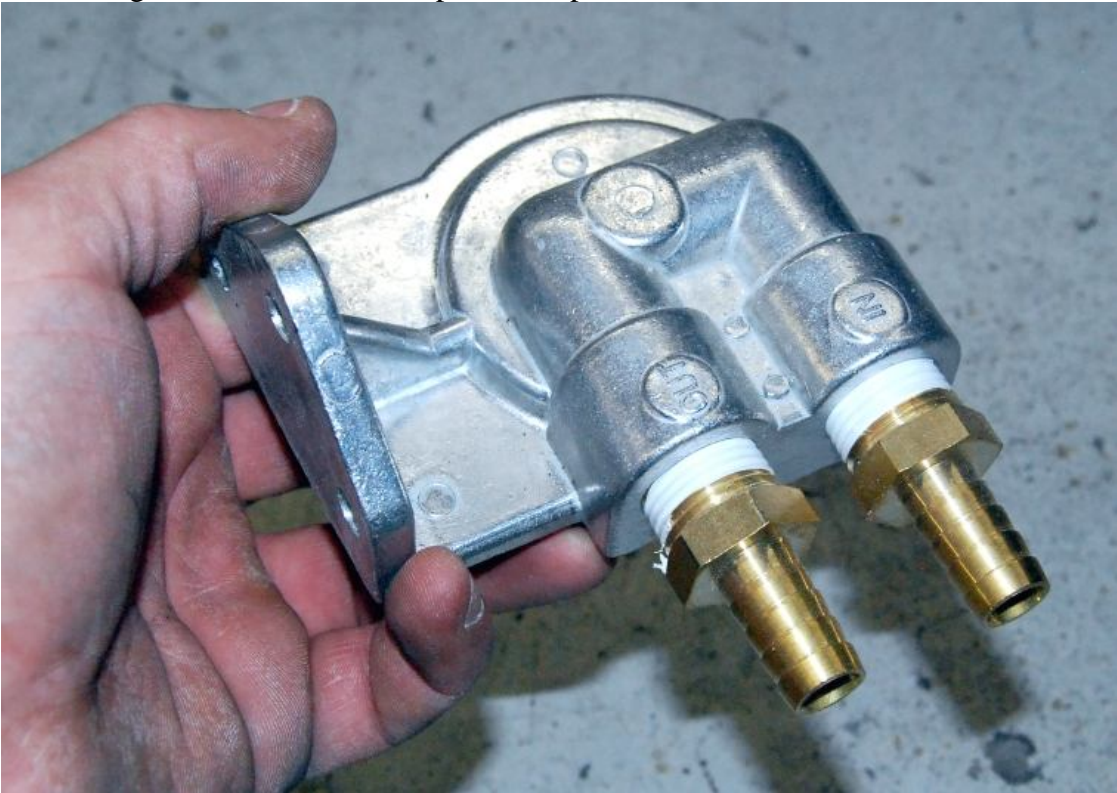

Screw hose fittings into the relocater.



Screw the threaded nipple into the relocater.

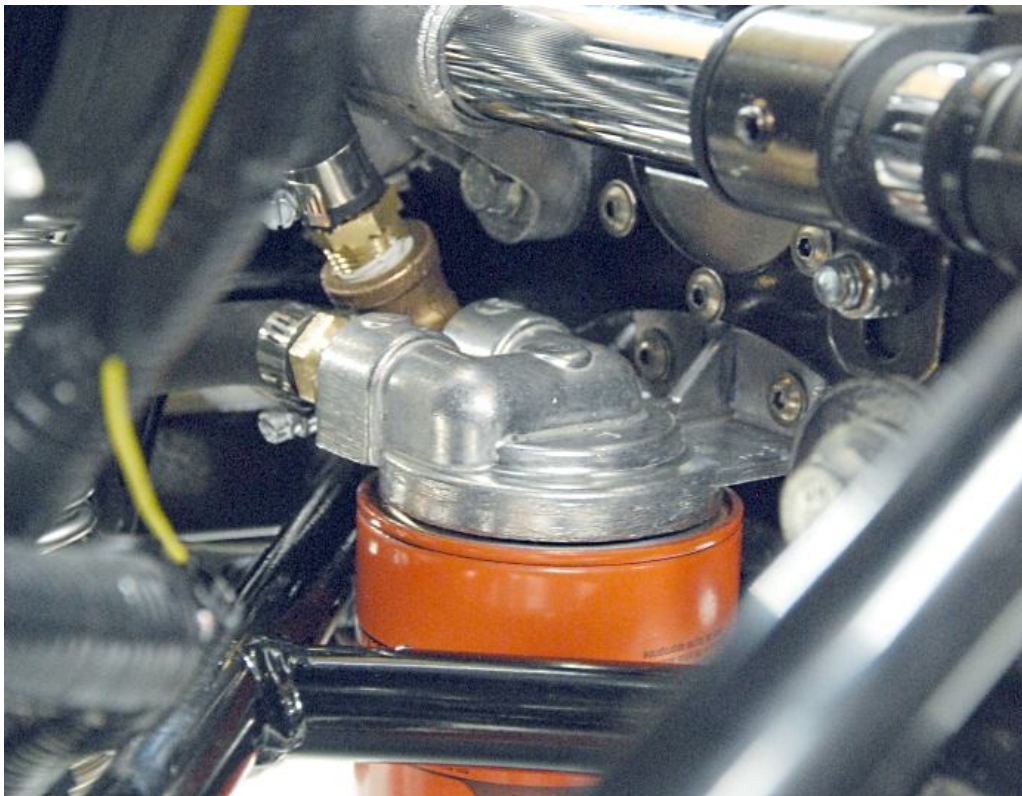

Decide on a location for the relocater. We located it under the steering rack in the center of the frame "X" so that the filter is accessible from under the car but is high enough to allow clearance. This did require an extra 90° fitting as shown in the picture.

Oil Pressure sender

- 🔧 Pipe fittings, Gauge assembly
- 🔧 H14 Hex key, 12mm deep, $\frac{13}{16}$ ", $1\frac{1}{16}$ " sockets, ratchet, Teflon tape, ratchet extensions, $\frac{3}{8}$ ", (2) $\frac{9}{16}$ ", $\frac{11}{16}$ ", $\frac{7}{8}$ " wrenches, vise grips



Remove the stock oil pressure sender from the block located behind the alternator.



Use Teflon tape and install the oil pressure gauge sender.



From the gauge box, screw on the 1/4" NPT adapter.



Put Teflon tape on the adapter then screw on the “T” adapter fitting.



Put Teflon tape on the 1.50” NPT tube.



Use vise grip pliers to attach the 1.50" tube to the sender assembly.



Use Teflon tape and install the pipe fitting assembly in the oil pressure location on the engine so that the side port faces up for now.

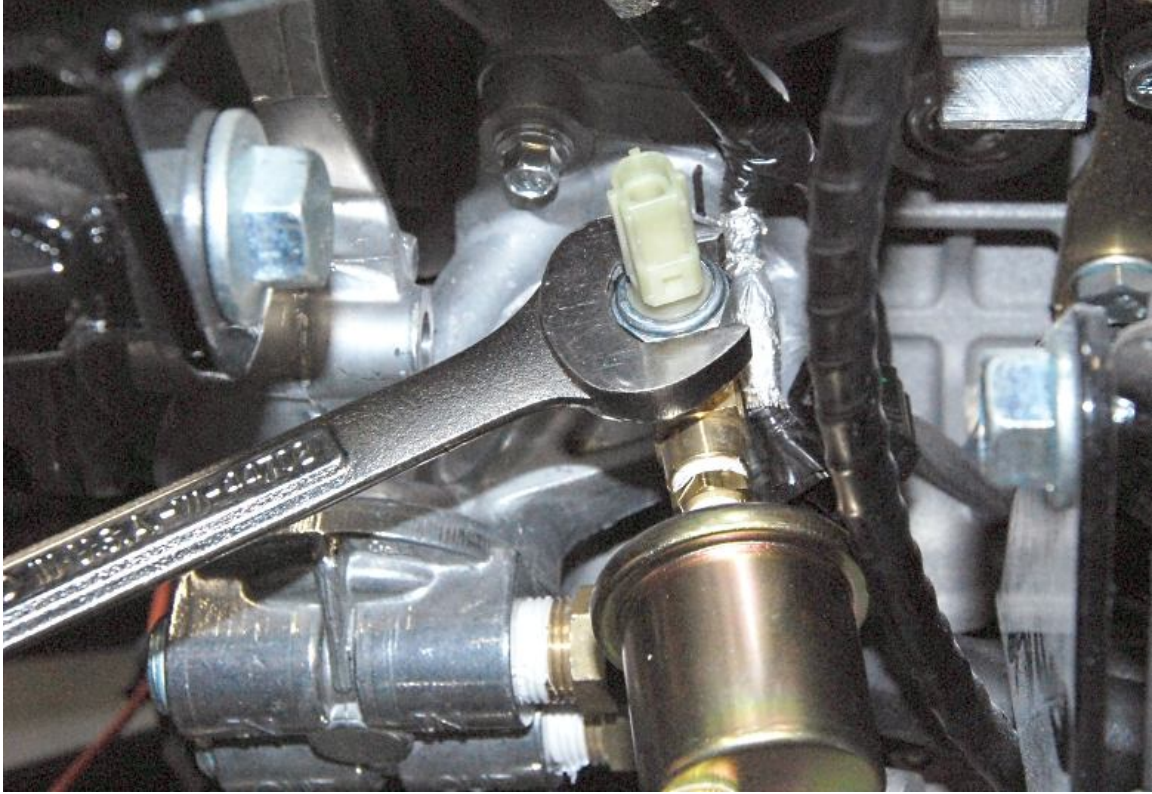

Use Teflon tape and install the OEM oil pressure sender in the side of the T fitting.

Water Temp Sender

- ✂ H14 Hex key or socket, 1¹/₁₆” socket, 12mm deep socket, extension, ratchet, Teflon tape
- 🔧 Water temp gauge sending unit



Remove the $\frac{3}{4}$ " NPT plug from the side of the block using a H14 Hex key or socket.



Put Teflon tape on the $\frac{3}{4}$ " NPT to $\frac{1}{2}$ " NPT adapter.

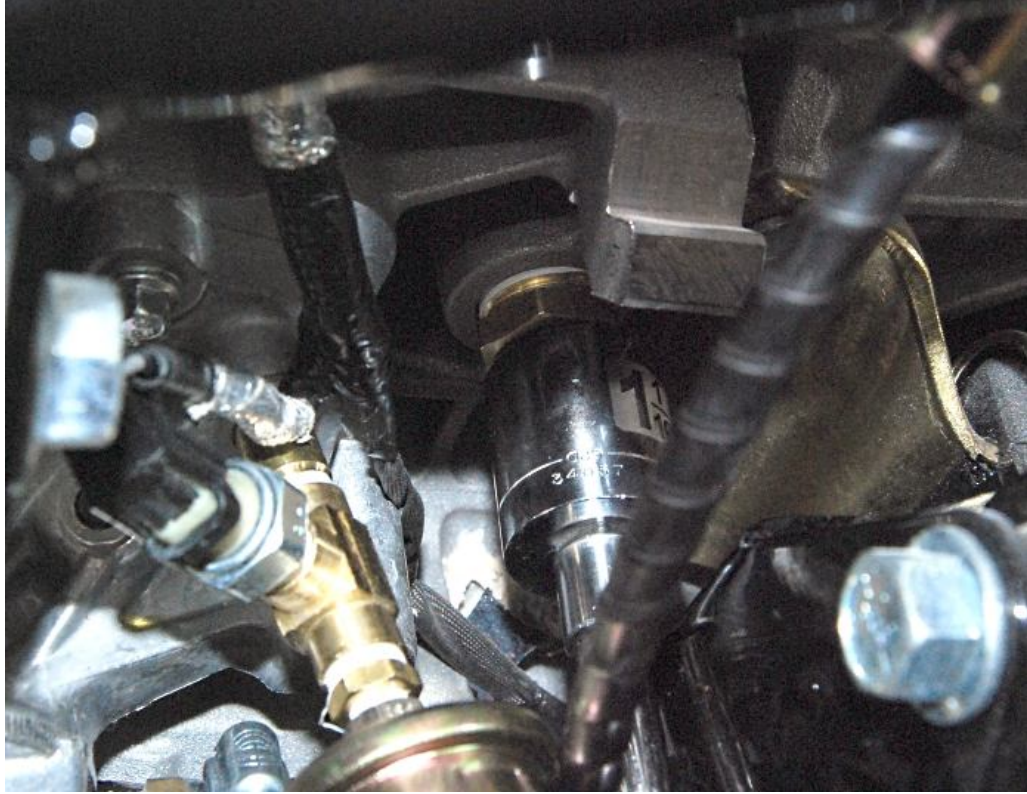

Screw the adapter into the block using a 1 1/16" socket.



Use Teflon tape on the 1/8" NPT to 1/4" NPT adapter included with the gauge.

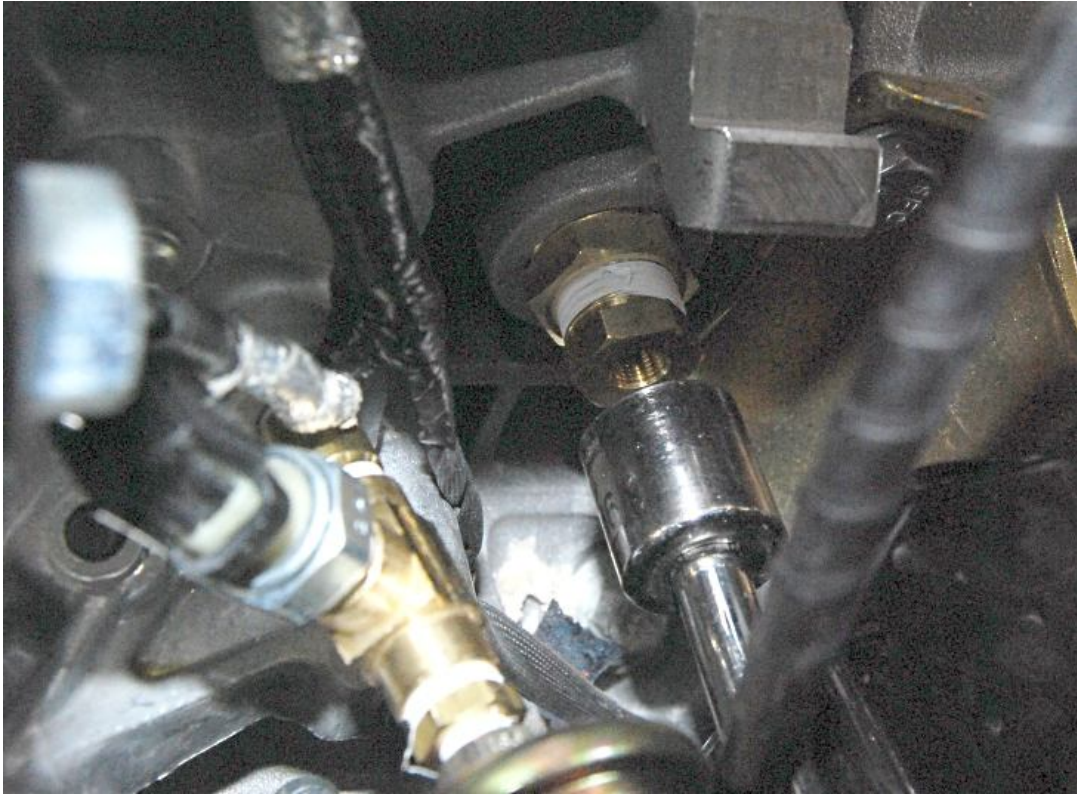

Screw the adapter into the larger adapter on the block.



Put Teflon tape on the sending unit.

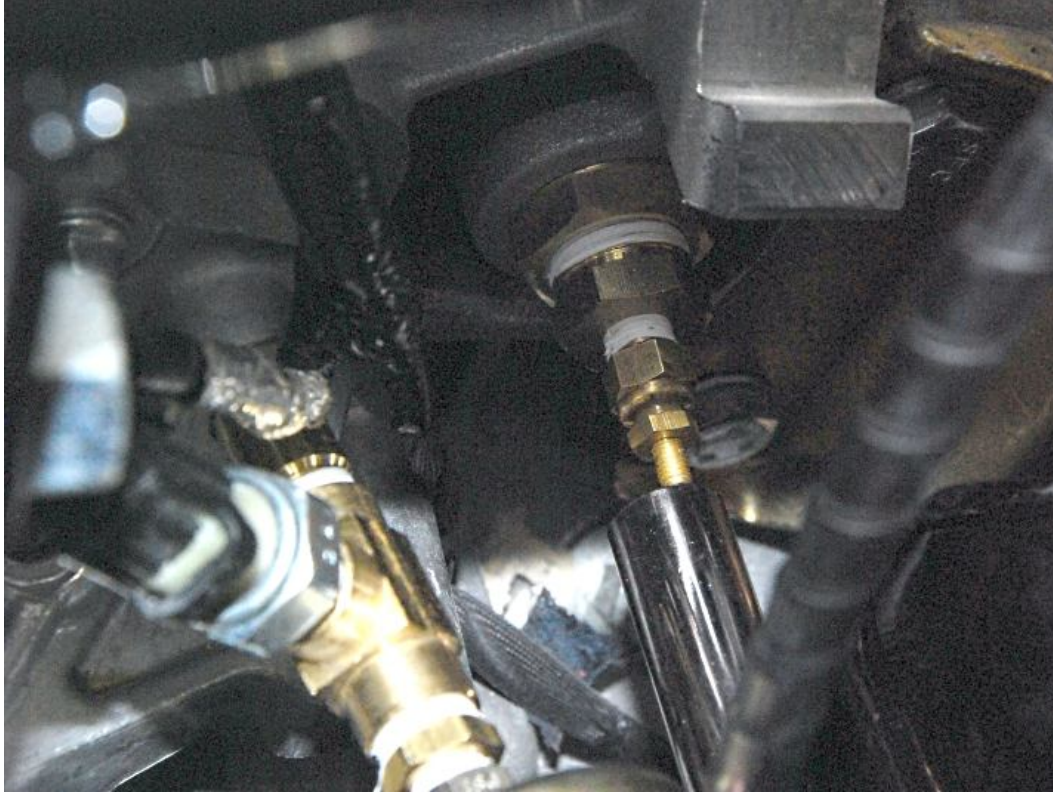

Use a 12mm deep socket to screw the sender into the adapters.

Engine Bolts

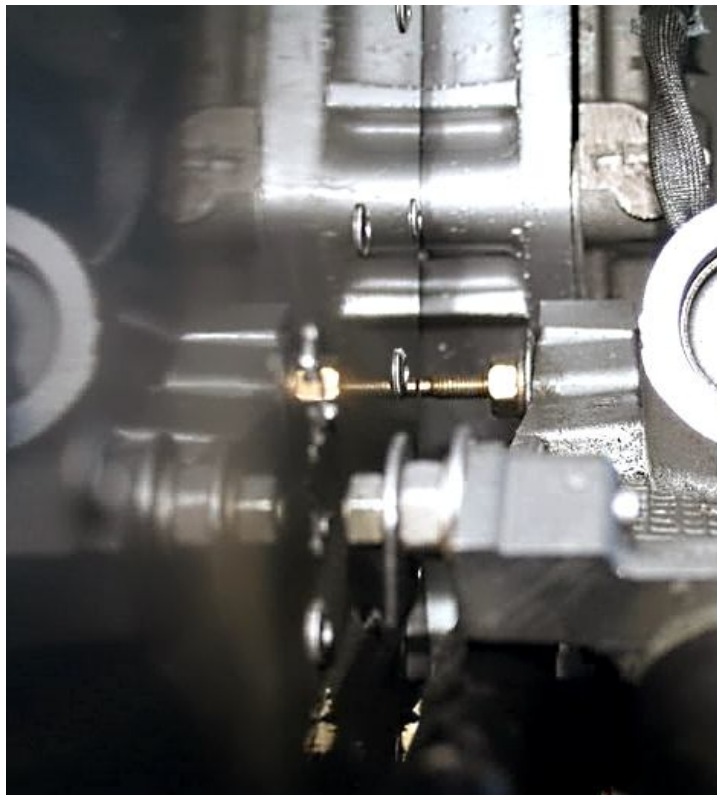

The engine ends up extremely close to the firewall. Cut any extra length off the bolts to prevent damaging the firewall.

Alternator Boss



Hack saw or jig saw



Use a hack saw or sawzall with a course wood blade, a fine metal blade will get gummed up with the aluminum.



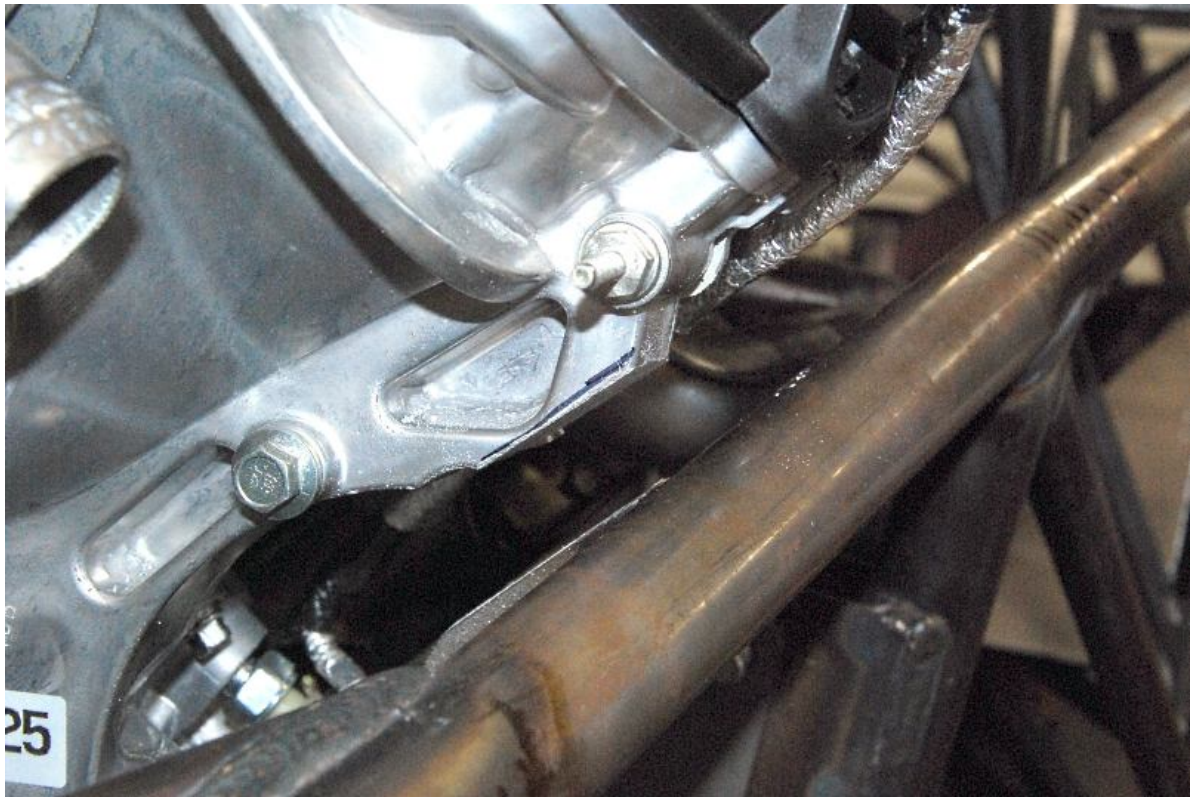

Use a Marker to mark the top stock alternator boss on the driver side as shown. It will hit the frame otherwise.



Cut the boss on the line marked with a jig saw

Transmission Prep

-  Hack saw or Reciprocating saw, 3/4" socket, ratchet
-  Transmission, Polyurethane engine/transmission mount kit
-  The two aluminum spacers provides are not used.



If you are using a Tremec 3550, TKO 500 or, a TKO 600 you will need to trim off the unused mounting boss on the bottom of the case.



Trim it flush or just below the pad for the transmission mount.

If not already done, install the flywheel and clutch on the engine.



Remove the vibration damping weight from the clutch fork, it is not needed.

Attach the bellhousing and clutch fork to the engine.

Attach the transmission to the engine.

Engine/Transmission Installation

If electric steering is installed, undo the mounting bolts and rotate the motor down out of the way.



Install the engine and transmission per the assembly manual.



Attach the polyurethane transmission mount to the frame mount and transmission using the 1.09" and 0.32" spacers provided.



If using electric steering, reattach the motor mounting bolts. Make sure there is some clearance between the oil pan and motor. Redrill/slot one or two of the mounting holes if necessary.

Fuel System



Fuel pressure regulator, fittings, fuel hose, hose clamps, high pressure fuel pump

The Coyote engine requires a 255 lph high pressure fuel pump such as the Summit Racing SUM-G3138 Fuel Pump. Either an inline pump or intank pump can be used depending on preference.



Mount a fuel pressure regulator to the firewall and connect the appropriate fittings, the return is on the bottom.

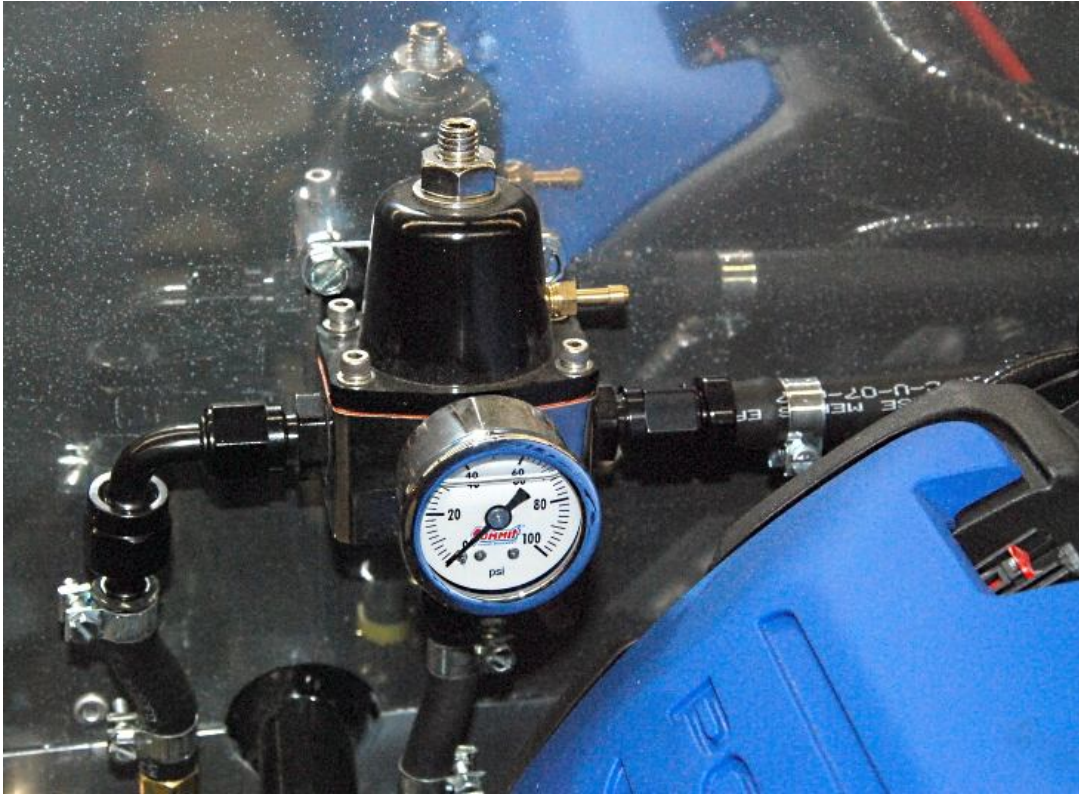

Push the $\frac{3}{8}$ " fuel line onto the right side of the regulator then attach a hose clamp and run it over to the engine fuel rail.

Push the white fuel line connector onto the fuel rail.

Hold the fuel line up to the connector and cut it to length with a razor knife.

Remove the fuel line connector.

Slide a hose clamp onto the hose then push the fuel line connector into the hose and tighten the clamp.



Push the white connector onto the fuel rail.

Cut a 2.50" section from the length of 1/2" hose provided.

Assemble the 1/2" to 5/32" 90 degree adapter.

Push the 1/2" side into the short section of 1/2" hose and fasten with a hose clamp.

Slide a second hose clamp onto the hose.

Push the 1/2" hose onto the vacuum manifold port on the back of the intake so the small end points towards the regulator and tighten the hose clamp.

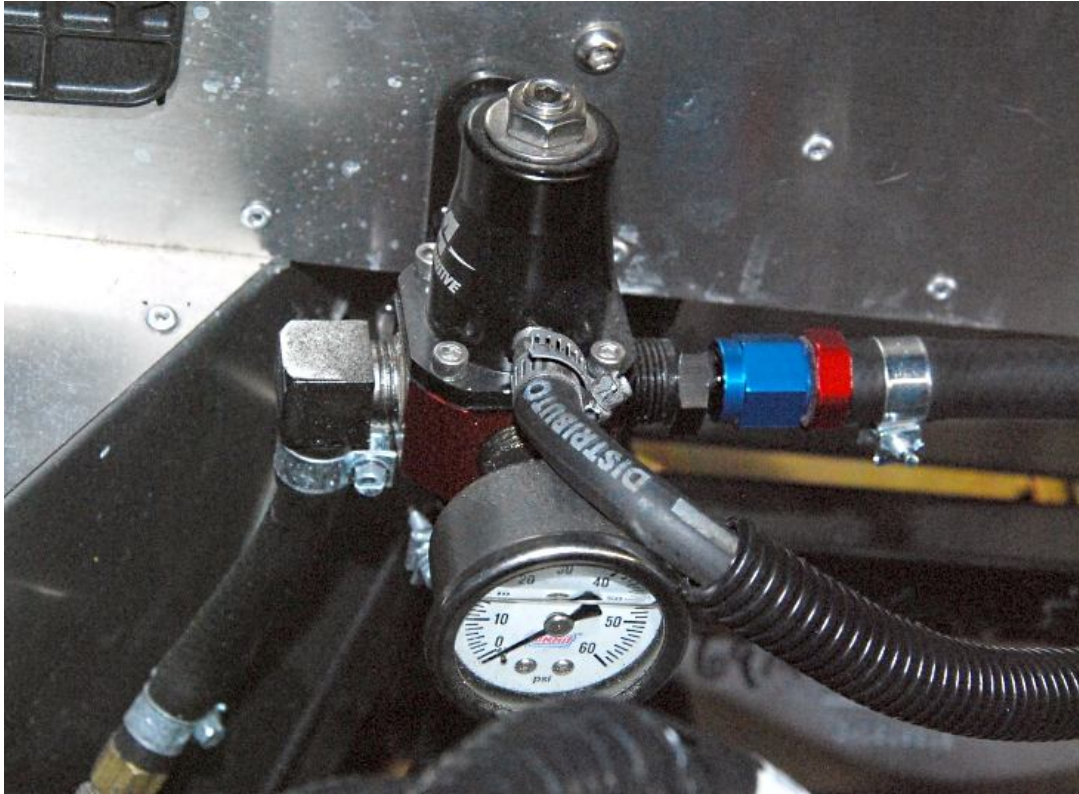

Push the vacuum line onto the fuel pressure regulator.

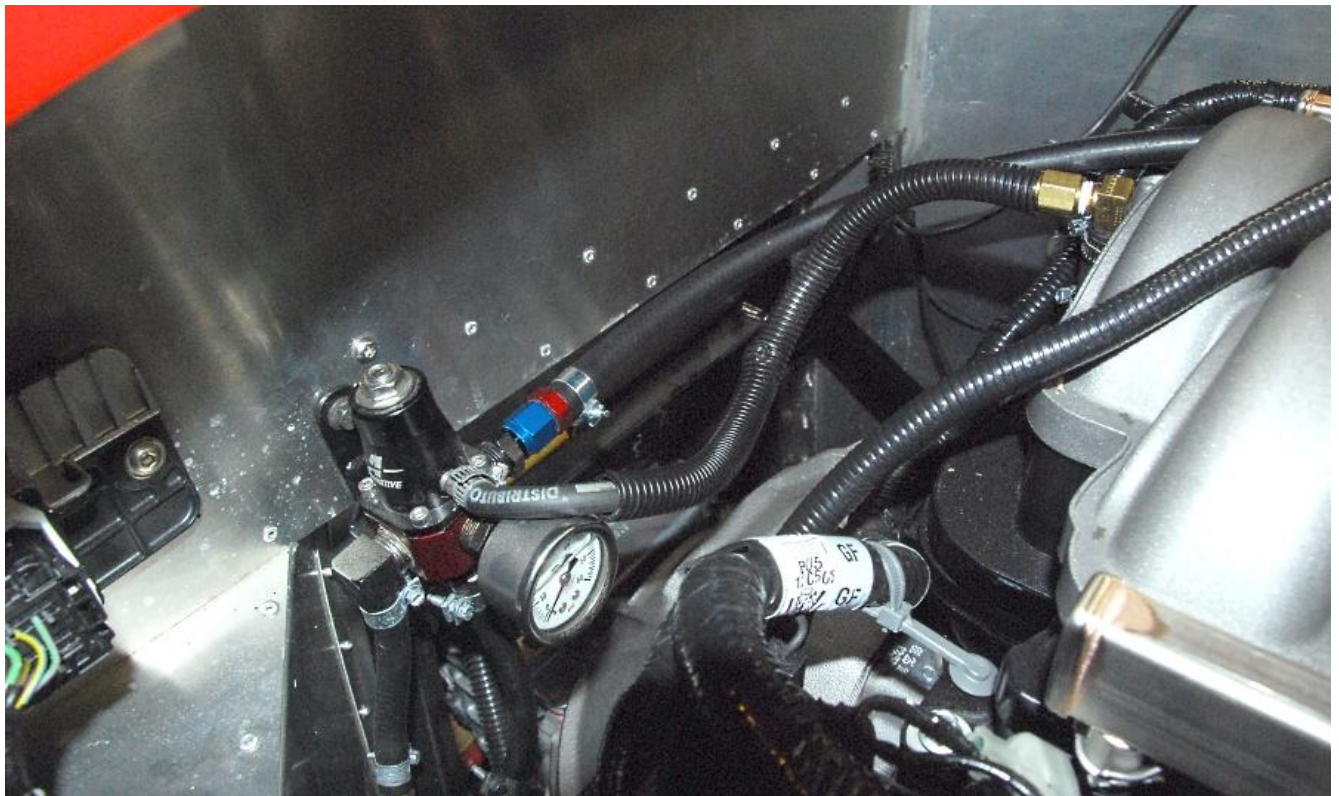

Push the vacuum line onto the hose adapter.

Cooling system

- ✂ Razor knife, flat head screwdriver, wire cutters, hack saw, marker
- 🔧 Stainless radiator hose kit

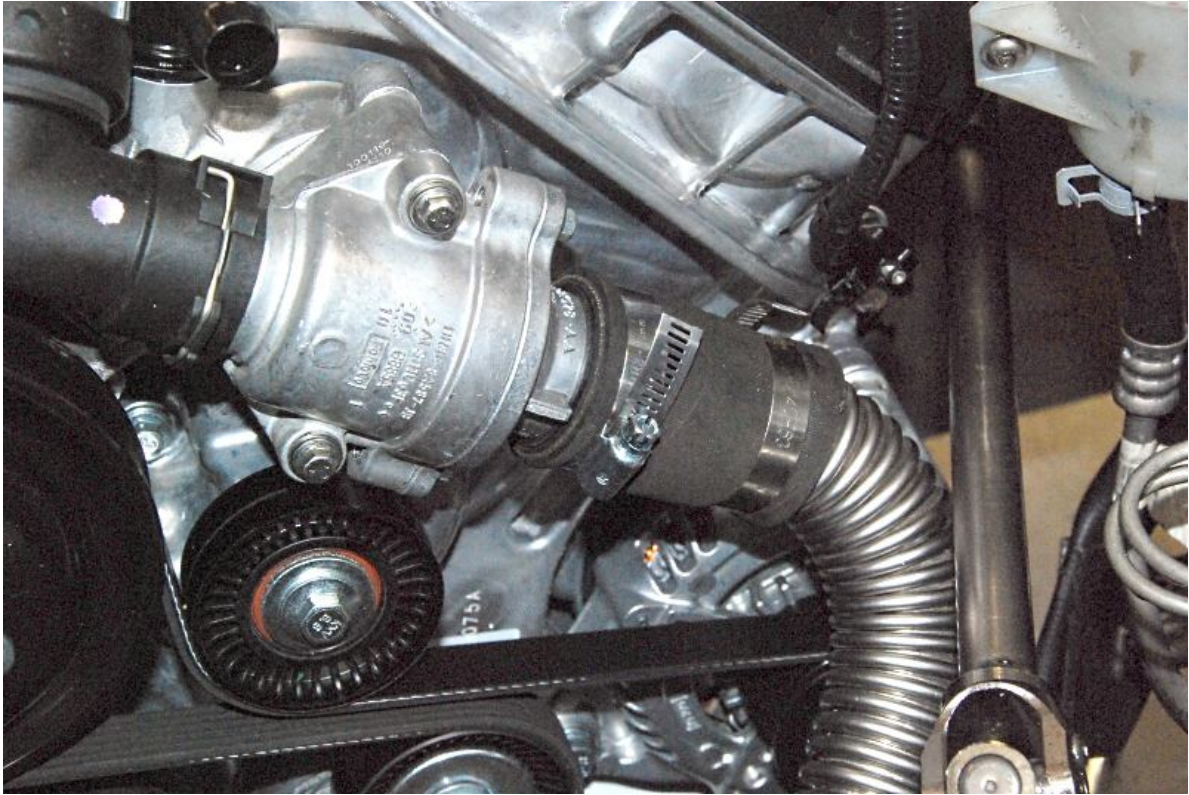

Push the correct size adapters onto to the thermostat housing with a length of the stainless hose.



Route the stainless hose around towards the center of the frame, down then straight forward to the lower radiator outlet and mark the hose for cutting.

Remove the stainless hose and cut it where marked with a hack saw.
Reinstall the hose.



Cut the plastic clamp off the stock upper hose.



Cut and remove the rubber hose from the plastic adapter.



Attach one of the kit hose adapters to the plastic adapter

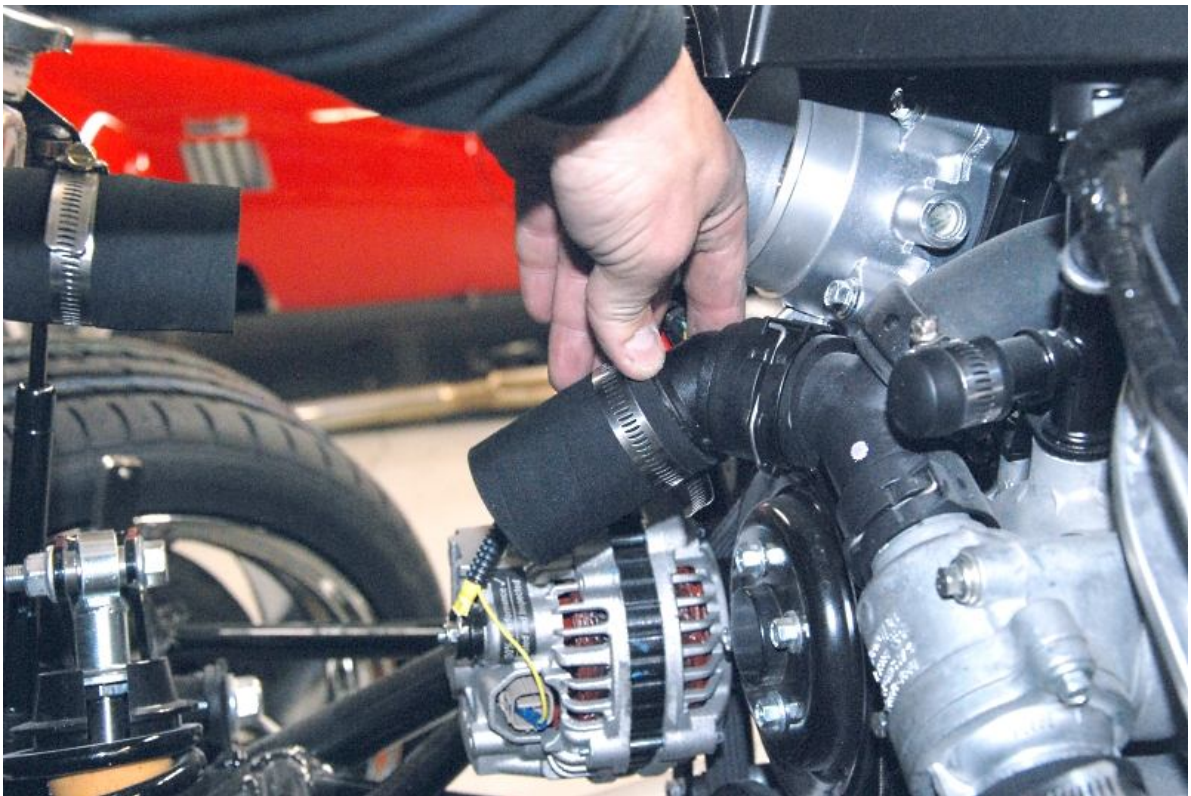

Push the adapter onto the engine.

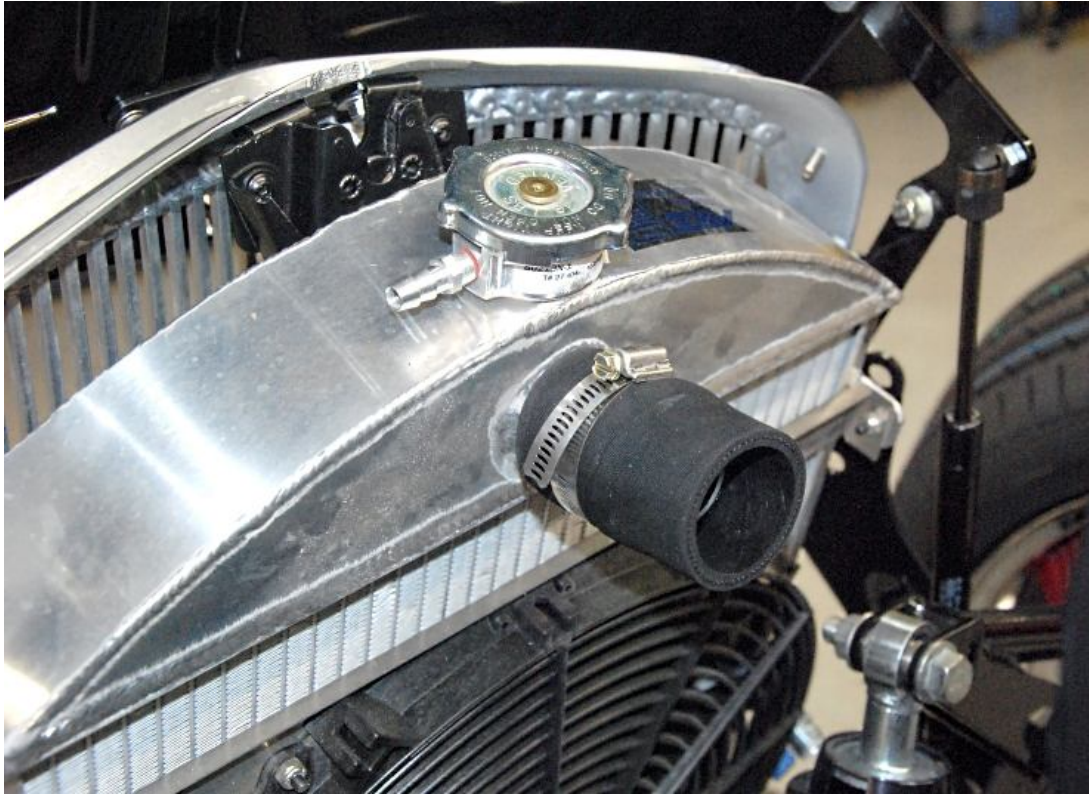

Attach another hose adapter to the radiator.

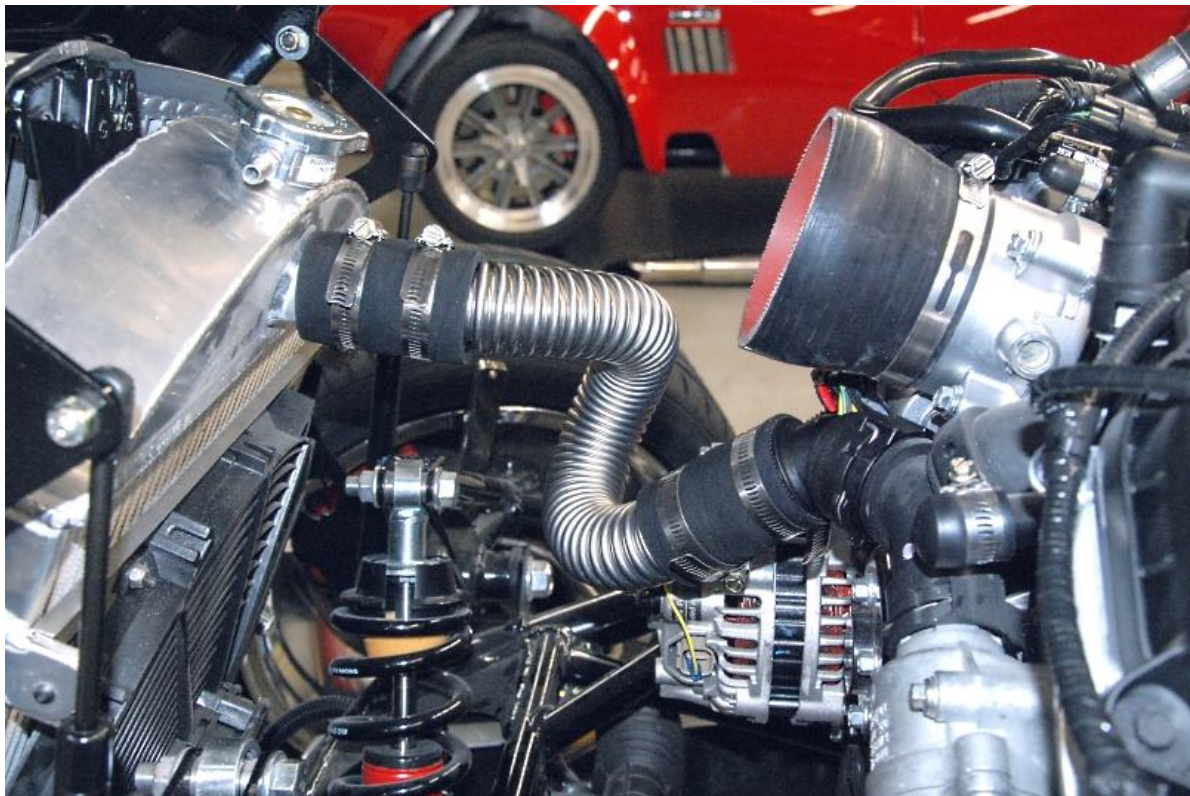

Route and cut the radiator hose so that the hose curls towards the right side of the car not the left (the air filter goes there).

Push the bypass caps onto the tubes to the left of the throttle body and hose clamp the lower one.

- ✎ For air bleeding later, remove the top cap until coolant starts going up the tube then recap and hose clamp.
- ✎ This top one is one of the heater core hose locations if running a heater and A/C.



Push and hose clamp the small coolant barb behind the 3/4" coolant tubes.



Cap and hose clamp the 3/4" coolant.



This is the other heater core location if running a heater and A/C.

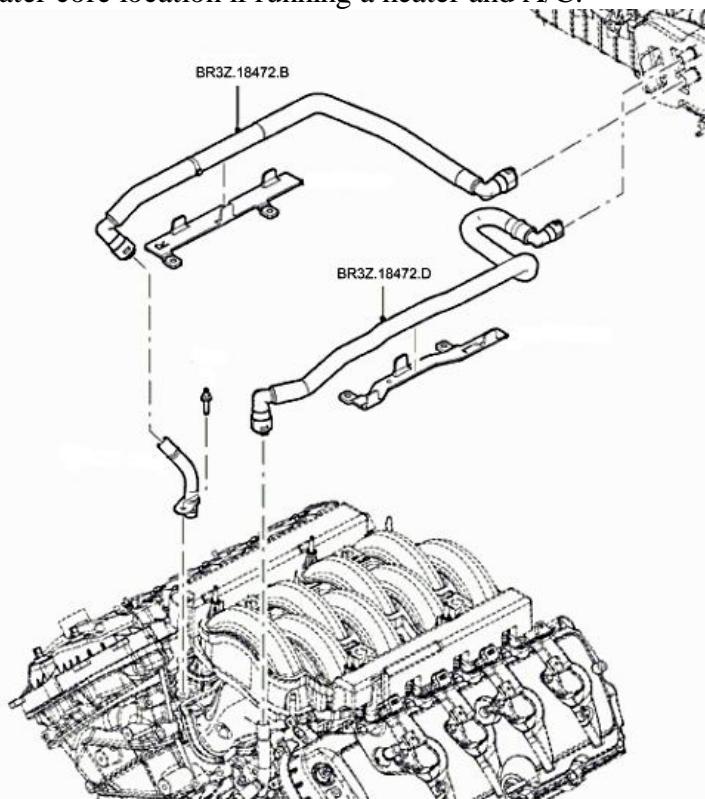

If running a heater and A/C, the stock Mustang heater hoses work well. The numbers for the hoses are:

BR3Z.18472.B
BR3Z.18472.D

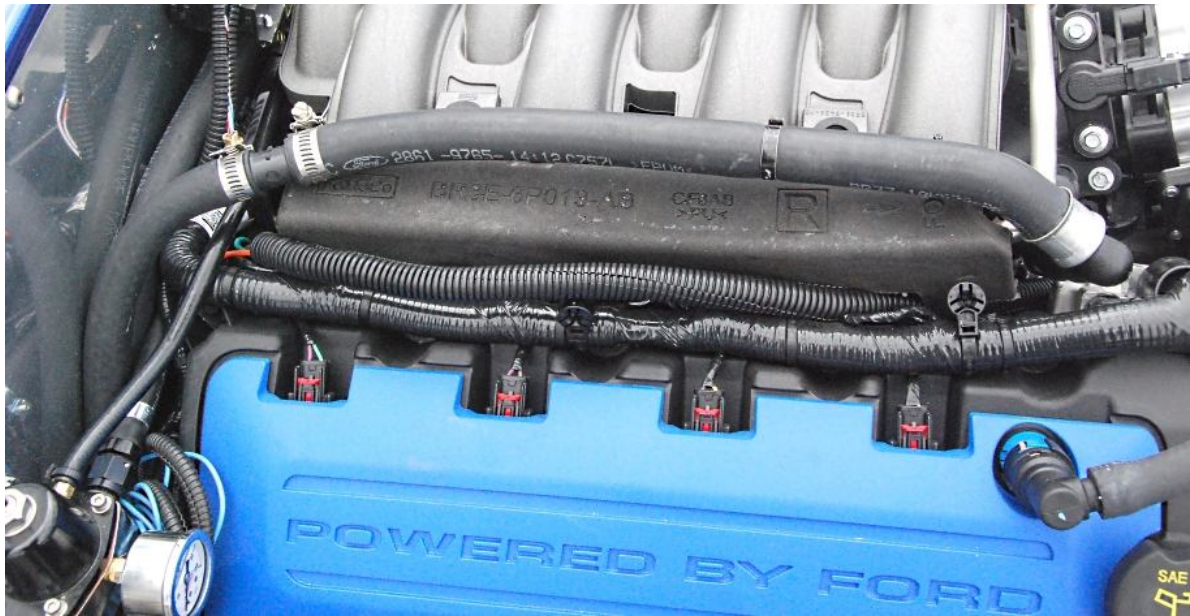

Vacuum ports and PCV vent

- ✂ Flat head screwdriver, razor knife, WD40
- 🔧 Vacuum plugs, PCV lines, ½” rubber hose, T connector
- 👤 There are a couple ways to route the PCV hose depending on your emission requirements (tough or relaxed)

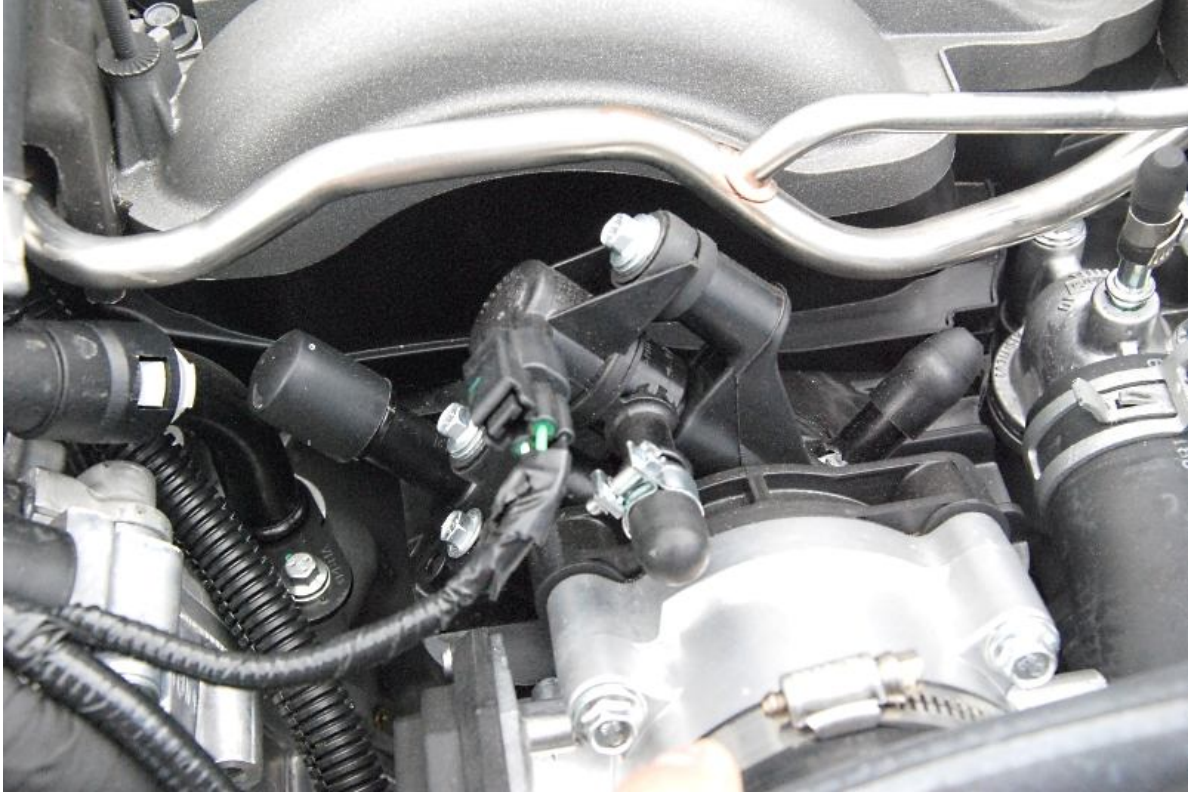

Block off the vacuum ports and fuel evaporator intake tube just behind the throttle body.

Tough emissions



If not already done, connect the right side stock PCV hose from the valve cover to behind the throttle body.

Install a 1/2" barb fitting in the intake tube after the mass air meter but before the throttle body.



Carefully cut the 90° PCV fittings out of one of the pcv lines without damaging the barbs.



Push the 1/2" heater hose onto the PCV fitting.



Attach the fitting to the left side valve cover.

Run the hose over to the intake barb and cut the hose to length.
Use a hose clamp to attach the hose to the intake tube.

Relaxed Emissions



Carefully cut the 90° PCV fittings off the pcv lines without damaging the barbs.



Spray some WD40 into the end of the hose and push the 1/2" heater hose onto one of the PCV fittings.



Push the fitting onto the left valve cover and run the hose forward just left of the throttle body.

Cut the hose at the back of the engine with a razor knife.

Push the remaining hose onto the other 90° PCV fitting again using WD40.



Push the fitting onto the right valve cover and run the hose around the front of the engine to the left side.

Insert the “T” fitting into left side hose.

Cut the Right side hose so that it will go onto the “T”.

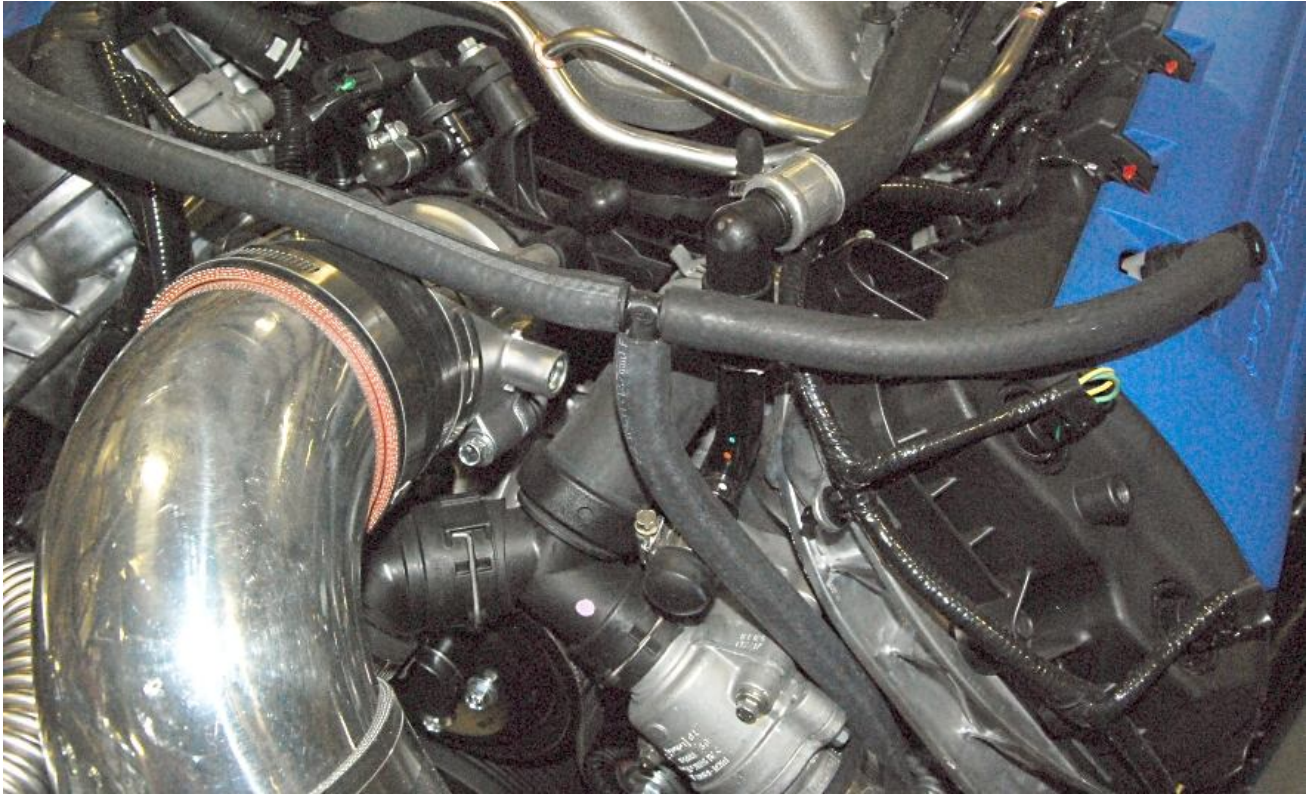

Push the right side hose onto the “T”.



Push the remainder of the hose onto the third leg of the “T” and run it down behind the coolant inlet.



Run the hose under the oil pressure sender then over the electric steering (if used) and cut the hose.

Steering shaft

- ✂ Hack saw, $\frac{7}{16}$ " socket, ratchet, $\frac{3}{16}$ " drill bit, drill, $\frac{3}{16}$ " hex key
- 🔧 Hot Rod steering parts

Remove the middle steering shaft that goes from the firewall to the lower steering bearing in the engine bay. Cut the shaft into two sections, $8\frac{7}{8}$ " for the lower shaft and 4.25" for the upper shaft.

Assemble the two shaft pieces with the included steering joint with the short half of joint on the long shaft.

Slide the $\frac{3}{4}$ " pillow block onto the long shaft with the bearing lock pointed away from the steering joint.

Assemble the shaft on the frame so that the ends of the shafts are flush with the inside of the joint.

Loosely attach the tube clamps to the 1" round tube near the steering shaft.

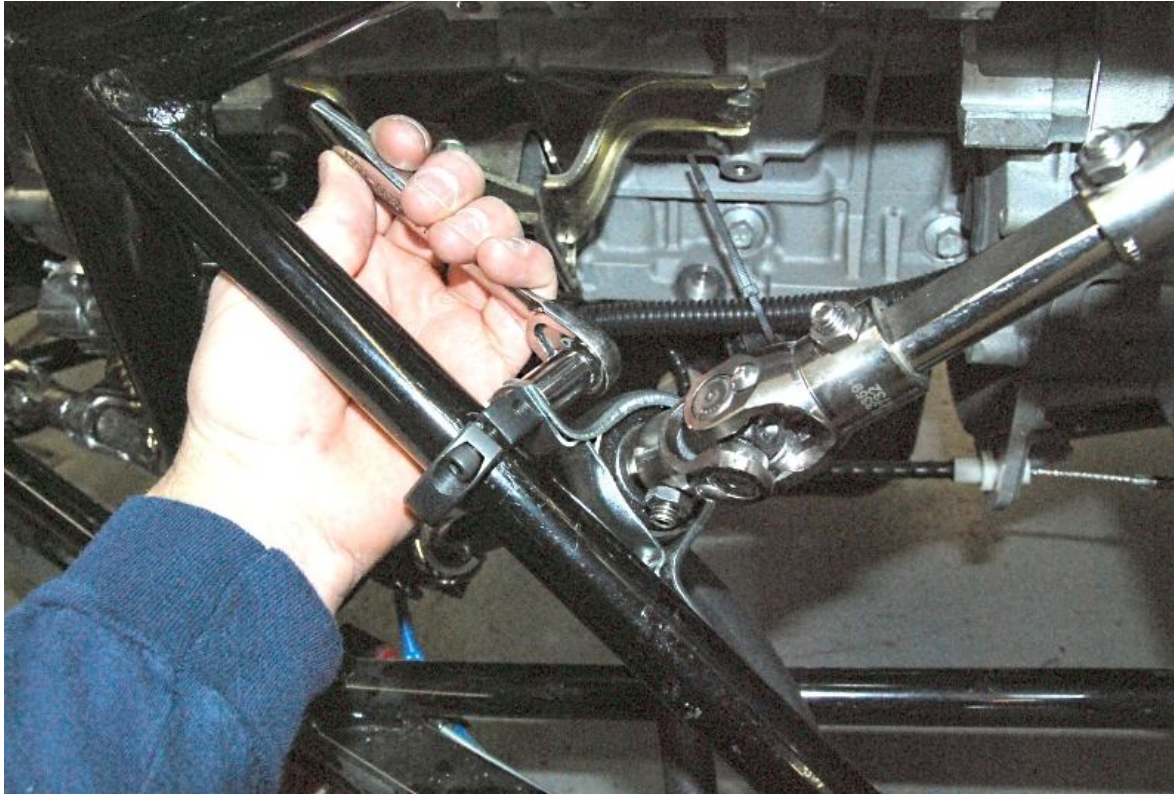

Loosely attach the pillow block to the tube clamps, the screws will not tighten because of the tube.

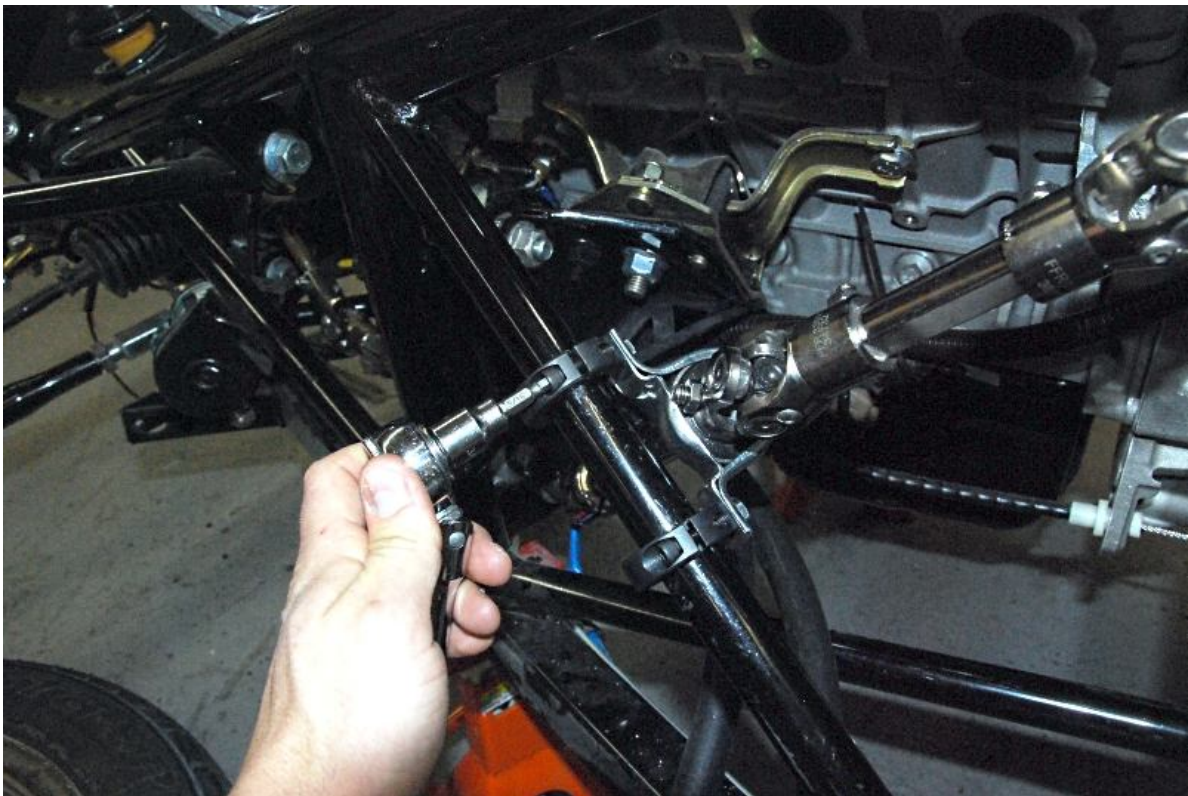

Locate the tube clamps on the tube so that the shaft is as straight as possible and then tighten the clamps.

Remove the pillow block screws and use a marker or small drill bit through the screw hole to mark the location on the 1" tube.

Remove the tube clamps.

Drill the marked locations using a 1/4" drill bit. This will allow the pillow block mounting screw to go into the tube and also prevent the tube clamps from turning or moving if they loosen for some reason.

Reassemble the tube clamps and pillow block on the tubes using the pillow block mounting screws in the drilled holes to locate them.



Tighten the set screws on the steering joint and pillow block.

Wiring



Soldering iron, solder, electrical tape, wire cutters, wire strippers



Use the diagram at the beginning of these instructions for general routing and component location.



See instructions for the Ford Racing Speed dial for installation of this part.

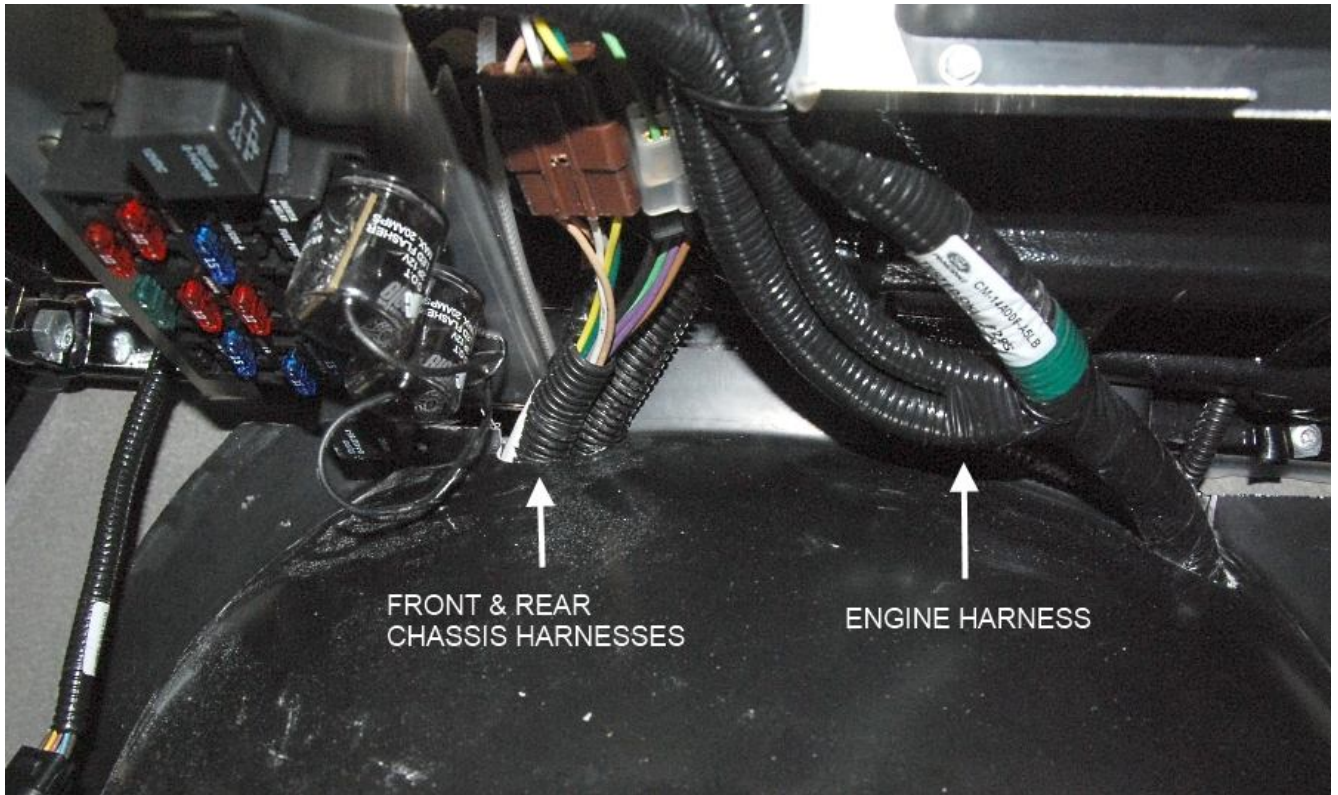

The main wiring harness will exit the cockpit towards the right side of the transmission tunnel.

Black circuit board box

✂ Small and Large Philips head screwdriver

Open the black box and remove the nut on the post marked “fan”.



Put the orange wire ring connector onto the post.

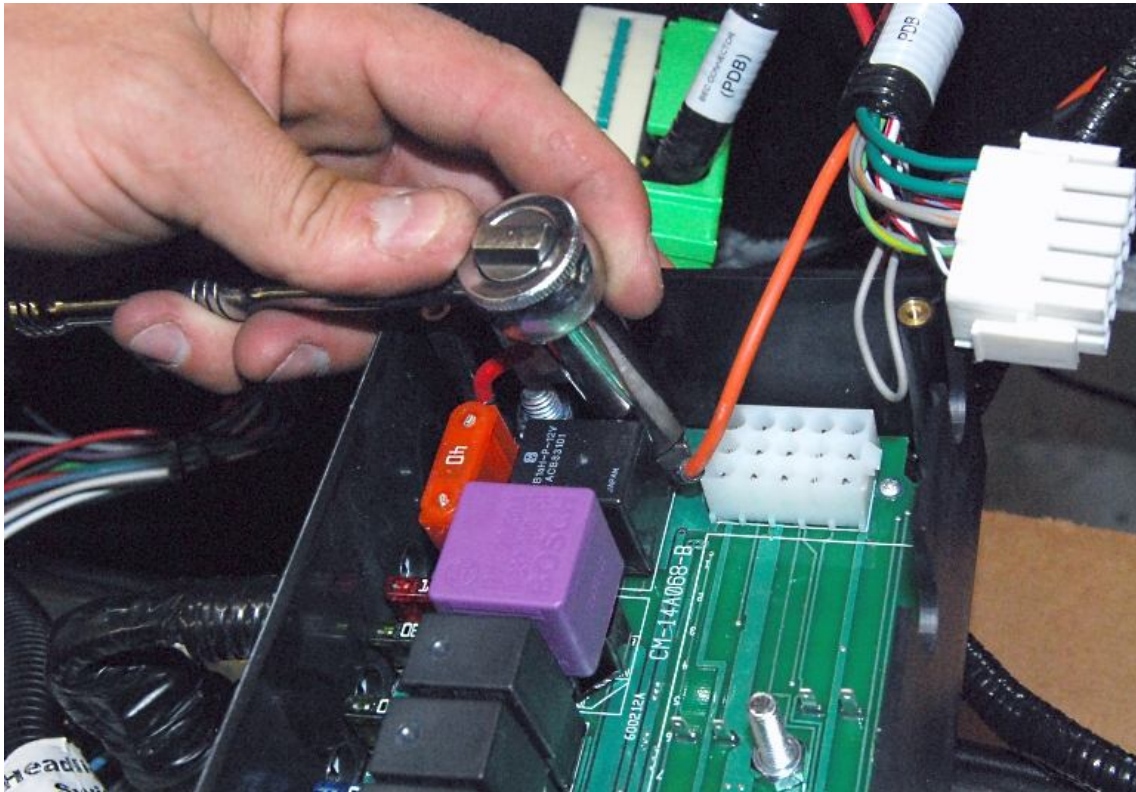

Tighten the nut on the fan post then bend the ring connector up so the wire clears the white connector.

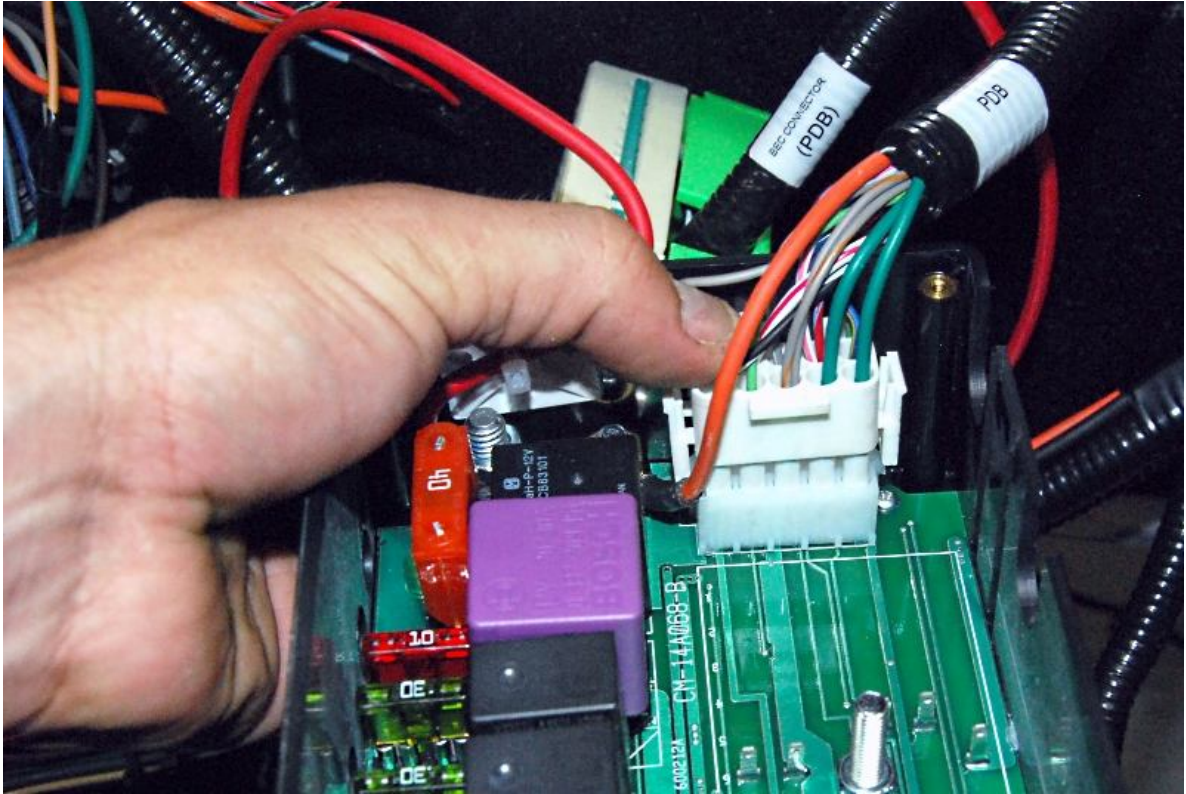

Push the white multipin connector onto the matching connector on the circuit board.

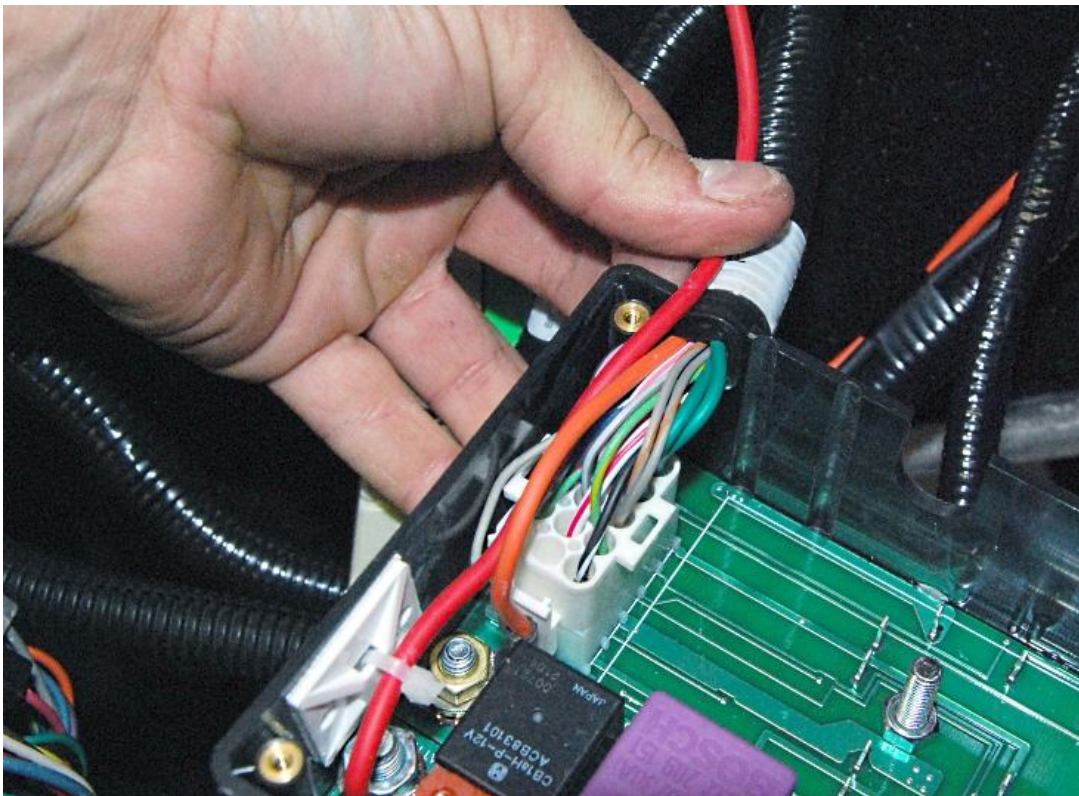

Run the white plug wires and the orange fan plug out of the box in the slot provided near the plug.

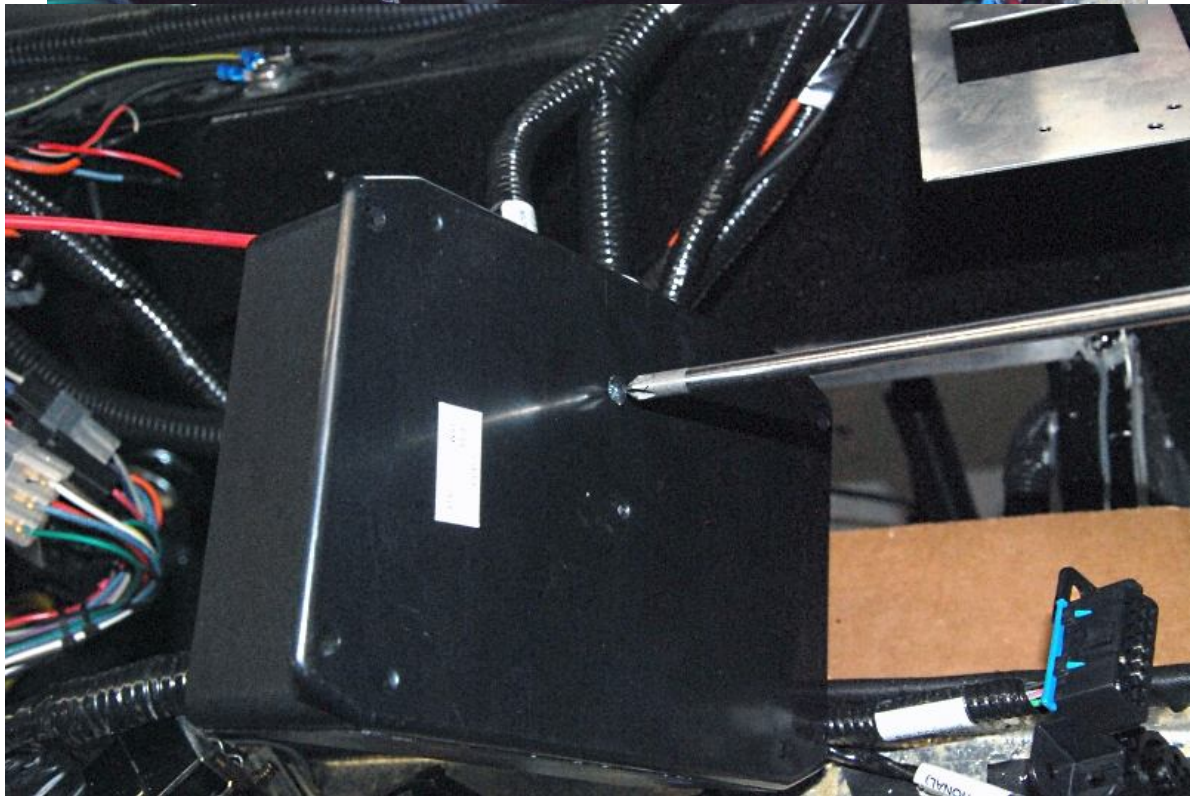
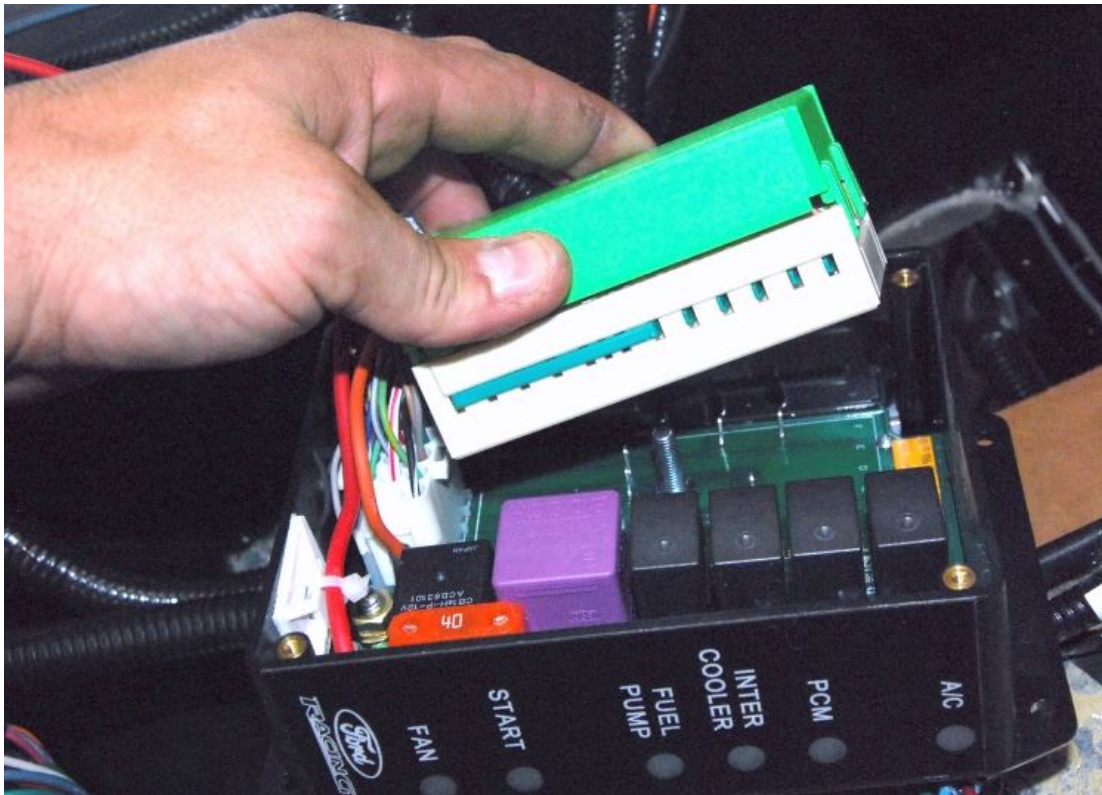

Connect the green power plug inside the box. It gets attached using a large Philips head screwdriver through the bottom of the box.

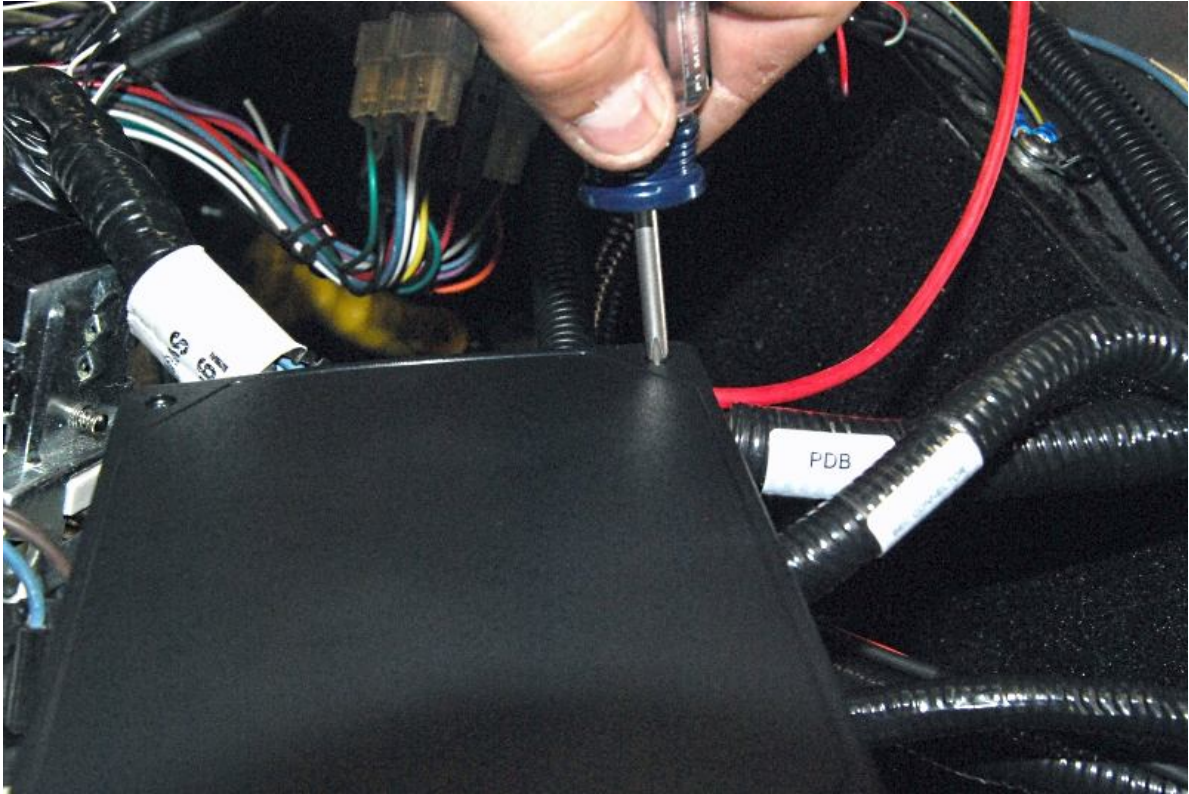

Reattach the top of the box.

Find a location on the frame to mount the box, we suggest to the right of the center of the car on the tubes behind the firewall. If using an A/C unit, there is enough room behind the dash to mount the box to the A/C unit. In the following picture an aluminum piece was used with $\frac{1}{4}$ " spacers to pick up existing threaded mounting holes and the foot vent area on the A/C unit.



Attach the black box to the frame or mount using some of the self tapping aluminum screws used to hold the aluminum to the frame during shipping.

Fuel Pump



Remove the fuse from the fuel pump circuit on the chassis harness fuse panel.

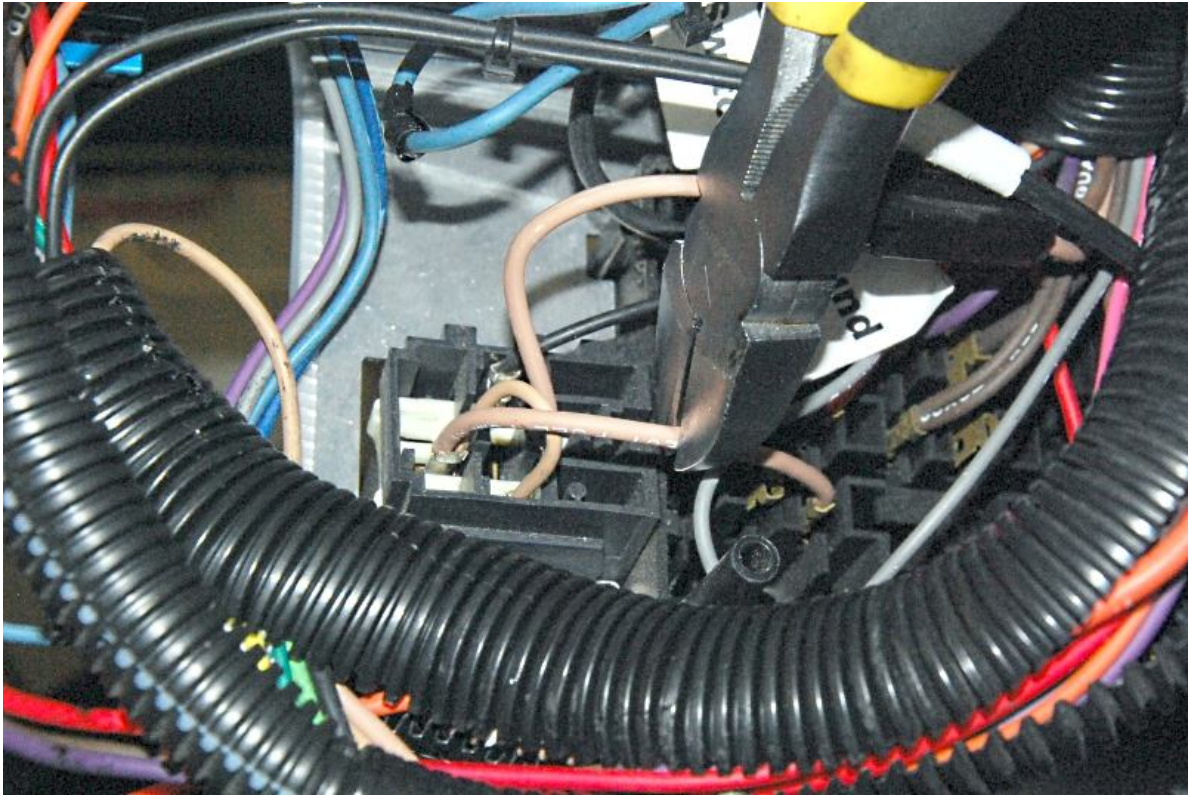

On the back of the fuse panel, cut the tan wire going from the relay to the fuse area.

Route the Coyote harness fuel pump green wire to the back of the chassis harness fuel panel.

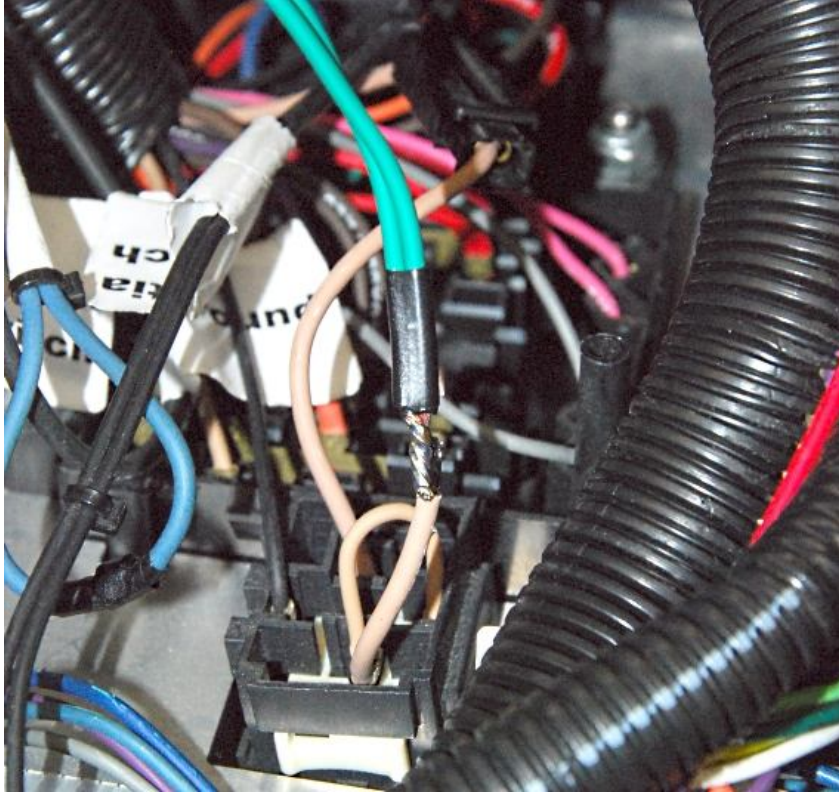

Cut the wire to length and solder the tan and green wires together.

Neutral Safety switch

If not using the neutral safety switch in the Coyote harness, route the wire (blue/yellow) to a ground on the chassis.

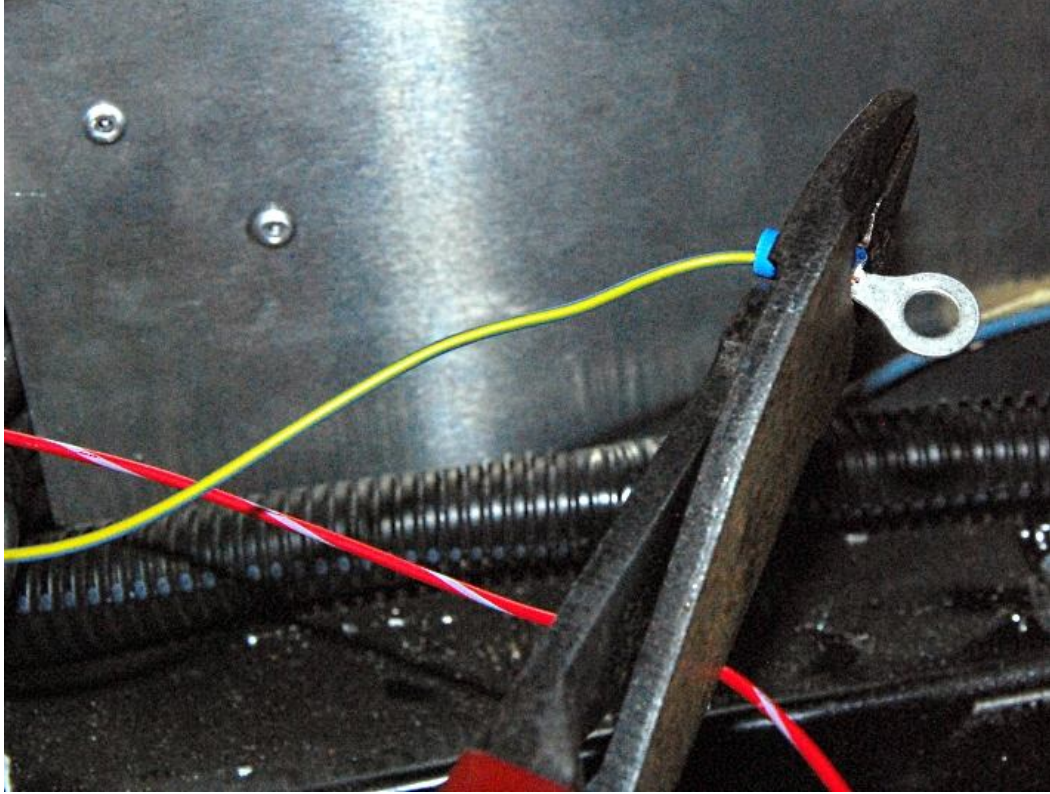

Cut the wire to length and crimp on a blue ring connector.

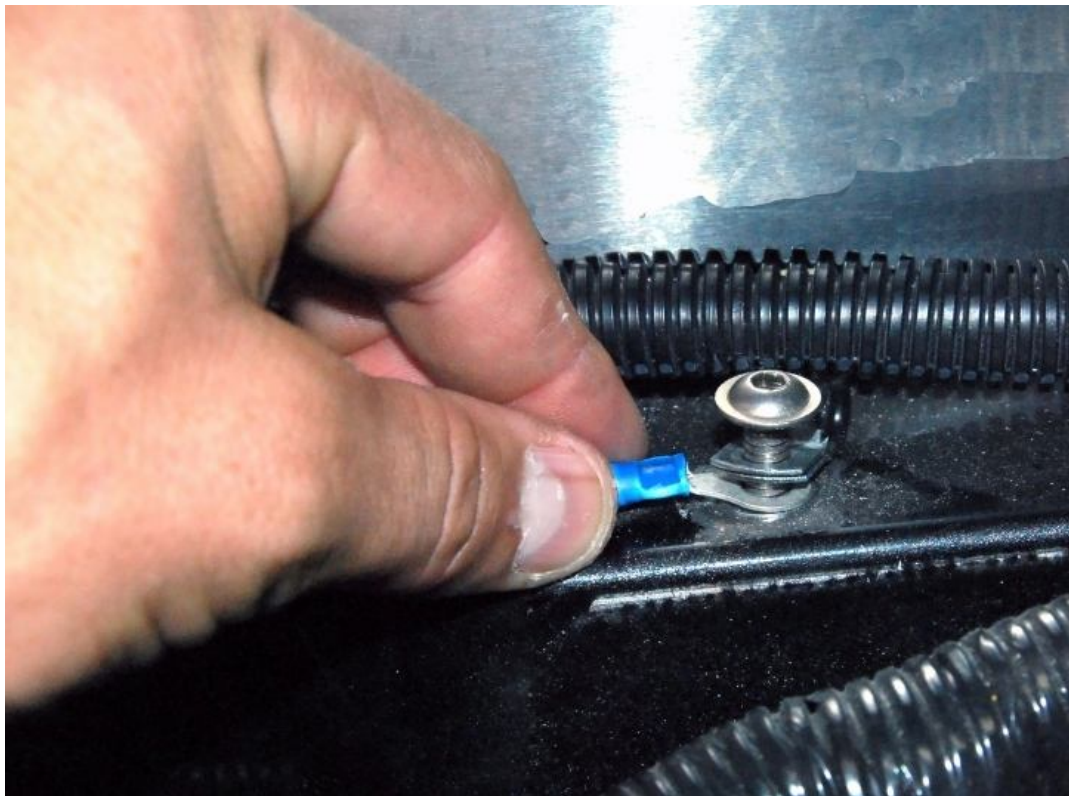

Attach the ring connector to ground.

Computer mounting

✂ Ratchet, 10mm deep socket, $\frac{5}{32}$ " Hex key, pliers

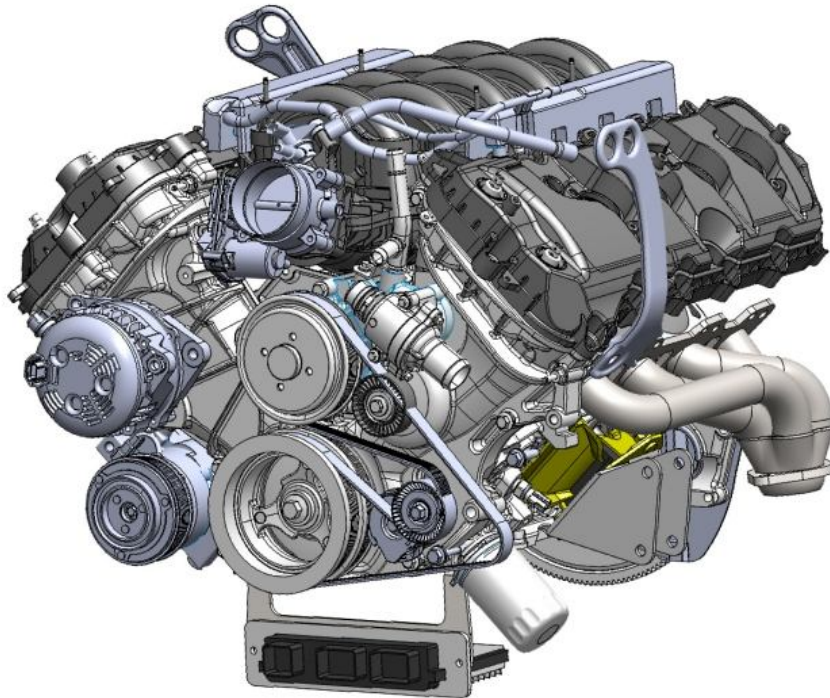

Place the computer mounting bracket onto the front oil pan stud on the right side of the engine as shown and the side mount stud on the left side of the engine.



Use a 10mm deep socket and 6mm locknuts to mount the bracket.



If using electric steering, hold the computer up to the front side of the bracket with the plastic side of the computer on top and check for clearance with the electric steering motor.



If necessary, use a pair of channel lock pliers to bend the computer bracket up slightly so there will be clearance for the computer.

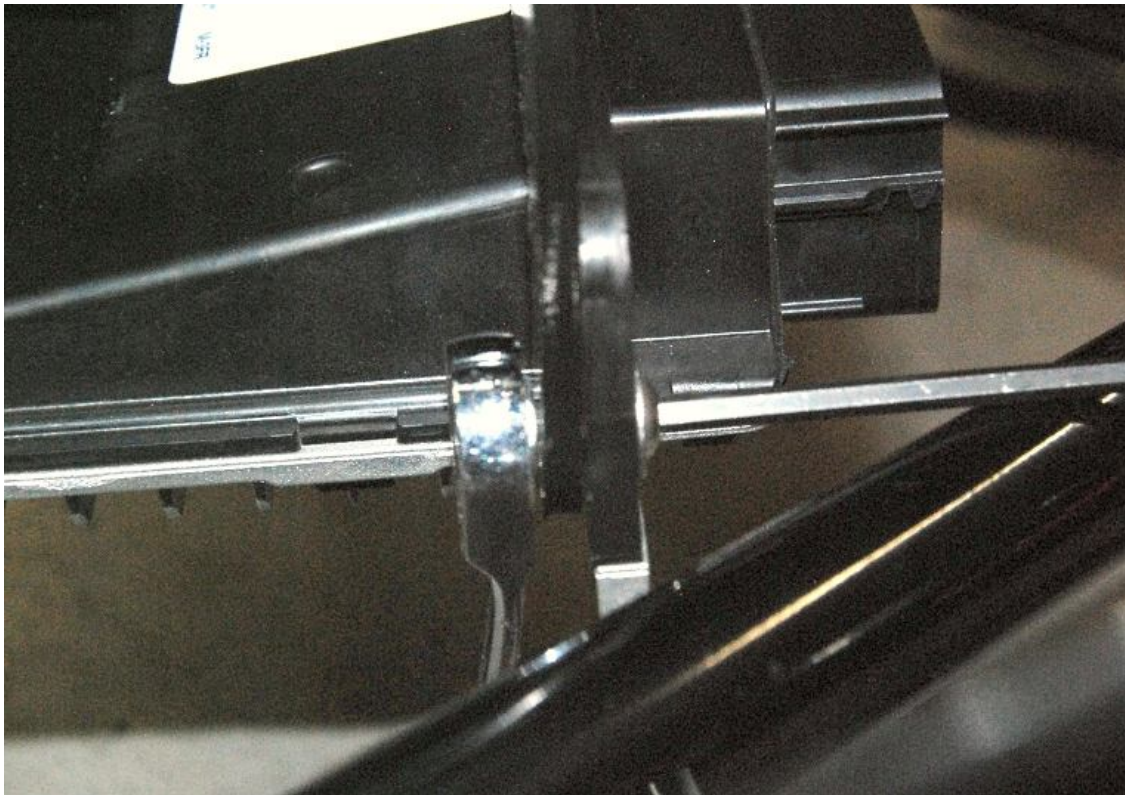

Test fit the computer again then attach the computer to the bracket.



Run the computer plugs on the right side of the oil pan.

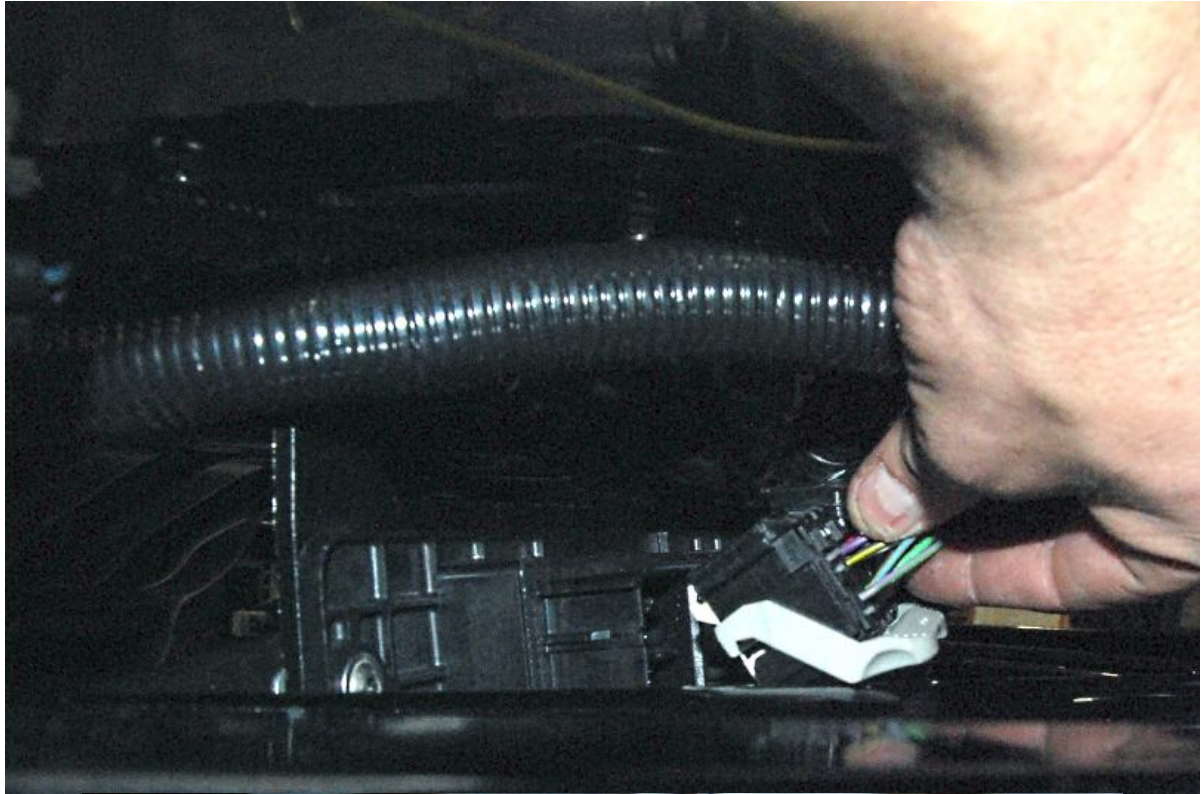

Plug the two engine harness plugs into the computer.

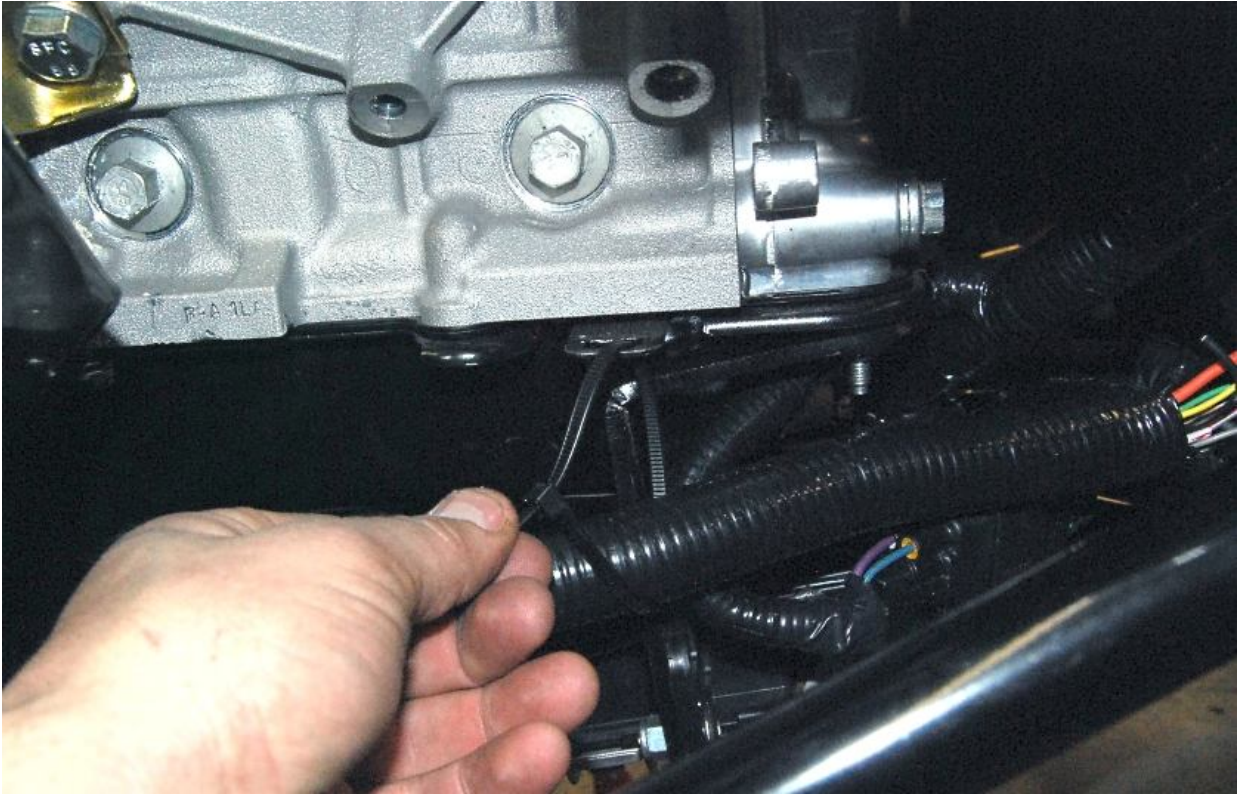

Pull the harness tight along the oil pan and zip tie the harness to the mounting eyes on the oil pan.

Starter Solenoid



The solenoid on the starter is the one being used to start the engine.

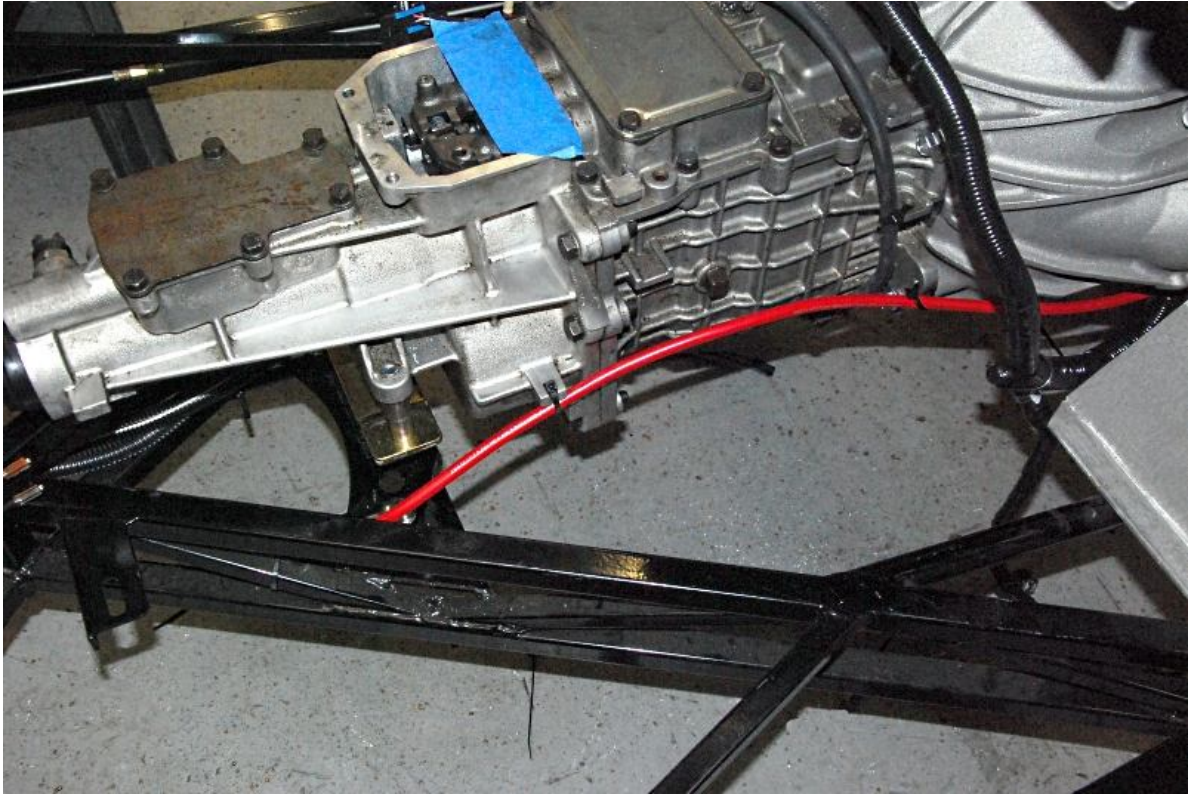

Run the battery cable to the starter solenoid along the transmission from the battery.

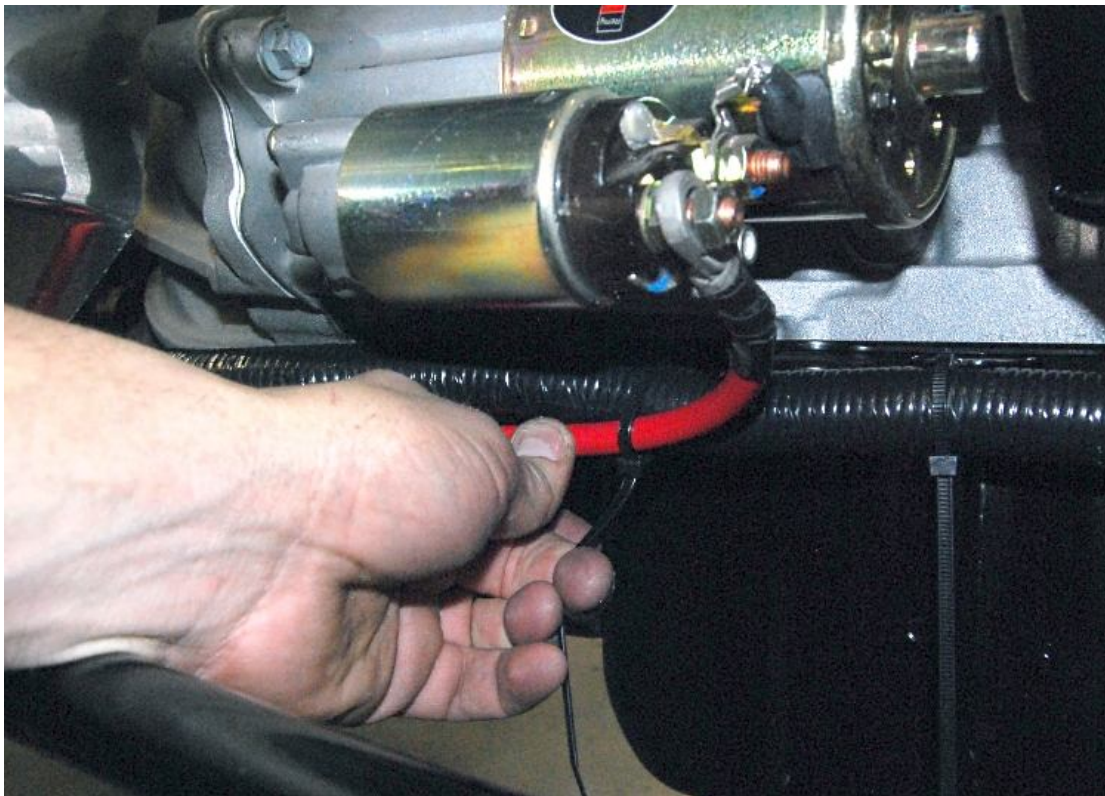

Attach the battery cable to the starter solenoid.



Make sure not to push the cable too far over or it may contact the starter post.



Attach the tan/green wire to the starting post on the solenoid.

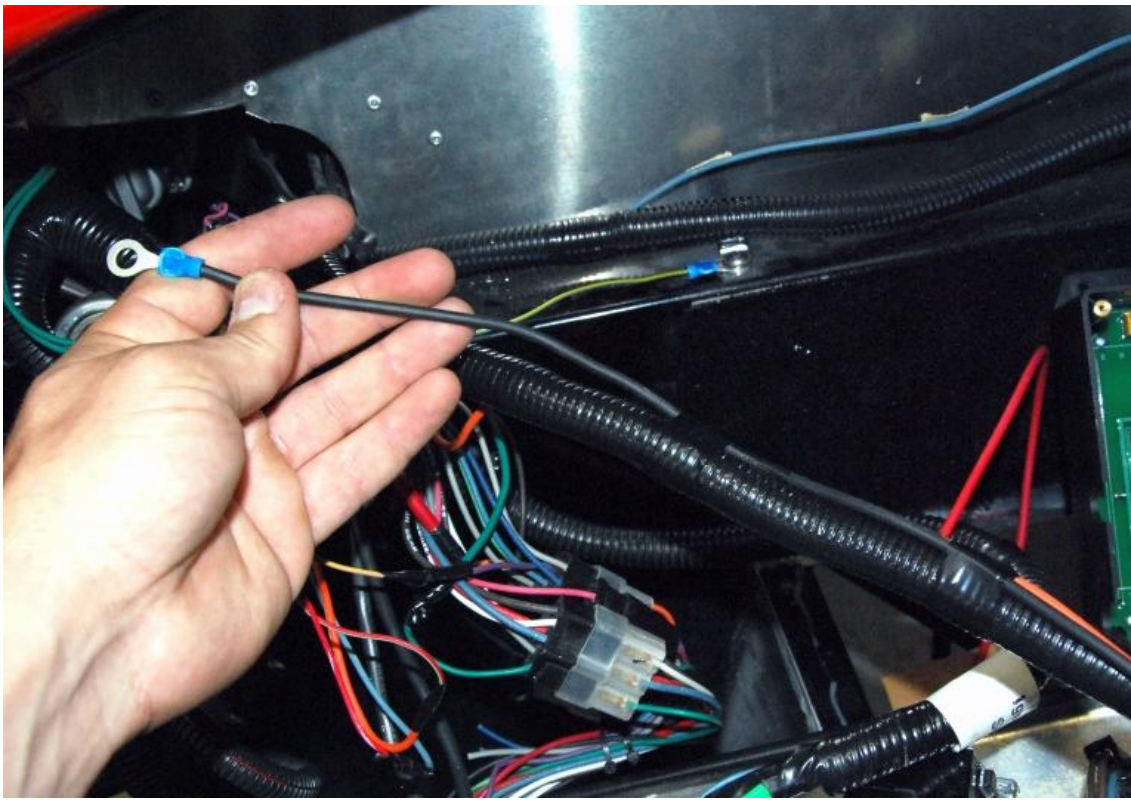

Run the ground wire that exits the harness with the tan/green starter wire over to your engine ground strap ground or some frame ground.

Crimp a ring connector to the ground wire.

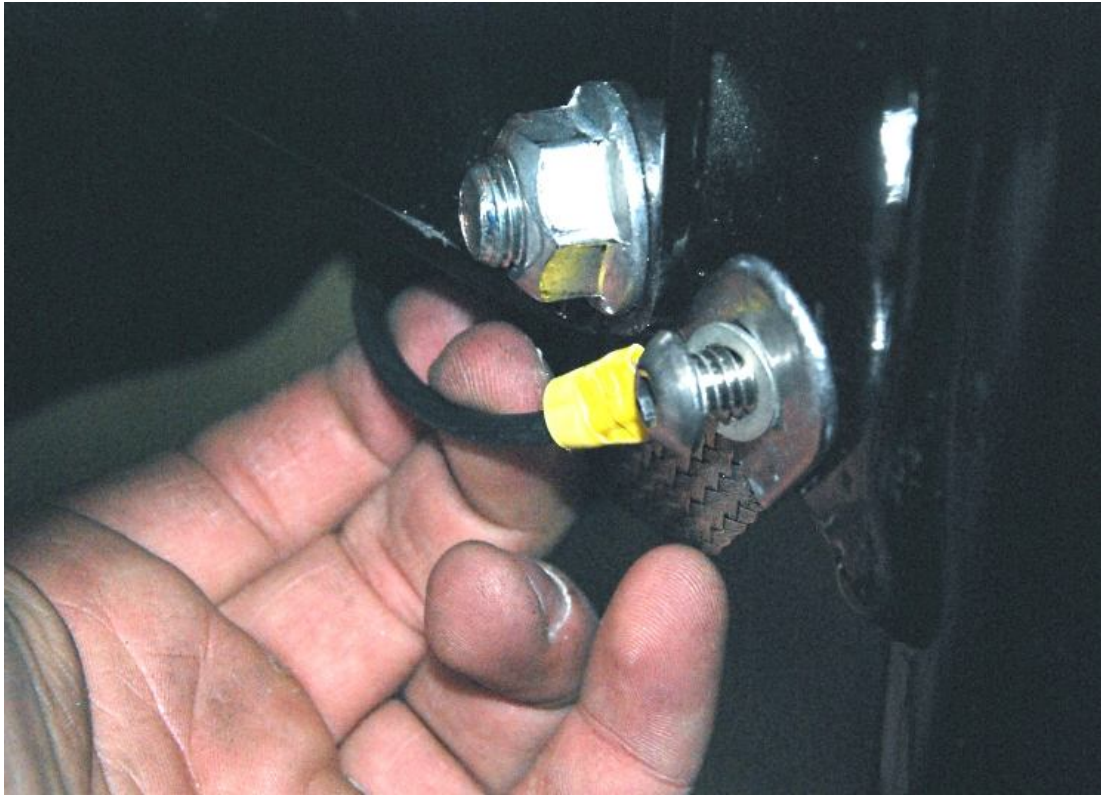

Attach the wire to ground.

Attach the battery cable, starter wire and ground wire to the oil pan with the wiring harness.

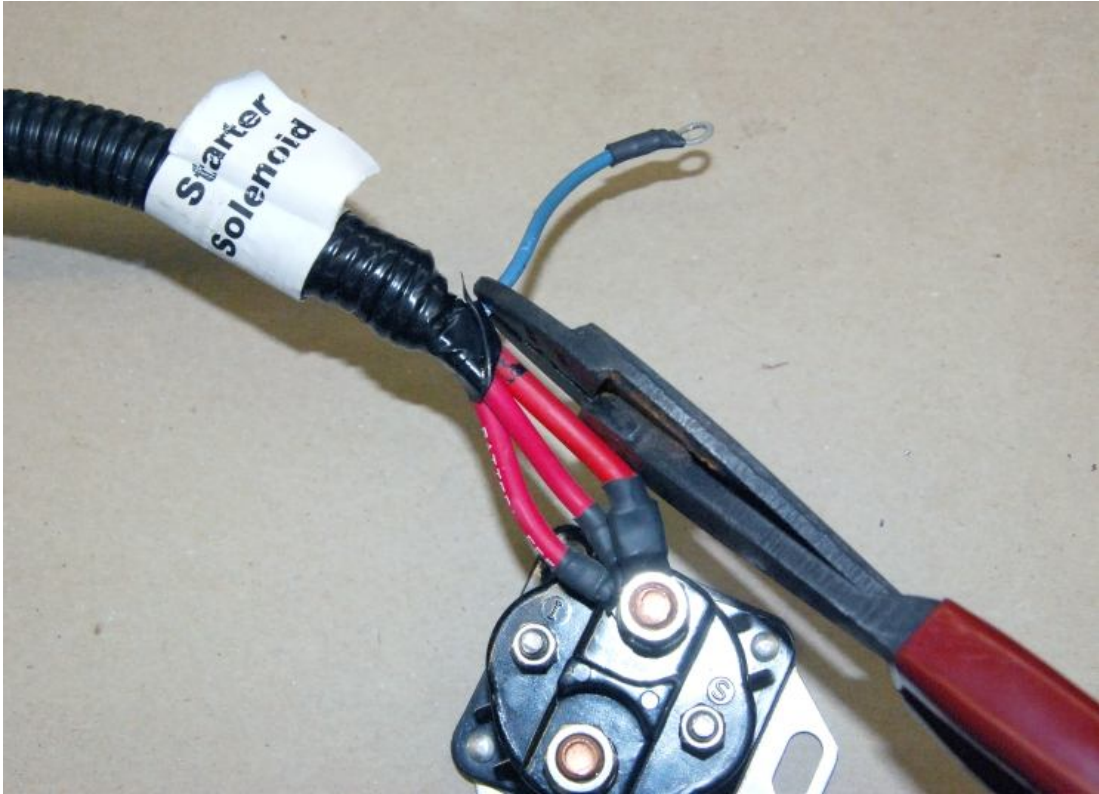

Cut the chassis harness blue starter solenoid wire back to the harness conduit.



Use electrical tape to cover the end of the blue wire.

Radiator Cooling Fan



It is best to let the engine control the radiator fan. If you do not want to do this, do not use the wires and remove the correct radiator fan fuse from the black box and skip this section.

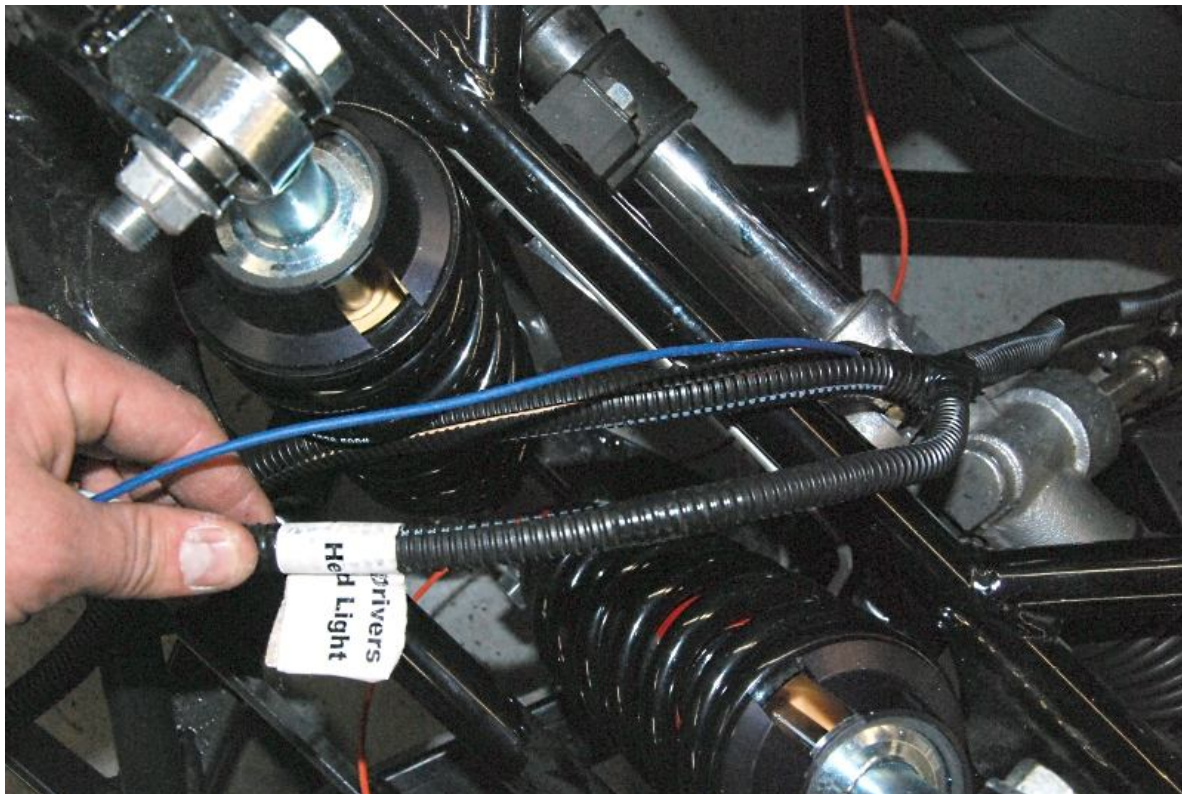

Pull the blue fan wire out of the chassis harness back to the steering bearing mount.



Cut the blue fan wire.

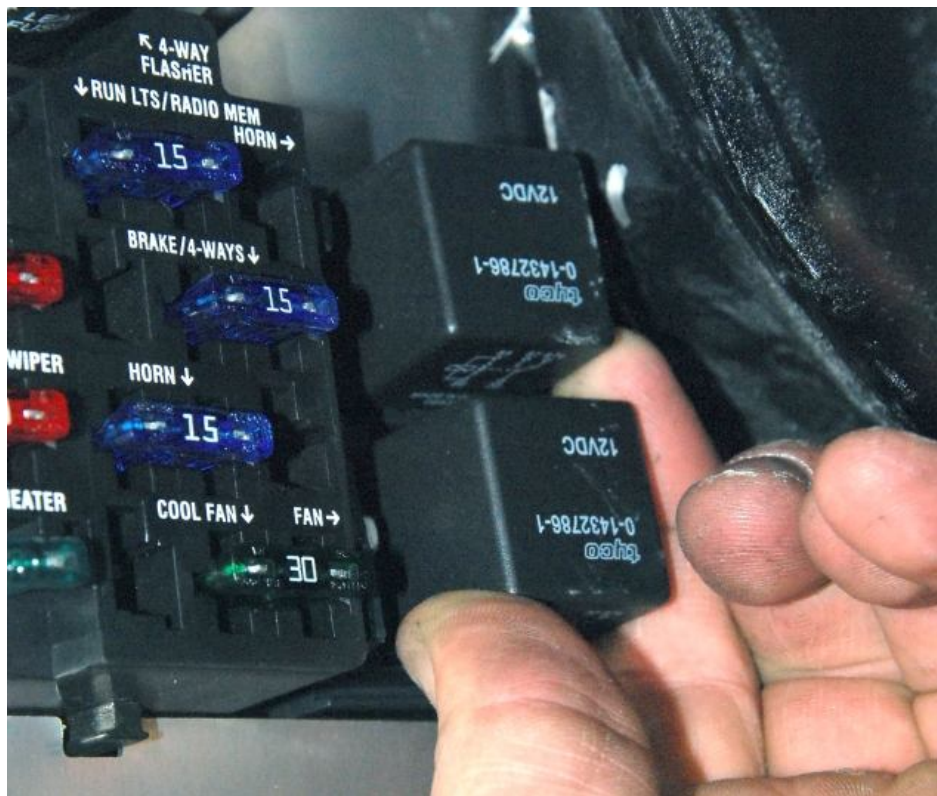

Remove the fan relay from the fuse panel.

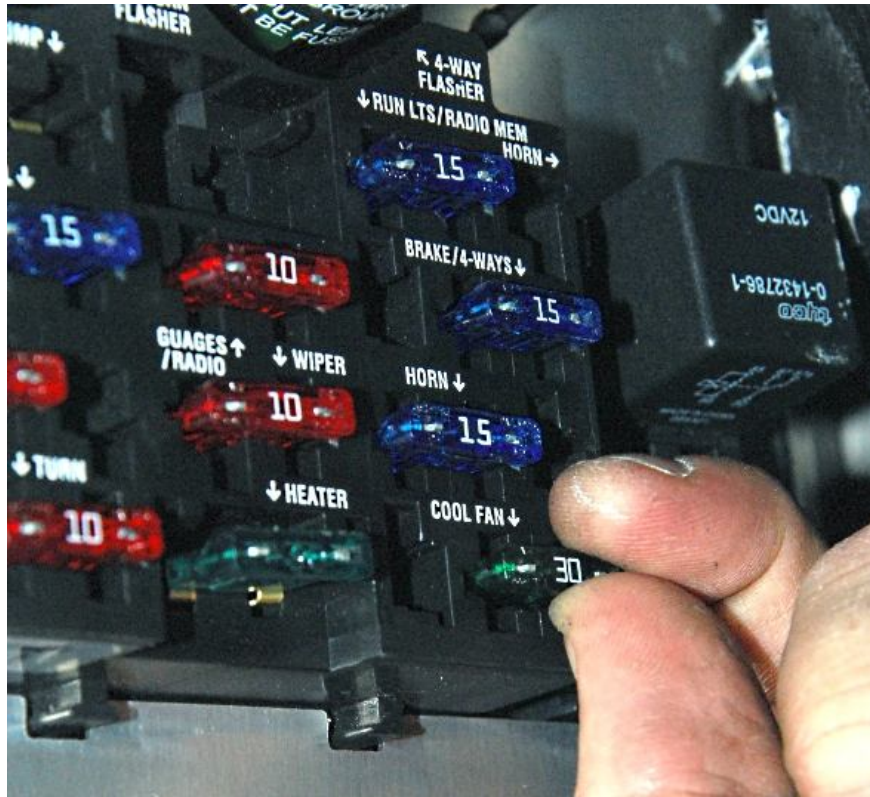

Remove the fan fuse.

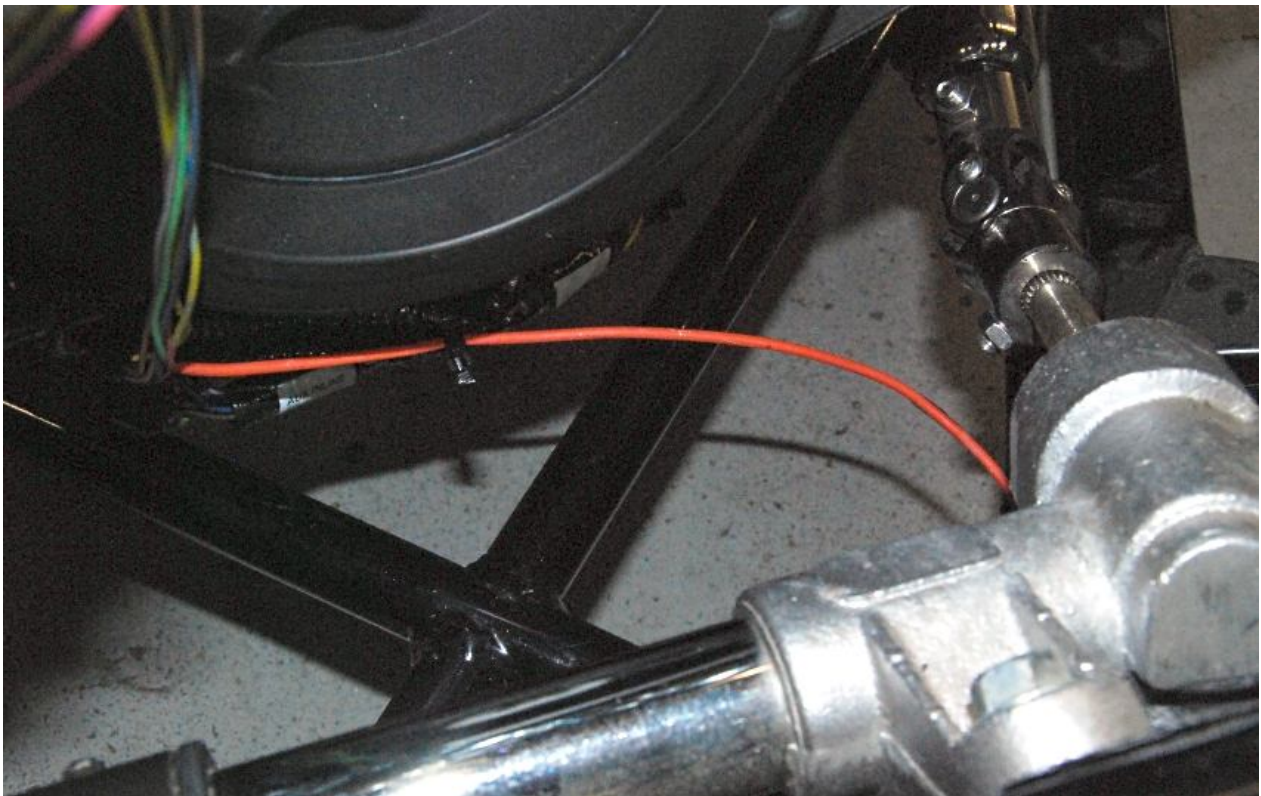

Run the orange and black Coyote harness fan wires over to the front chassis harness.

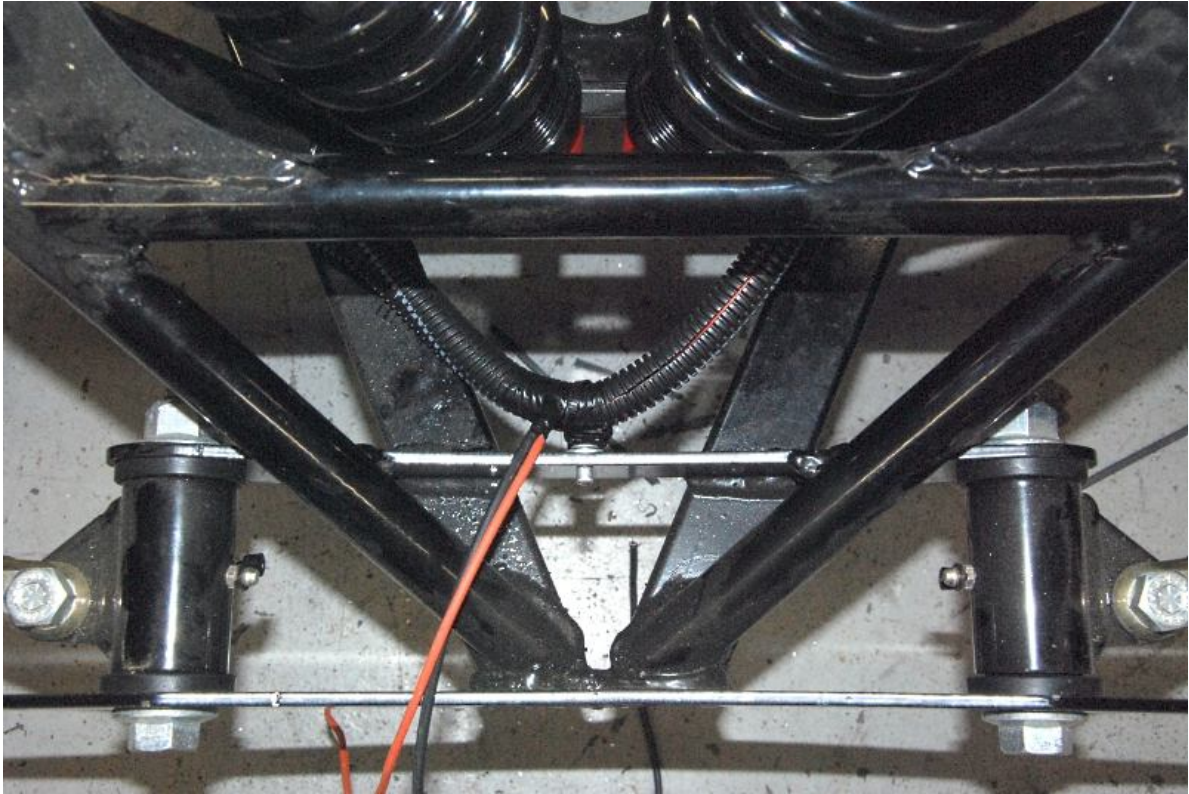

Run the fan wires forward to the front of the frame with the chassis harness.

Power/start

✂ Soldering iron, wire cutters/strippers, electrical tape

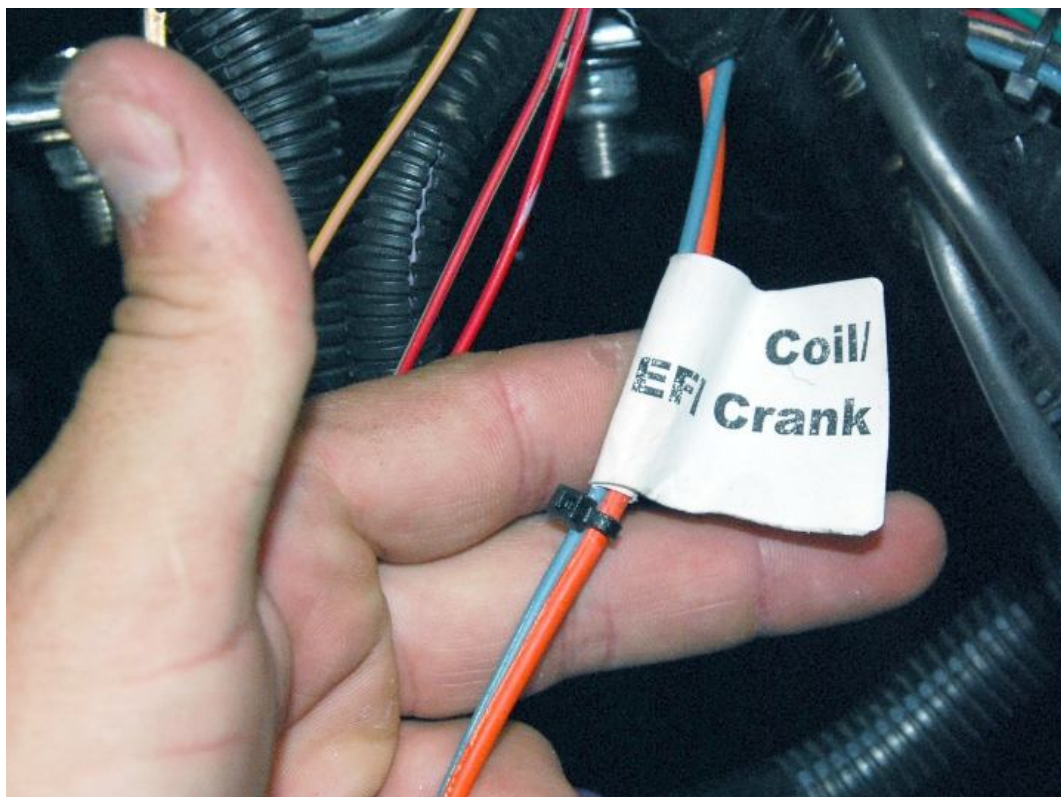

Locate the EFI/crank and coil wires in the chassis harness.

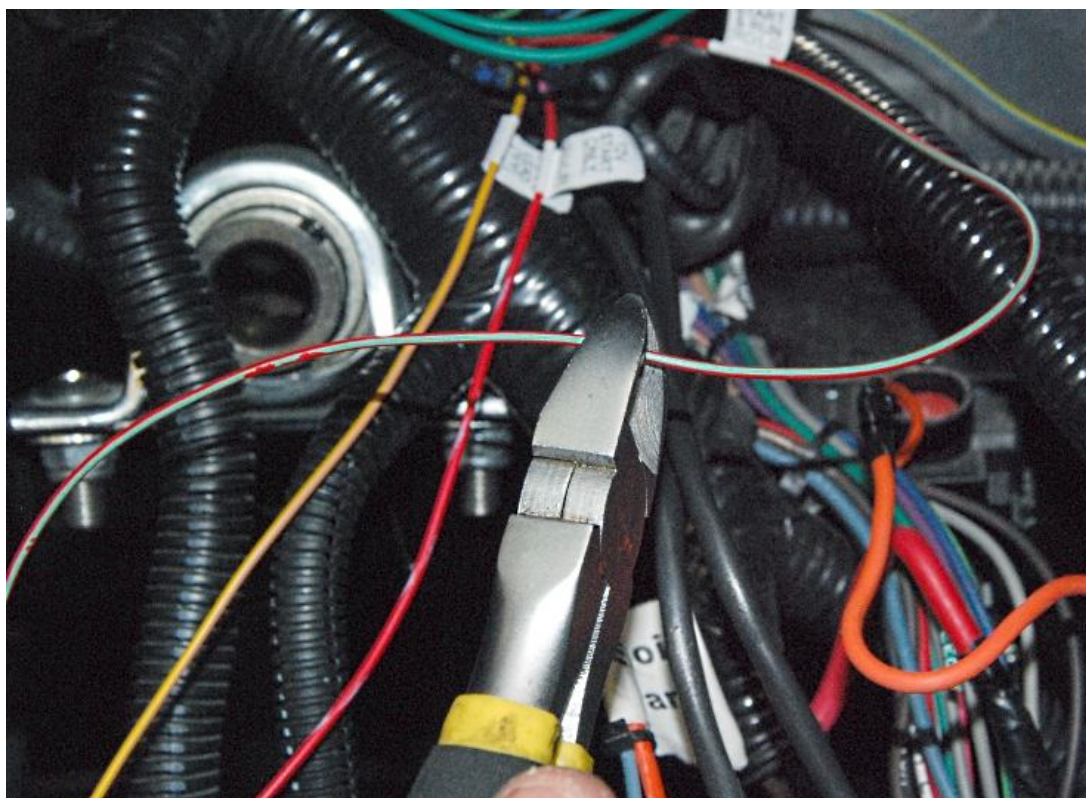

Route the Coyote 12v start/run wire (red/green) and 12v start (red/blue) wires to the chassis harness EFI wires and cut to length.

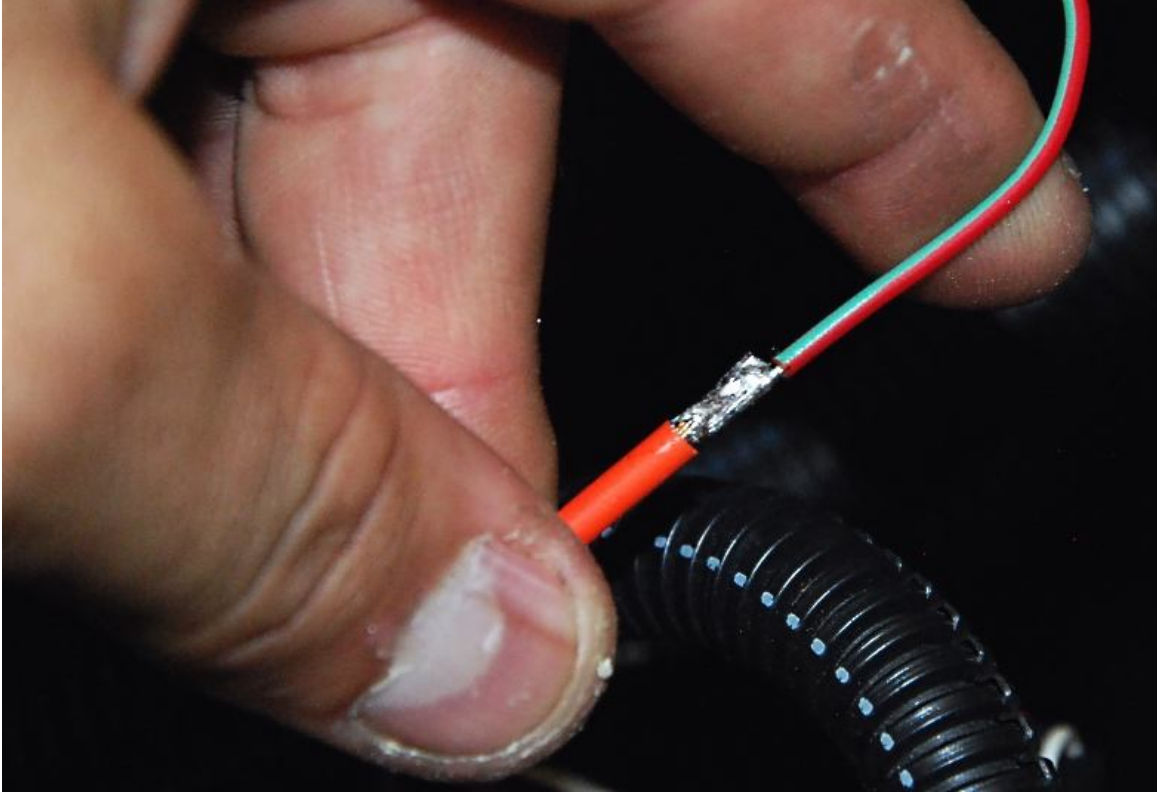

Connect the 12v start/run wire (red/green) wire to the orange coil wire.

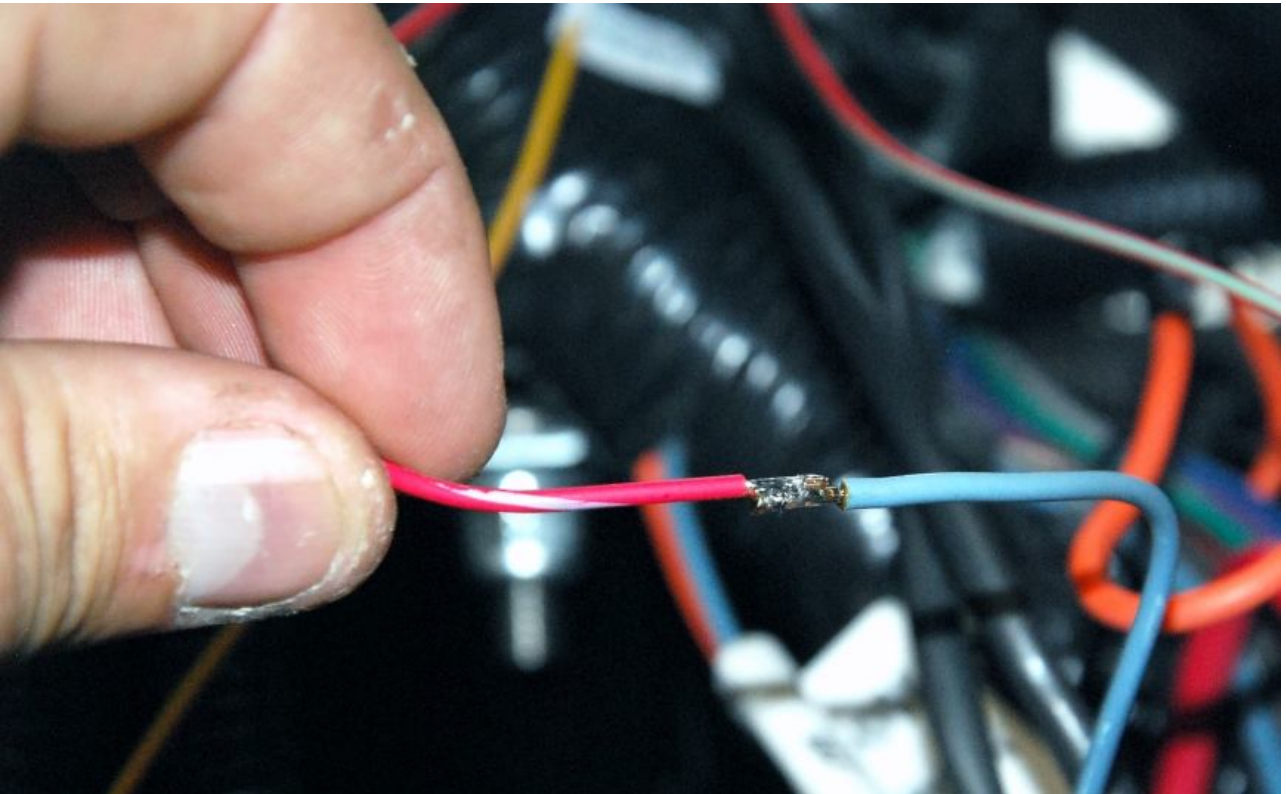

Connect the 12v start (red/blue) wire to the blue crank wire.

Gauges

Tach

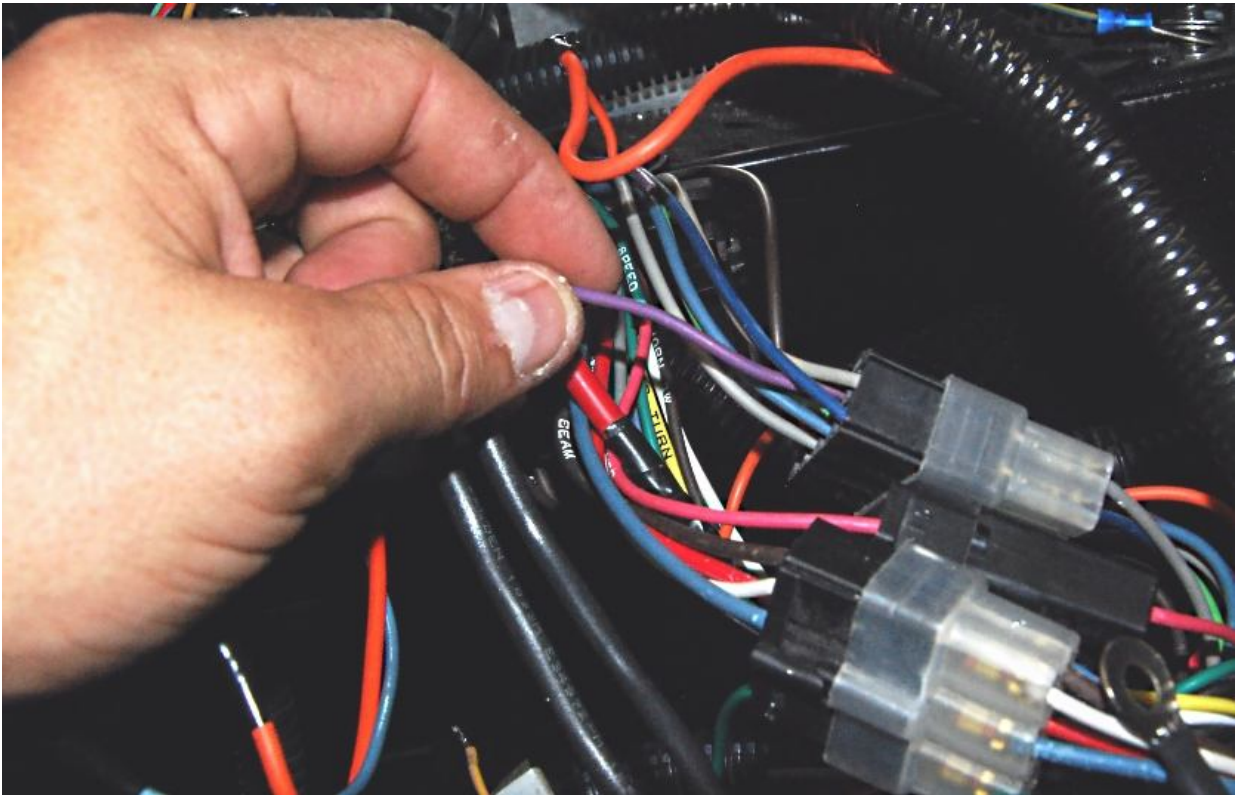

Find the purple tach wire in the sending unit plug and cut it so the engine harness can get connected to the purple wire.

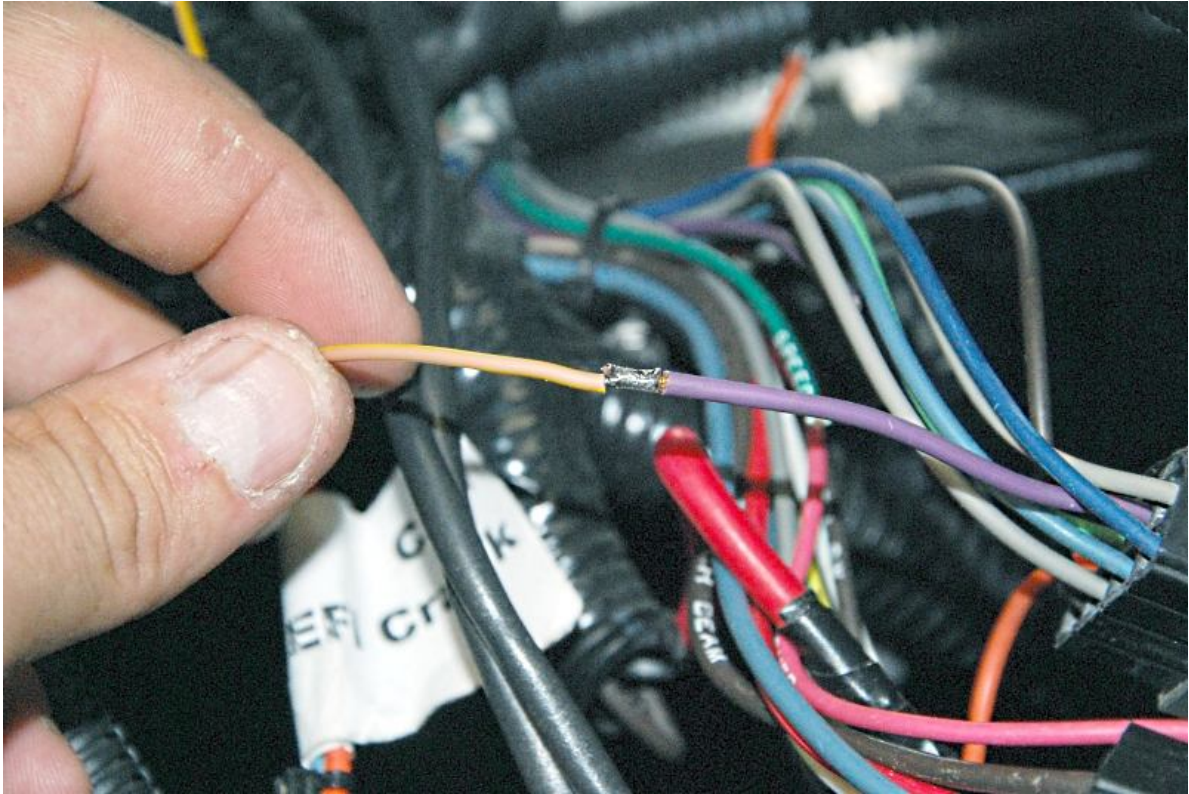

Run the engine harness tan/yellow tach wire over to the purple wire and solder them together.

Water Temp Sender

✂ Wire cutter, wire crimper, $\frac{3}{8}$ " wrench

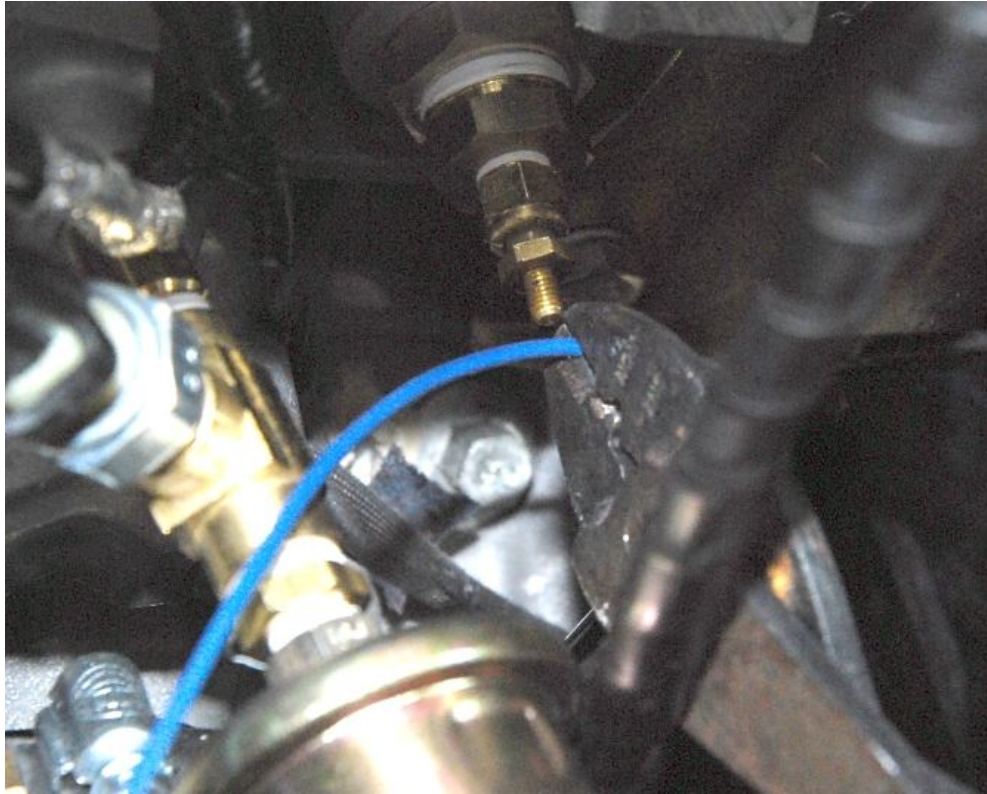

Run the blue water temp chassis harness wire to the sending unit and cut to length.

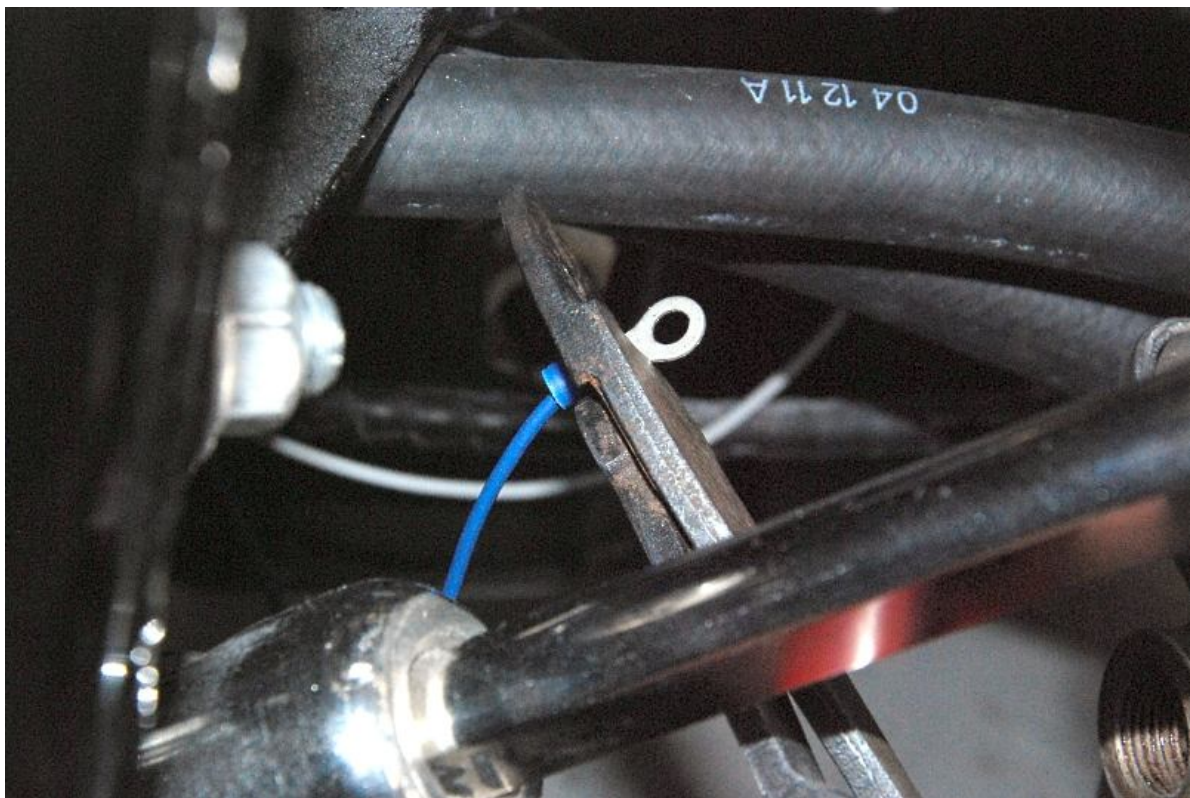

Crimp a ring terminal to the sending unit wire.



Attach the ring terminal to the water temp sending unit.

Oil Temp sender

✂ $\frac{3}{8}$ " , $\frac{11}{16}$ " wrenches, Wire cutter, wire crimper



Push the Engine/computer harness plug onto the stock sending unit.

Run the chassis harness gray oil pressure wire to sending unit and cut to length.
Crimp on a blue ring terminal connector.



Rotate the sending unit so the computer sending unit is facing the rear of the engine.

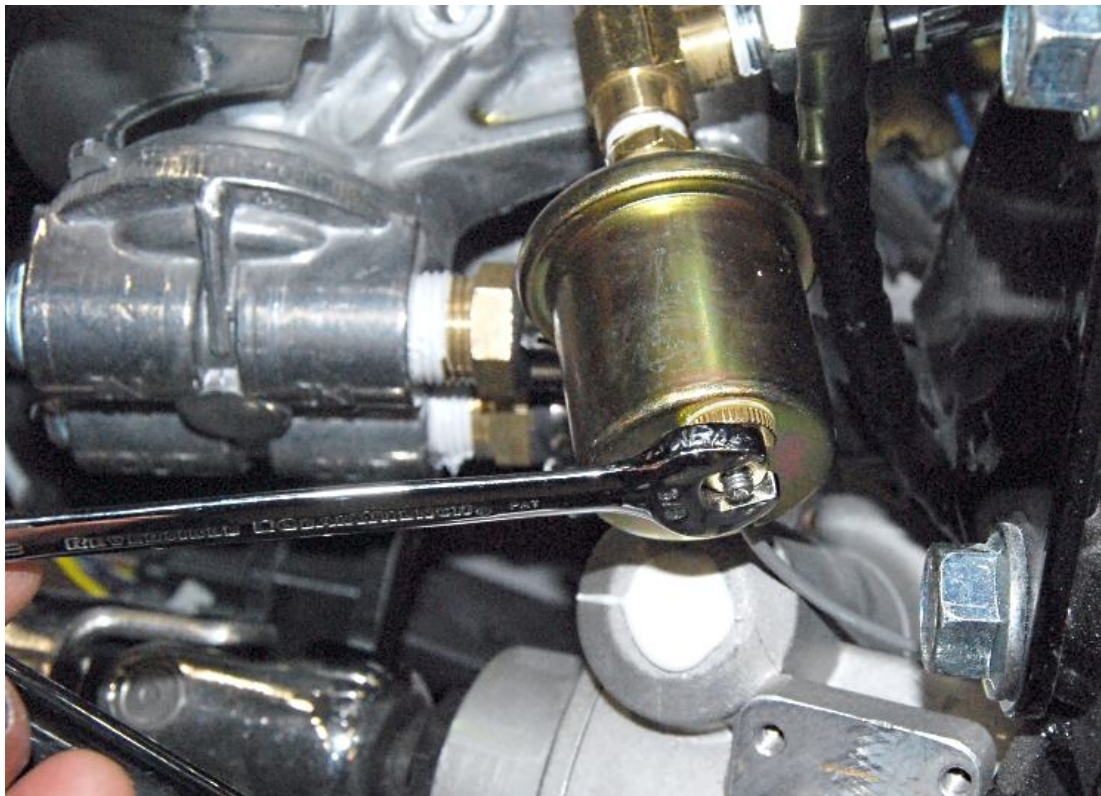

Attach the sending unit wire ring terminal to the sending unit.

O₂ Harness

✂ Soldering iron, wire cutters/strippers, electrical tape

Locate the right side O₂ wires in the Coyote harness near the bellhousing.



Zip tie the harness forward to the harness going to the computer.

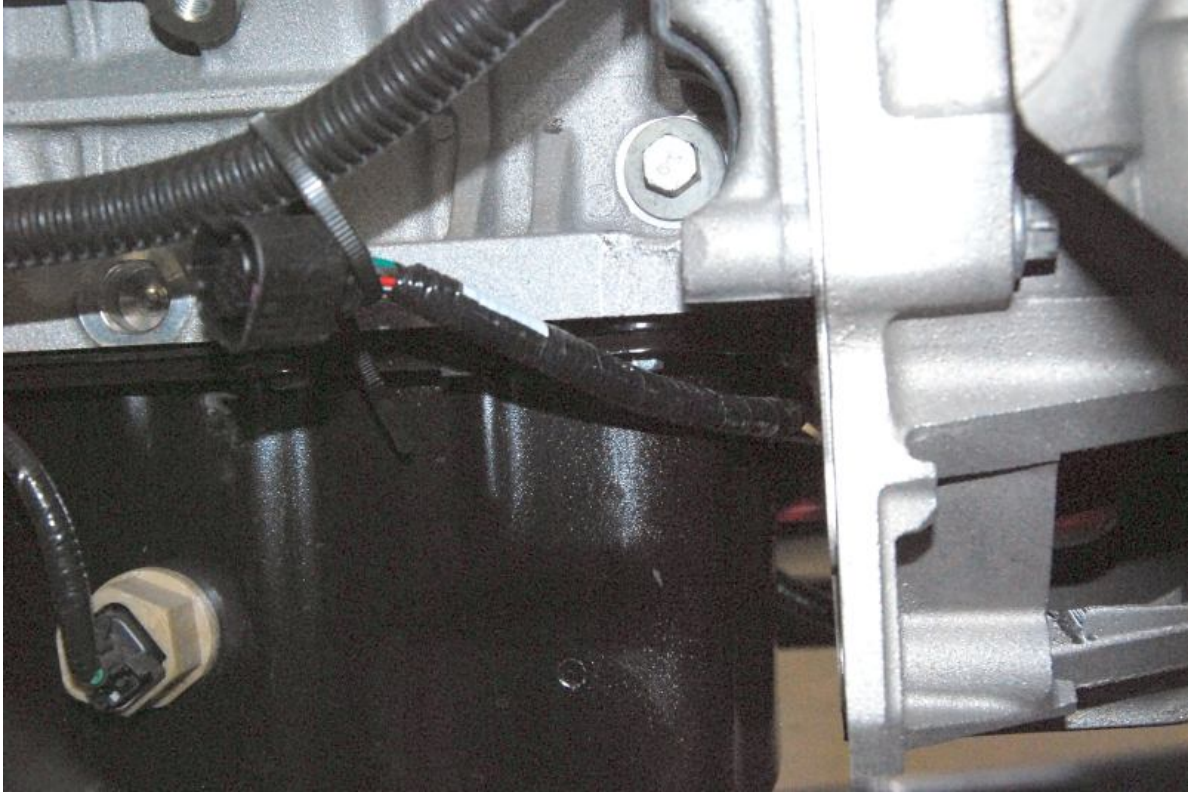

Run the left side O₂ wires between the oil pan and bellhousing over to the left side of the engine.

Intercooler wire



Cut the white/red Intercooler pump wire as far back in the harness as you can. It is not needed or used.

Power Distribution

- ✂ Wire cutters/strippers, electrical tape, wire crimpers.
- 👉 We used an extra starter solenoid for power distribution in these instructions. A distribution post is provided in the Coyote kit.
- 👉 The solenoid on the starter is the one being used to start the engine.

Locate and attach the power distribution post to the 2"x 2" tube.



Shorten and attach the red wire from the black box to the power distribution post using one of the yellow ring connectors.

Attach a ring connector to the 10 ga red wire.

Attach the 10 ga wire ring connector to the post.

Run the 10 ga wire to the battery side of the starter solenoid on the engine.

Cut the wire to length and attach another yellow ring connector.



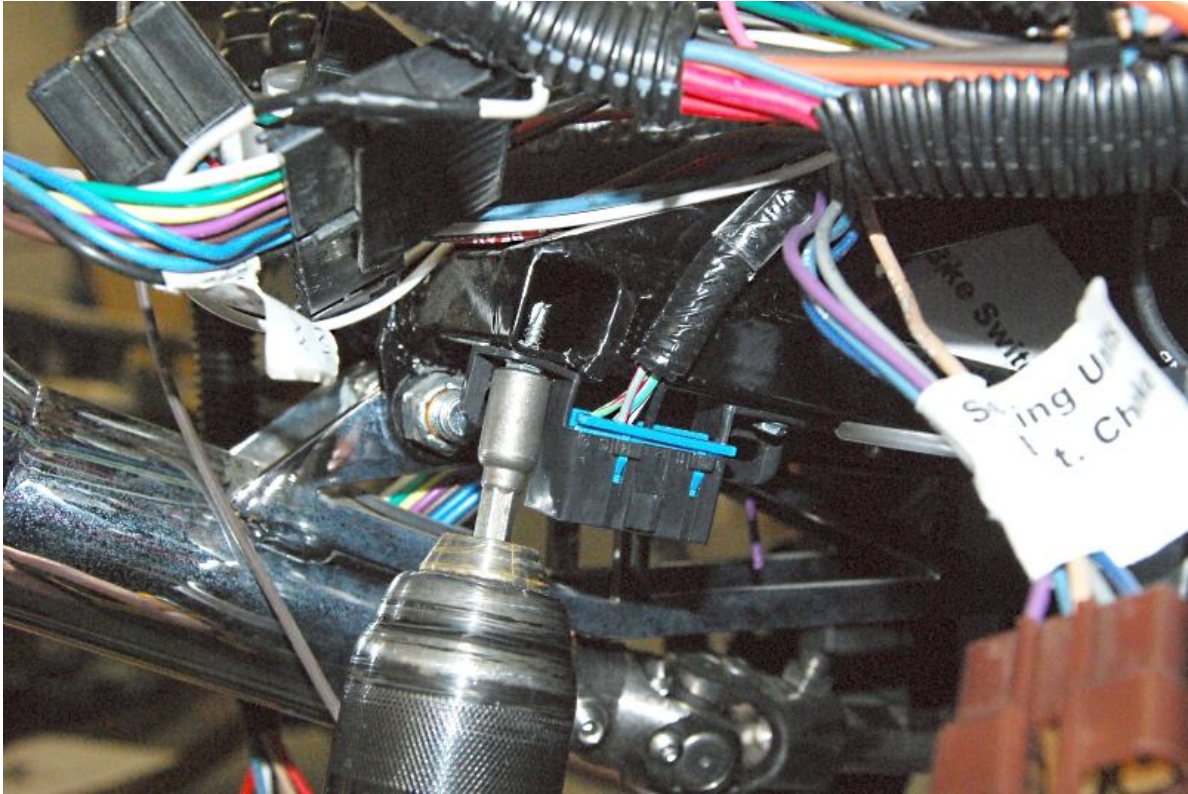

OBD 2 Port

Locate the OBD 2 port on the 3/4" tube to the right of the pedal box.



Use some of the aluminum panel #6 screws to attach the OBD 2 plug to the frame.

Alternator

-  10mm, 13mm, (2) 17mm wrenches, 10mm socket, ratchet, wire stripper, wire crimper
-  Alternator, Alternator drive kit
-  The stock Alternator is designed to run counter clockwise and the frame goes through the stock location so it can not be used. With the internal fan curve direction of the stock Alternator, there is a possibility that the Alternator could overheat when run in the opposite direction.
-  The Honda alternator runs clockwise and when run in the orientation we use it is run the correct way.

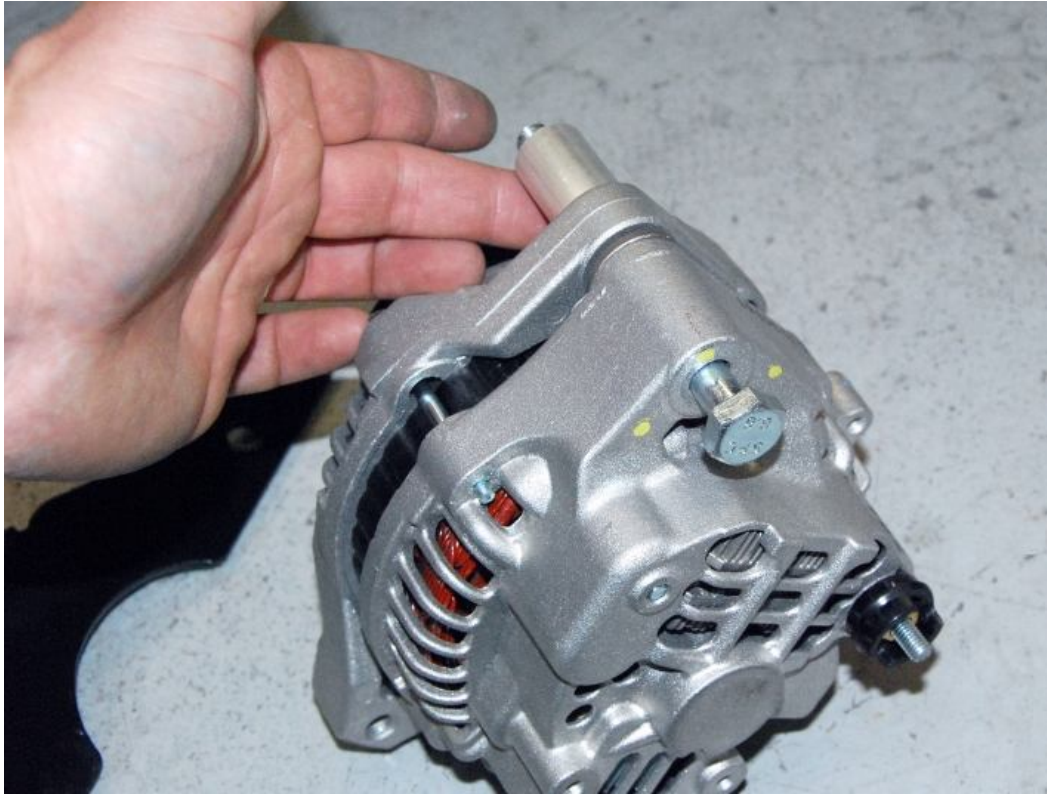

Put the large long bolt through the alternator and place the spacer on the bolt.

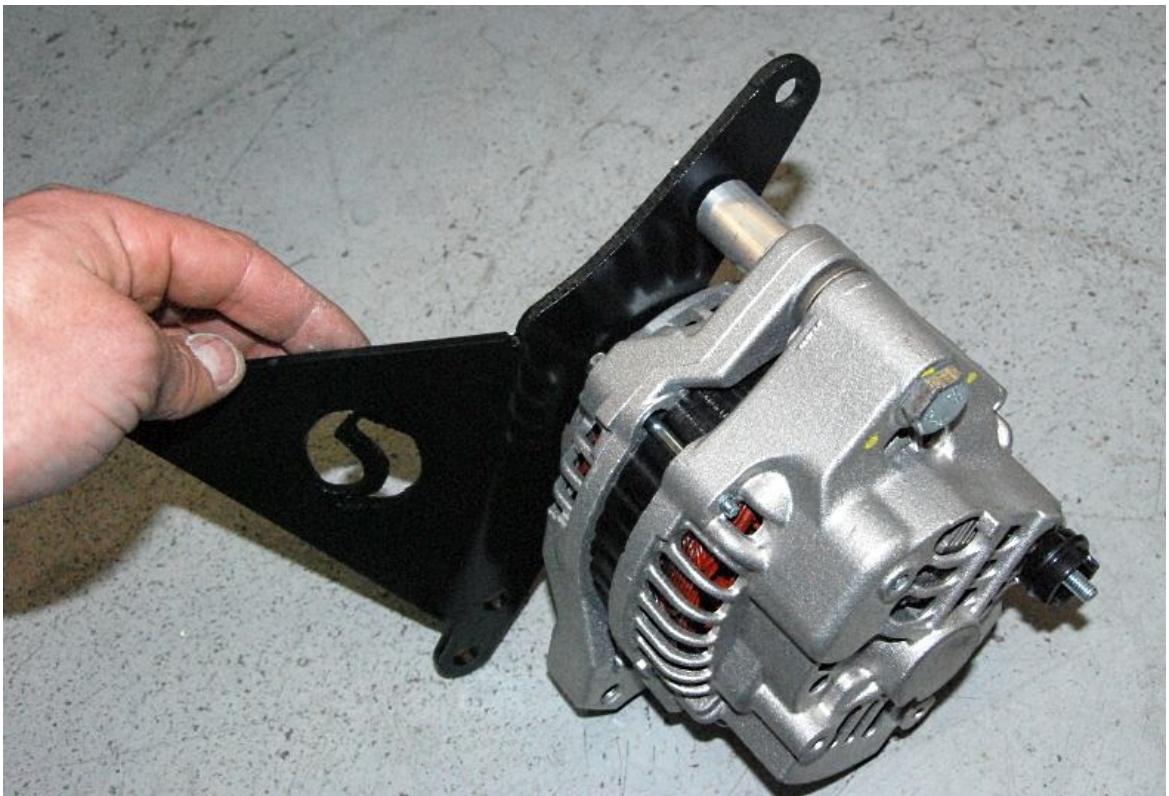

Attach the alternator to the mounting bracket leaving the nut so that the alternator can rotate.

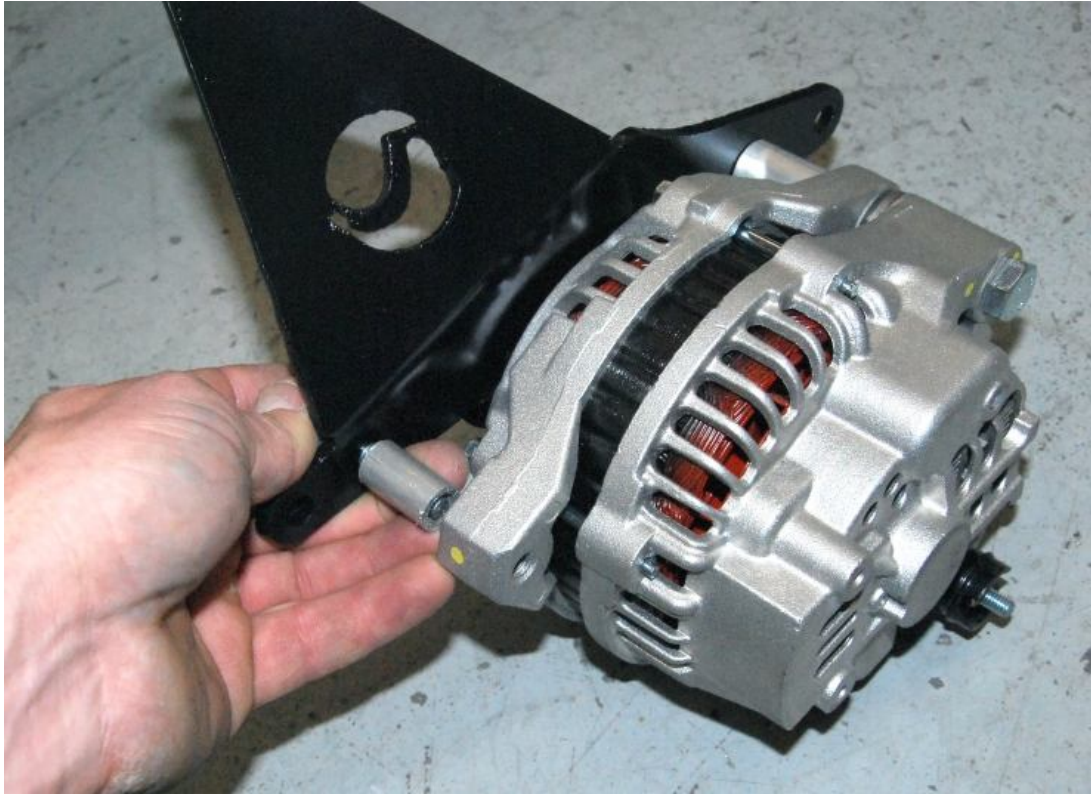

Pass the short bolt through the other bracket mounting hole and place the small ID spacer on the bolt.

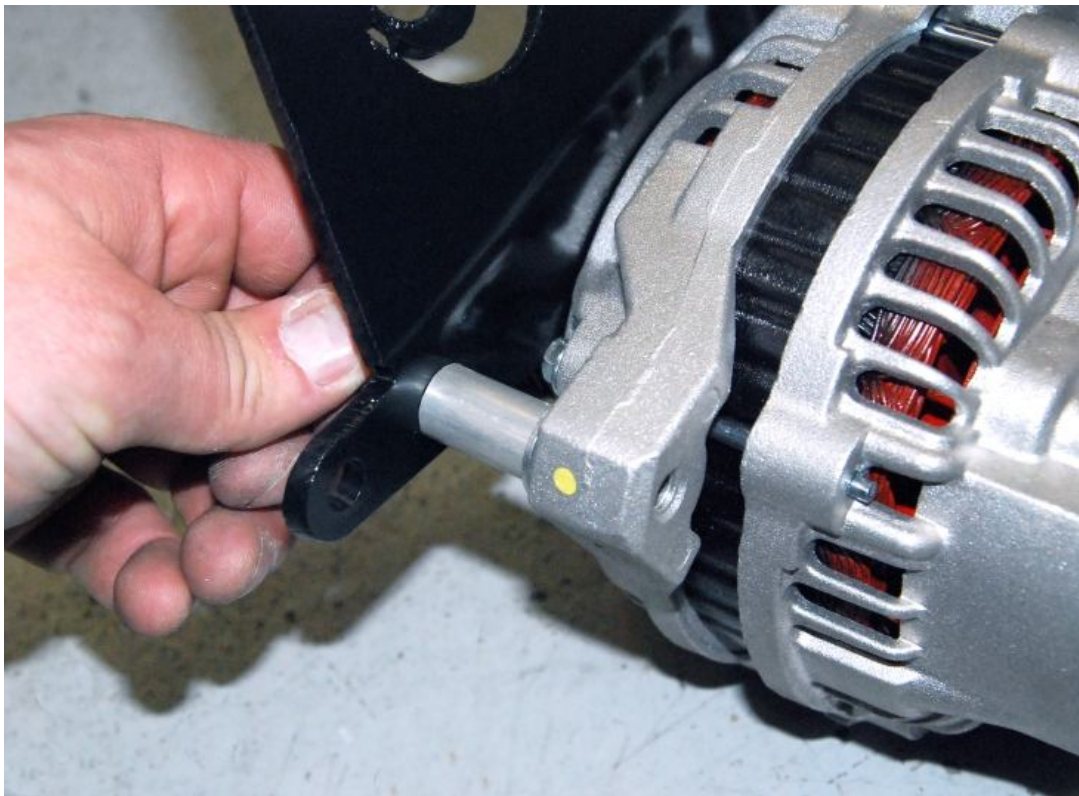

Thread the bolt into the Alternator.

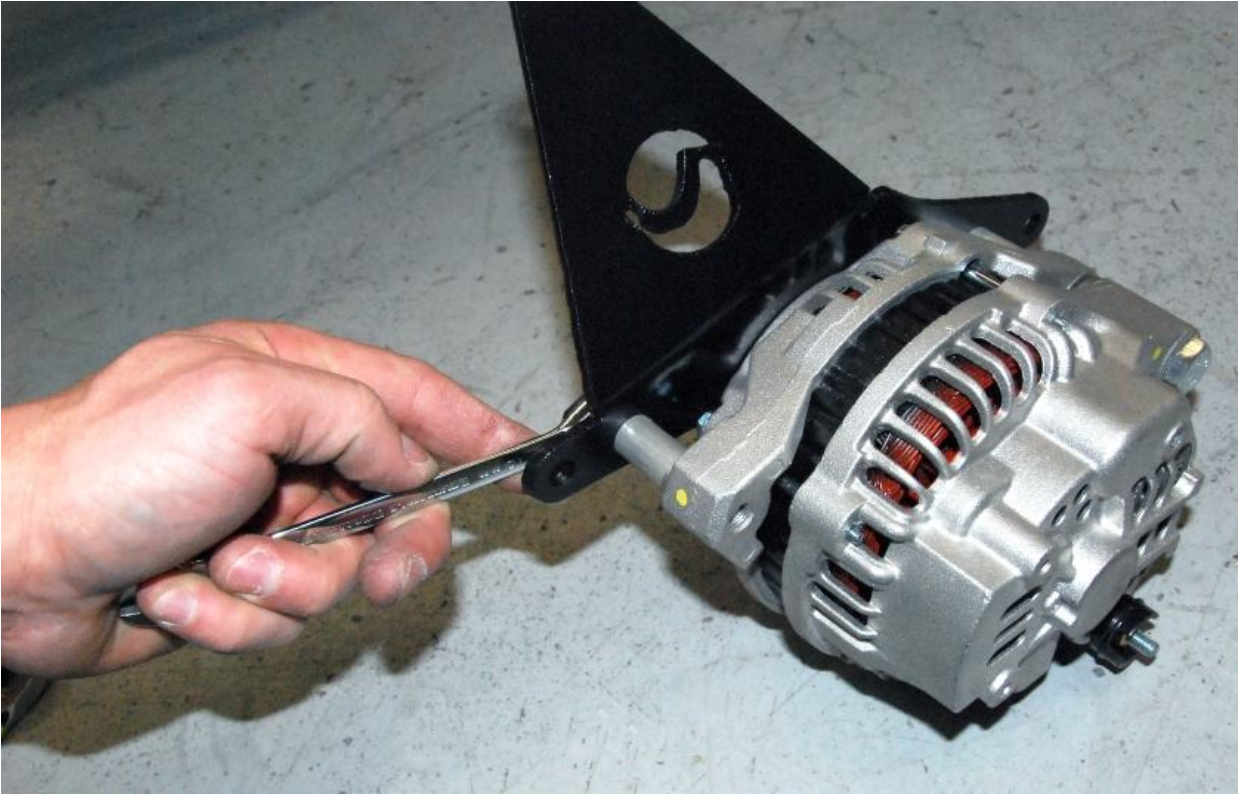

Tighten the alternator mounting bolts.



Run the bracket mounting bolts through the bracket and put the spacers on the bolts.

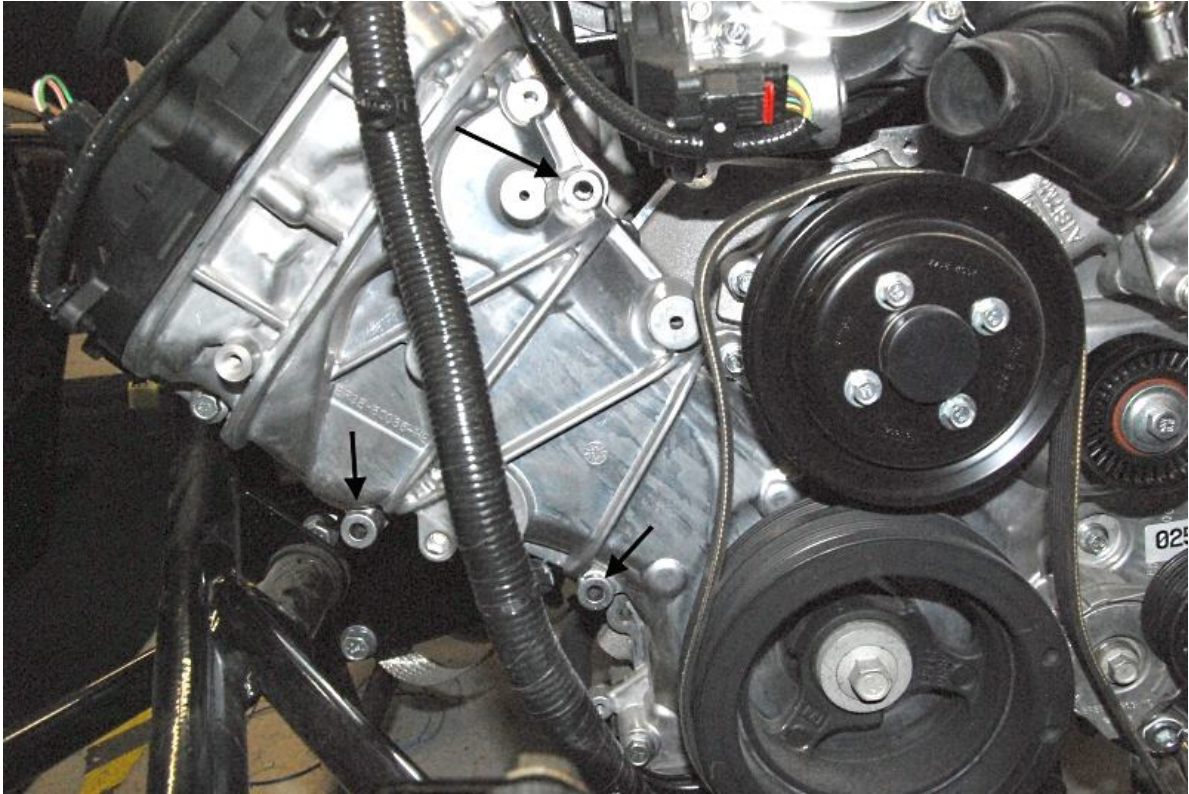

Remove the timing cover screws at the points shown in the picture above.



Attach the mounting bracket to the engine keeping the engine control harness behind the bracket.

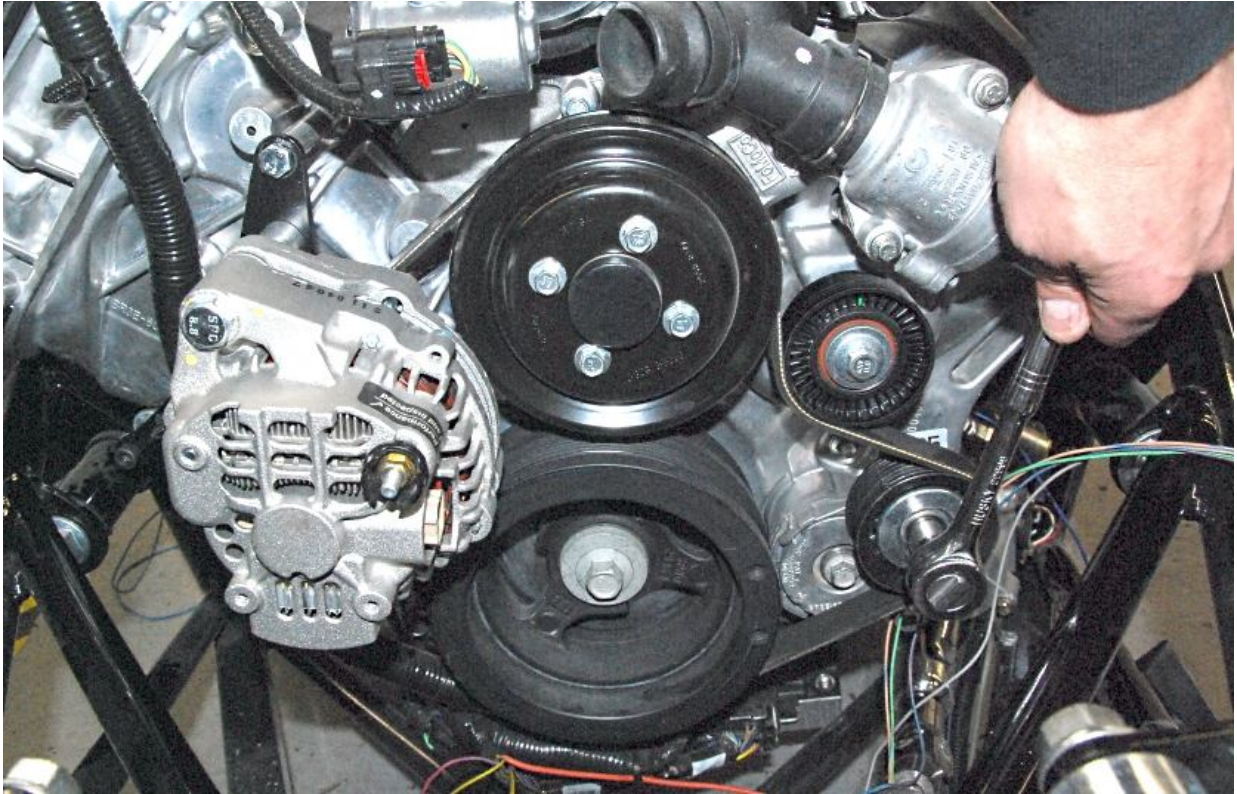

Attach the belt tensioner to the timing chain cover and tighten to 18 lbft (25Nm) then route the belt as shown.

Wiring



Run the red chassis harness alternator wire under the firewall up to the right side of the engine.



Run the alternator wire to the front of the engine next to the engine harness.

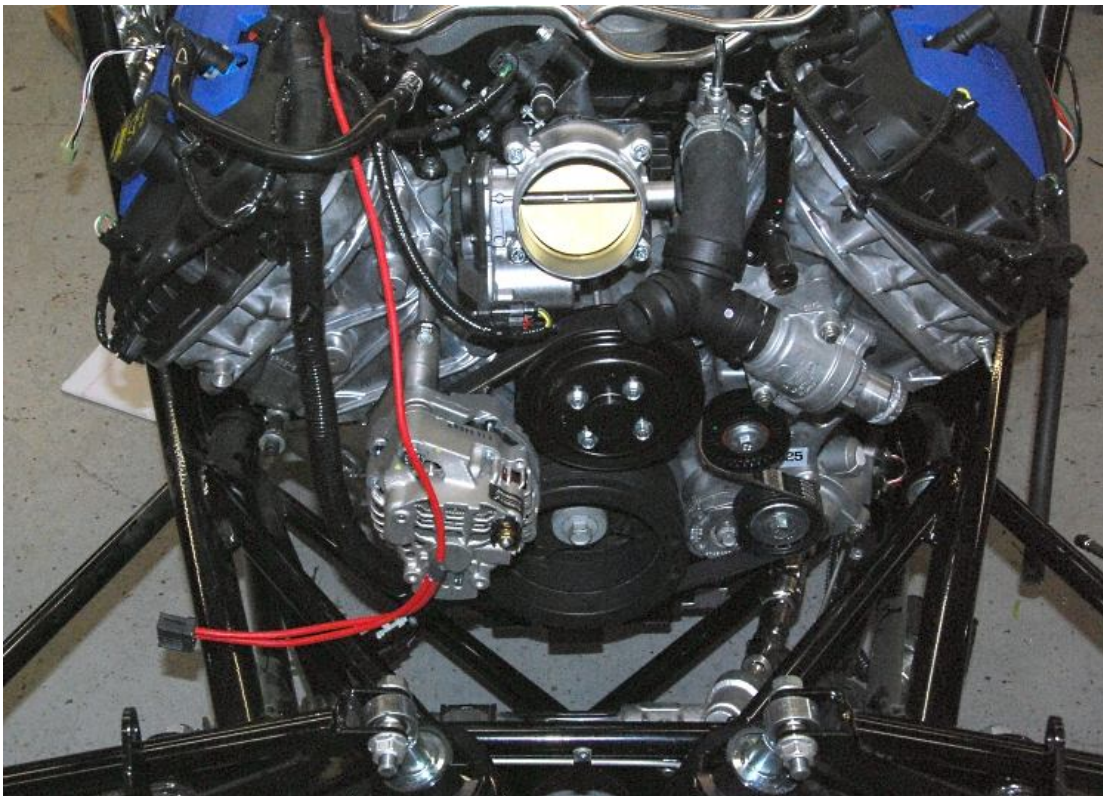

Run the alternator wire down to the alternator output post.

Cut the wire to length and attach a yellow ring terminal connector.

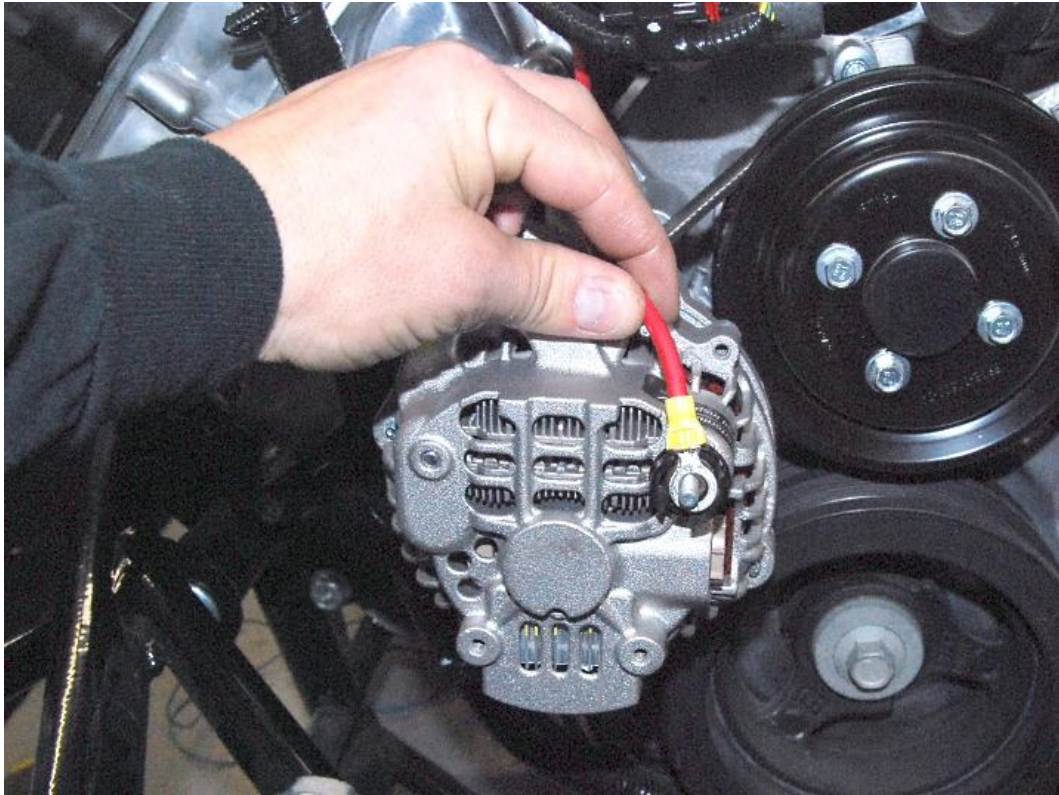

Put the ring terminal on the alternator output post.

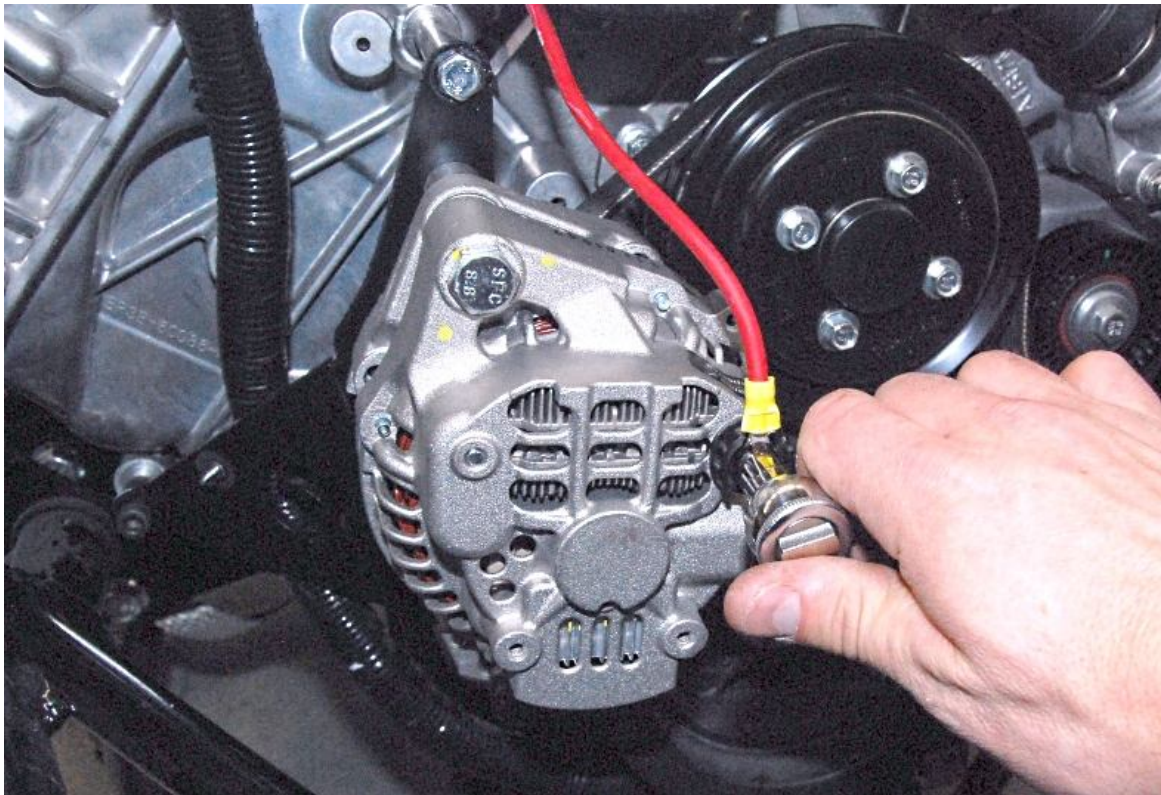

Tighten the locknut on the output post so that the nut is snug. Do not over-tighten or the post might break.



If a dash charge indicator light is desired, run a wire from the “Lamp” connector back to a dash light that is grounded on the other side of the light.

Locate the Coyote harness yellow alternator wire (VBAT Monitor) and run it to the Alternator plug. Cut the wire to length.

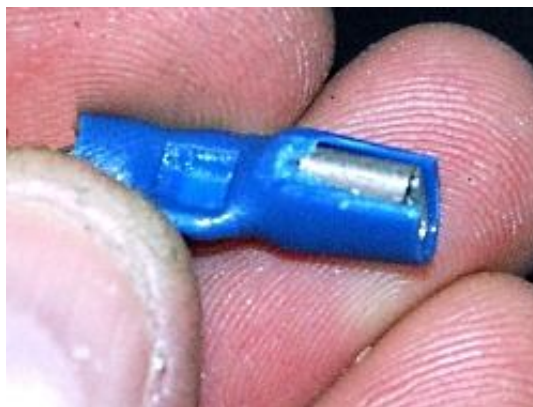

Test fit the small connector in the Alternator. If necessary, cut off part of the blue covering so that the connector will fit.



Crimp the small blue connector onto the yellow wire.

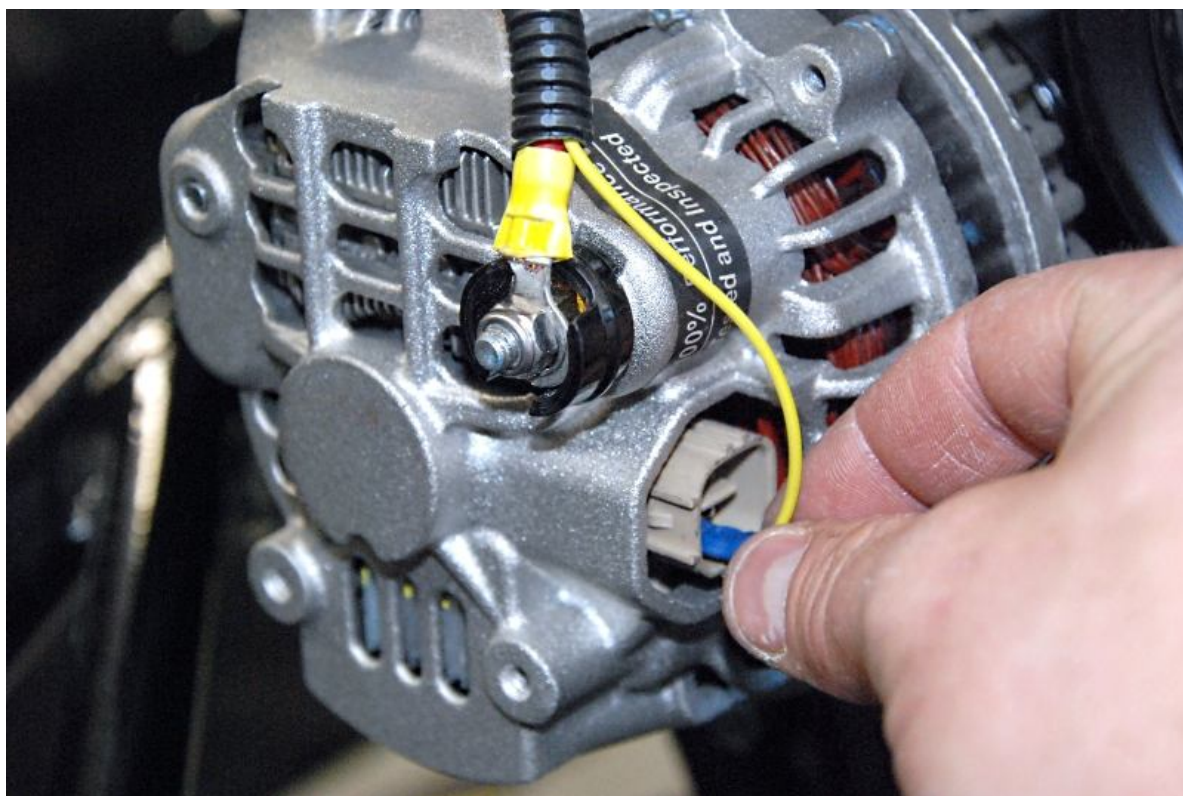

Connect the wire to the "Ignition" connector on the Alternator.

Accelerator Pedal

✂ $\frac{5}{32}$ " Hex key, $\frac{7}{16}$ " wrench, Marker, $\frac{3}{16}$ ", $\frac{1}{4}$ " drill bits, drill, hack saw, masking tape, clamp

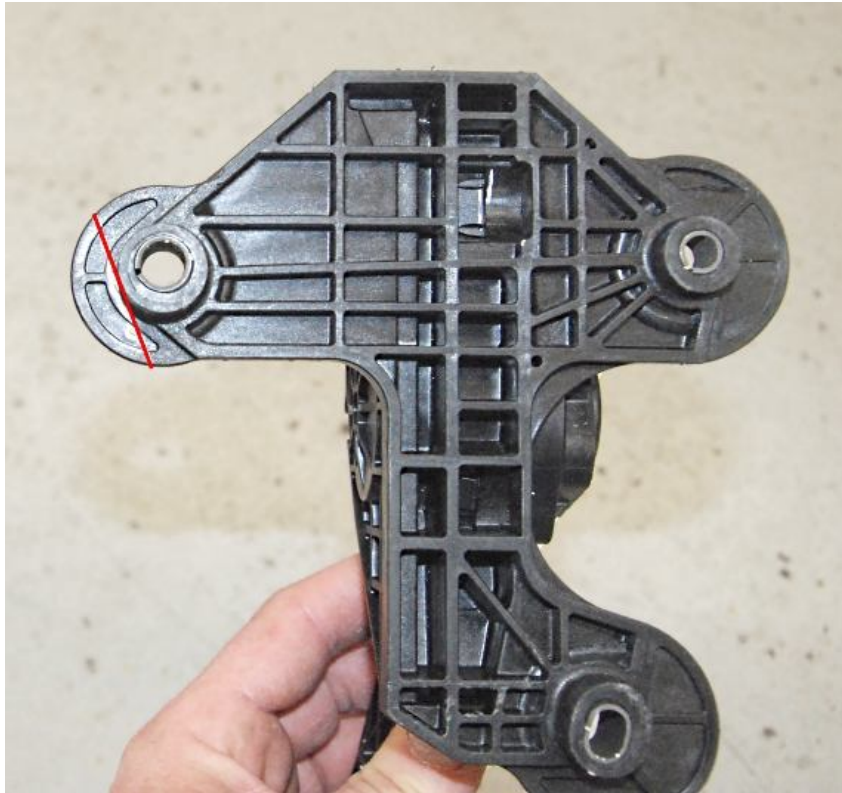

Use a hack saw to remove the extra part of the right pedal mount.



Mark where the bend is in the pedal.



Cut the pedal at the point marked. On the pad part, if desired trim the stalk down to the top of the pad.



Tape the pedal pad to the stalk on the mount part of the pedal and hold the pedal up in place in the pedal box. Readjust the location of the pad up and down as desired.



The higher the pad is located the harder the pedal will be to press due to the internal springs in the stock pedal mount.



Remove the pedal and locate the larger pedal mount plate on the pedal so that the short side is on the solid side of the stalk and the longer side is under the pedal pad. Make the bracket flush with the bottom side of the pad.

Holding the aluminum in place on the stalk, turn the stalk over to see the hollow side.

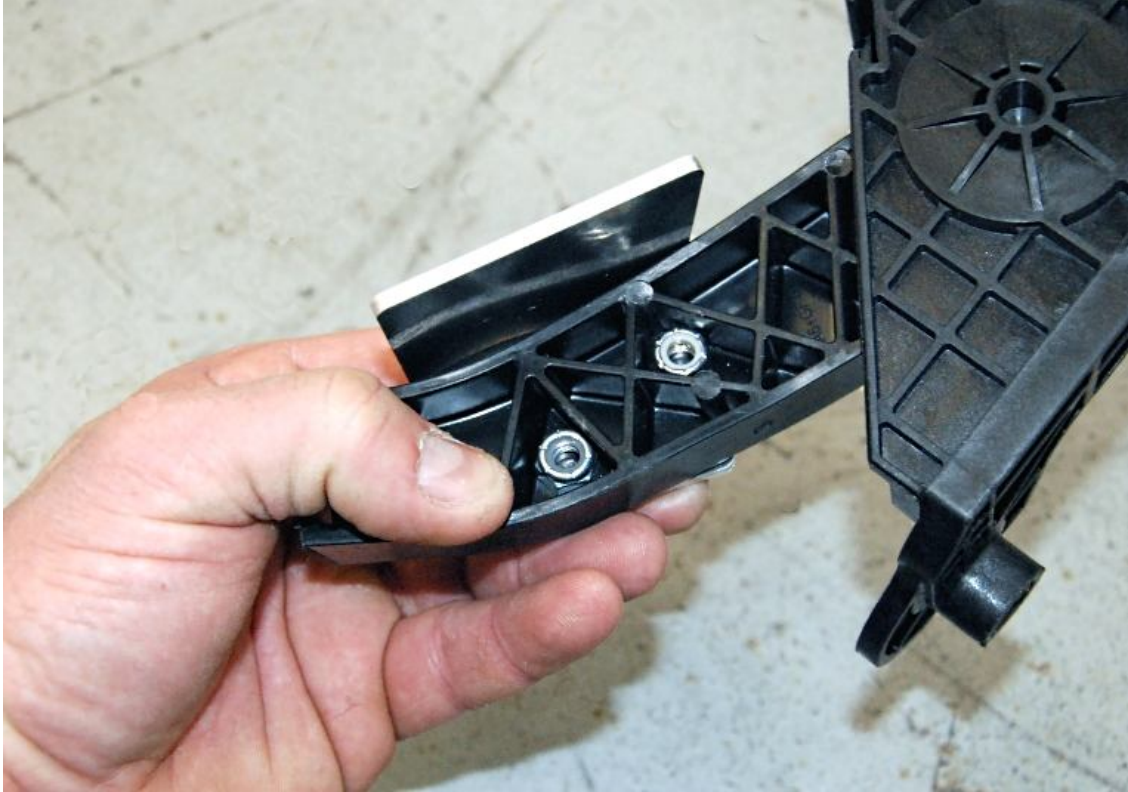

Set up two 1/4" nuts as drill guides for the bracket by putting two 1/4" lock nuts in the hollow part of the stalk so that the nuts are spread away from each other but still within the mount plate area.



Remove the mount plate and drill through the nuts and pedal stalk using a 3/16" drill bit.



Relocate the bracket using the pedal pad and mark the bracket through the holes in the stalk.

Drill through the bracket at the points marked using a $\frac{3}{16}$ " drill bit.

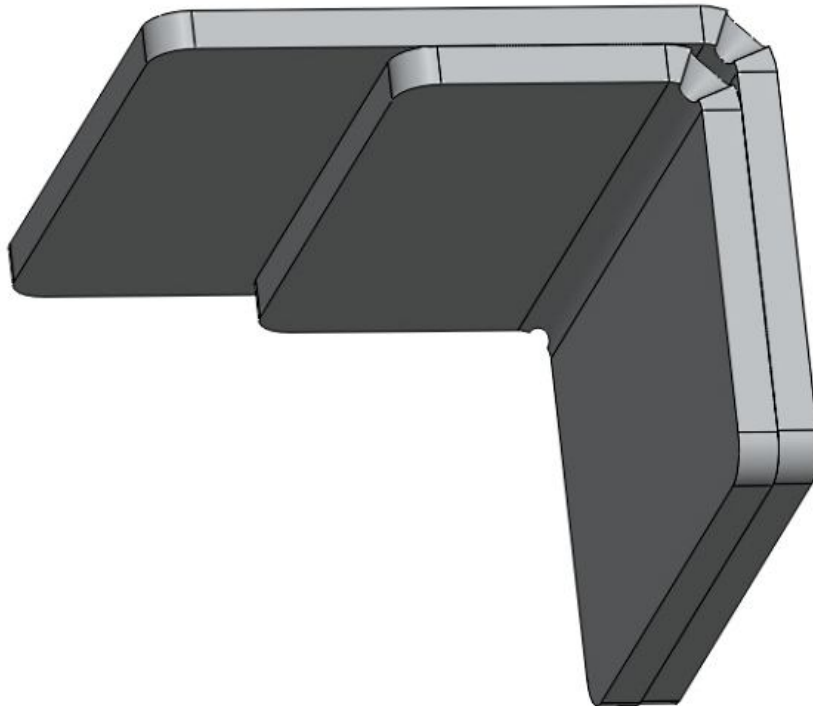

Stack the two mount brackets so that the sides are even and the tops are touching.



Clamp the brackets together so that the holes in the large bracket can be used as a guide for drilling the small bracket.

With the brackets clamped together still, open the bracket holes up to ¼"



Enlarge one of the holes in the stalk to ¼”.



Put a ¼” bolt through one of the brackets and the stalk, align the other hole then clamp the two together.



Drill the second hole out in the stalk to ¼”.



Bolt the two brackets to the stalk.



In the footbox, attach the plug to the pedal.

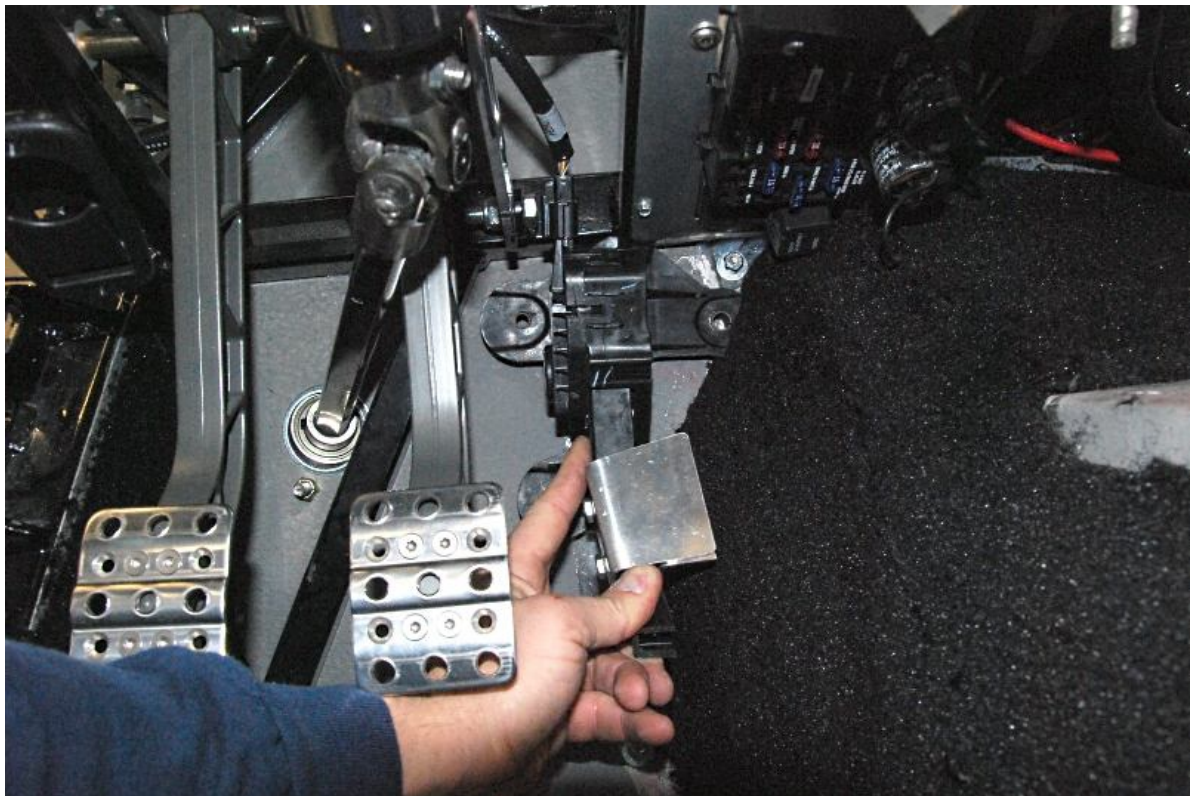

Hold the pedal up in the footbox area so that the pedal is as far over to the right as possible and as high as possible with the plug going up next to the steering column bolt.

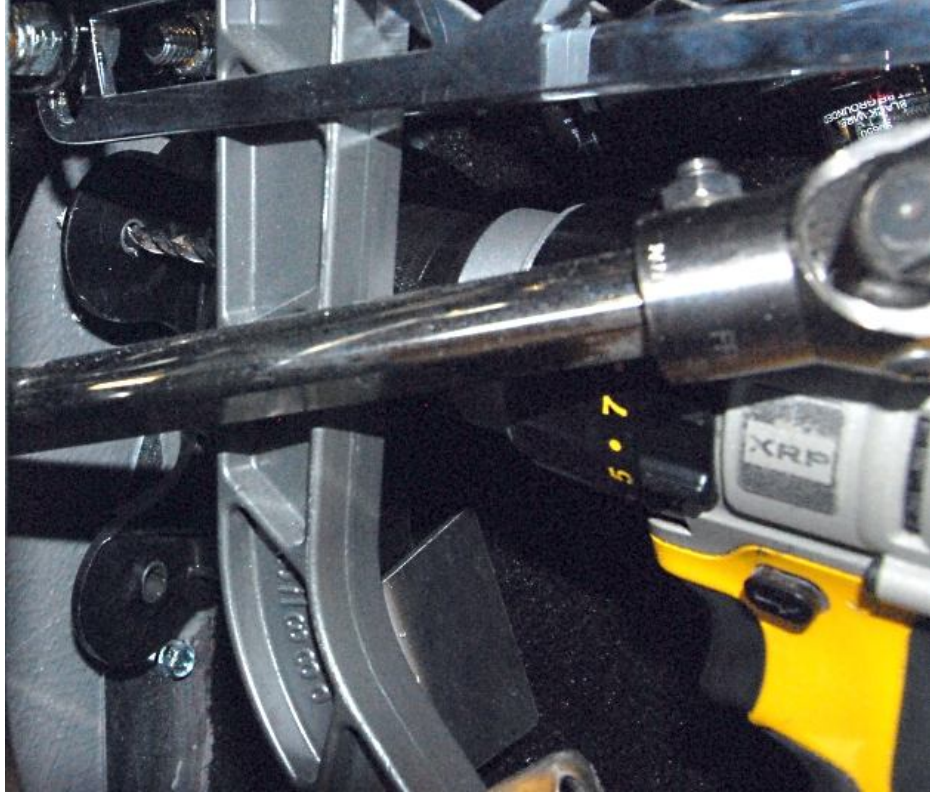

Drill through the top left pedal mount hole and the front of the footbox.

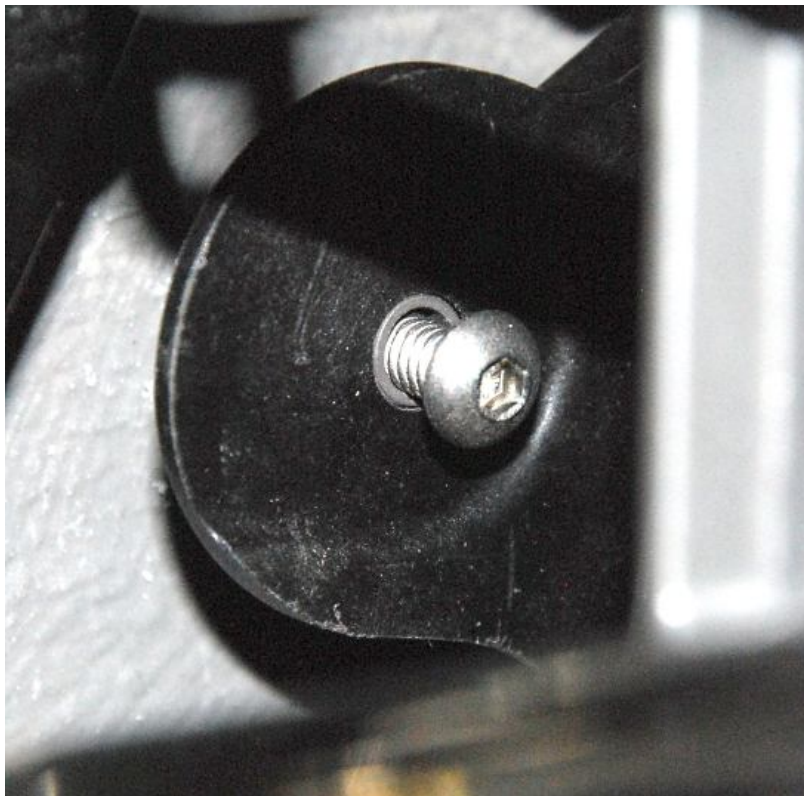

Insert one of the mount bolts through the pedal and hole just drilled.

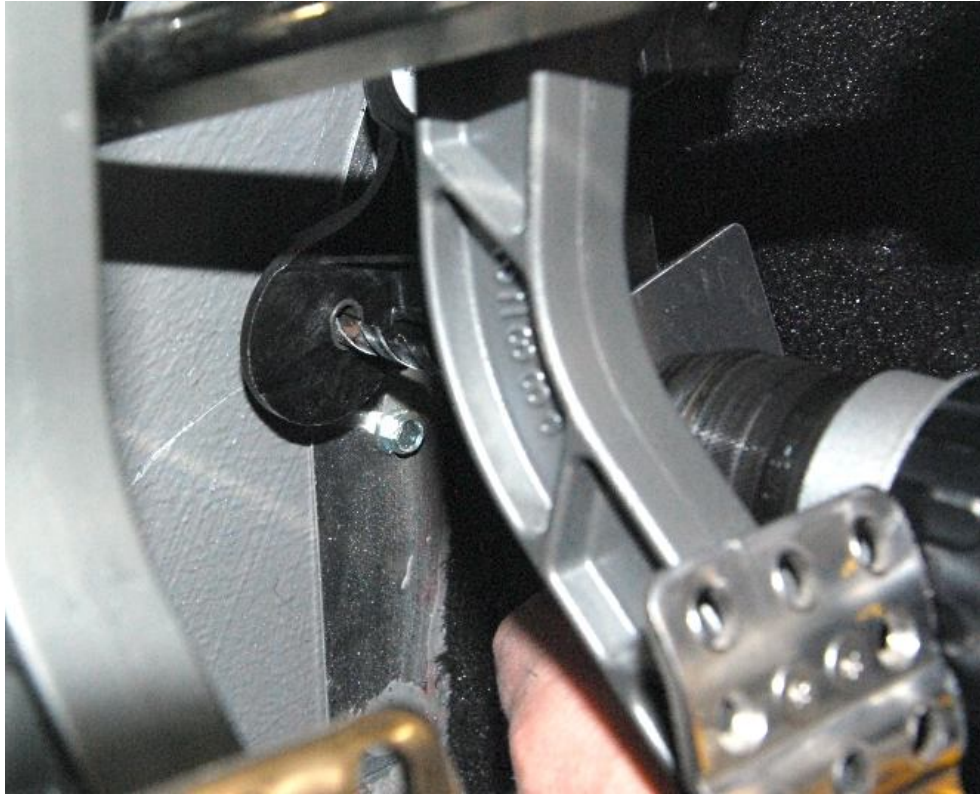

Check the alignment of the pedal and the plug then drill the bottom left mount hole.

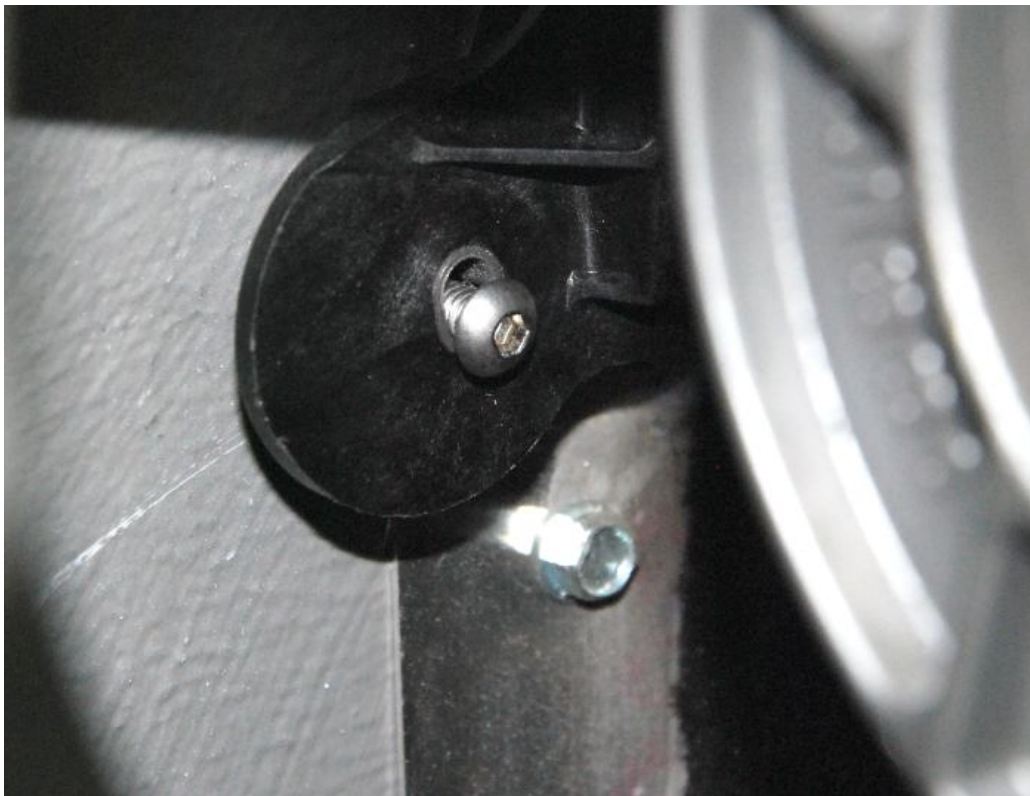

Insert another mount bolt.



Drill the top right pedal mount hole with a 1/4" drill bit.



Locate and tape the pedal pad to the mount plates on the stalk.

Un-plug and remove the pedal from the footbox



Mark the back mount plate in the vertical location of the center of the recess in the pedal pad so that the lock nuts will not hit the supports in the plastic.

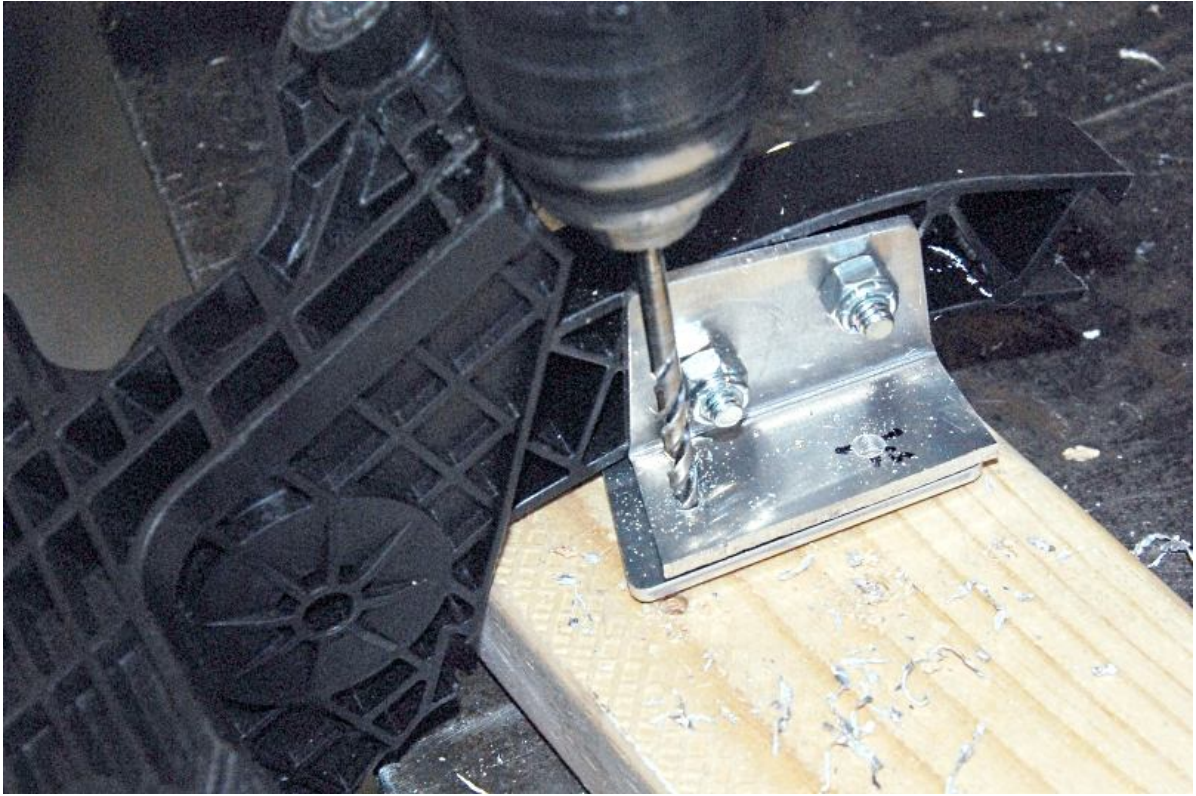

Drill through the middle of the mount plates at the heights marked so that there is enough room for the locknuts.



If you would like the pedal mount brackets to “disappear”, tape off and paint the brackets and mount bolts using flat black paint now.



Check the angle of the pedal pad then clamp the pedal pad to the mount brackets.

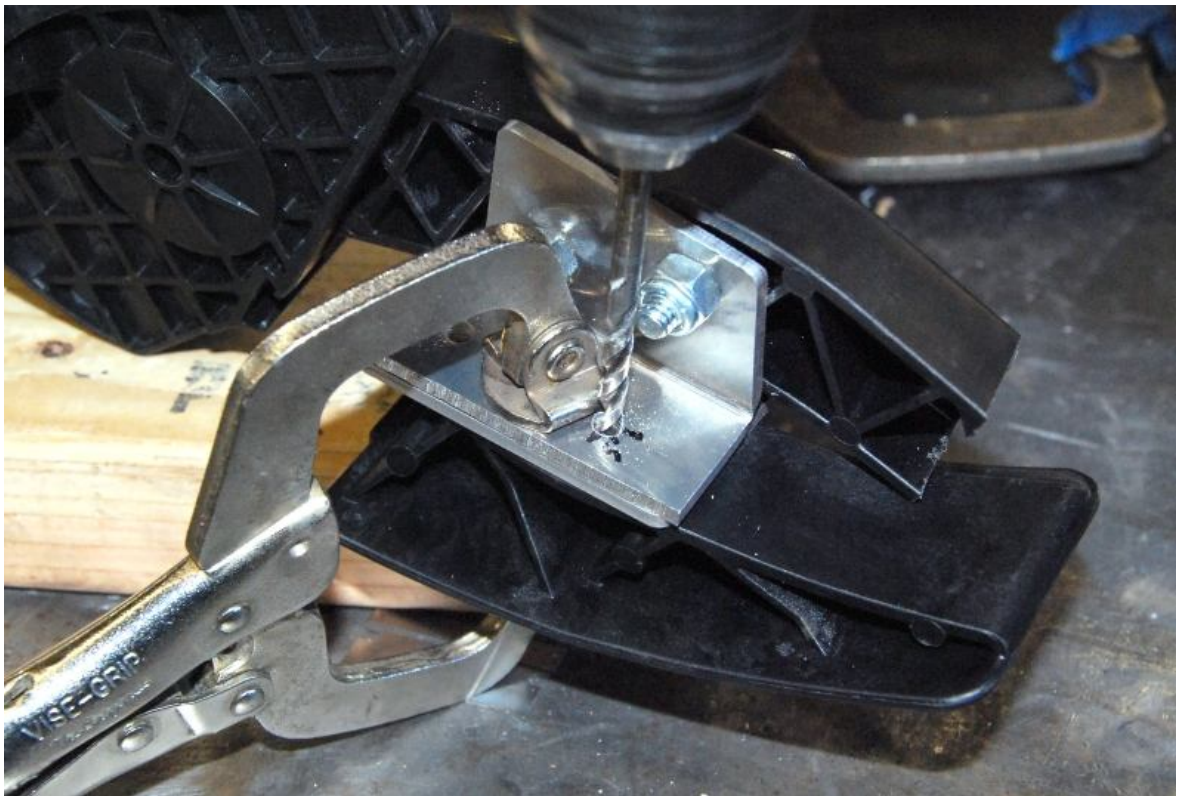

Drill through the back of the pedal pad into the recess.



Attach the pedal pad to the mount brackets



Finished Accelerator pedal assembly.



Connect the harness plug to the pedal.

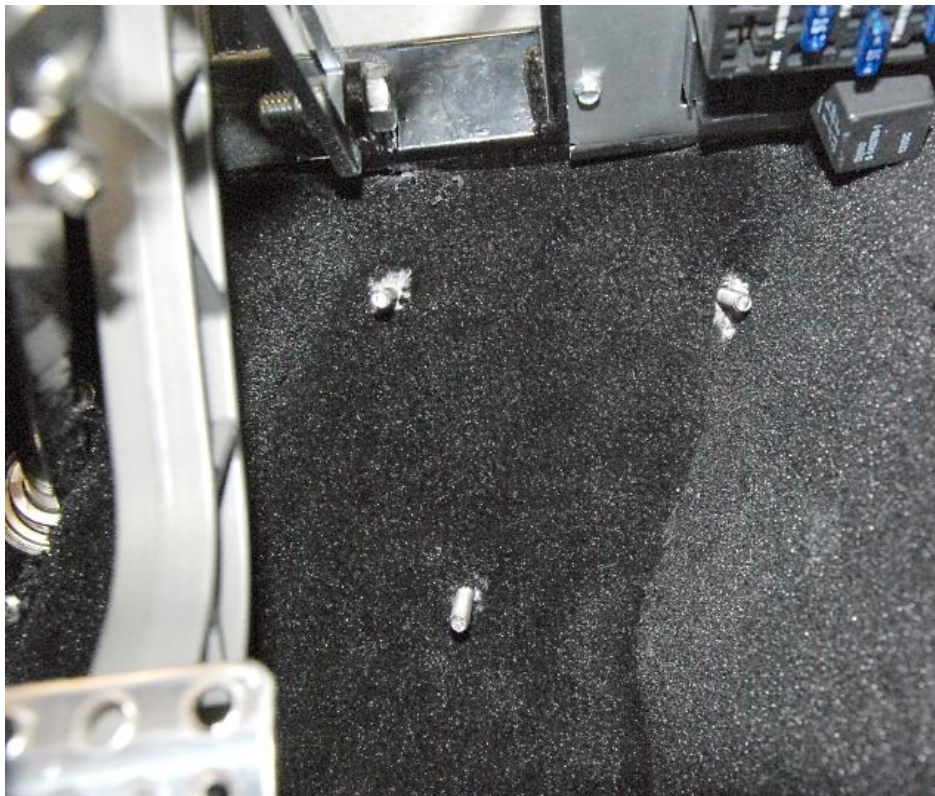

From the engine bay side, insert the mounting screws through the firewall into the cockpit.

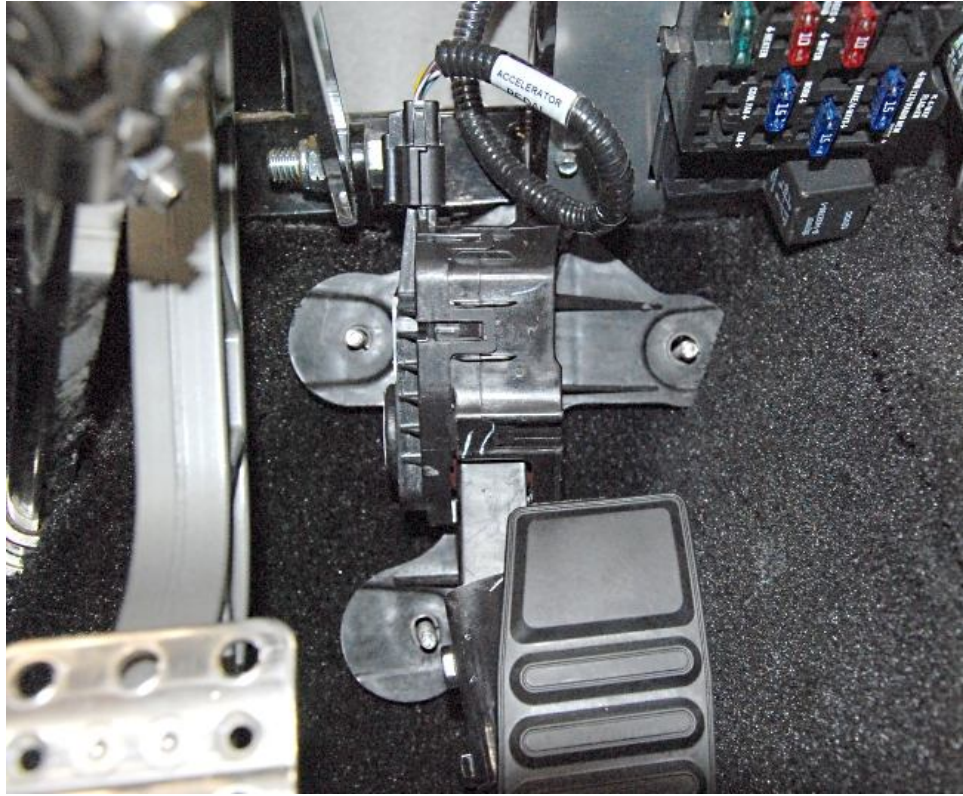

Put the pedal on the mounting bolts.

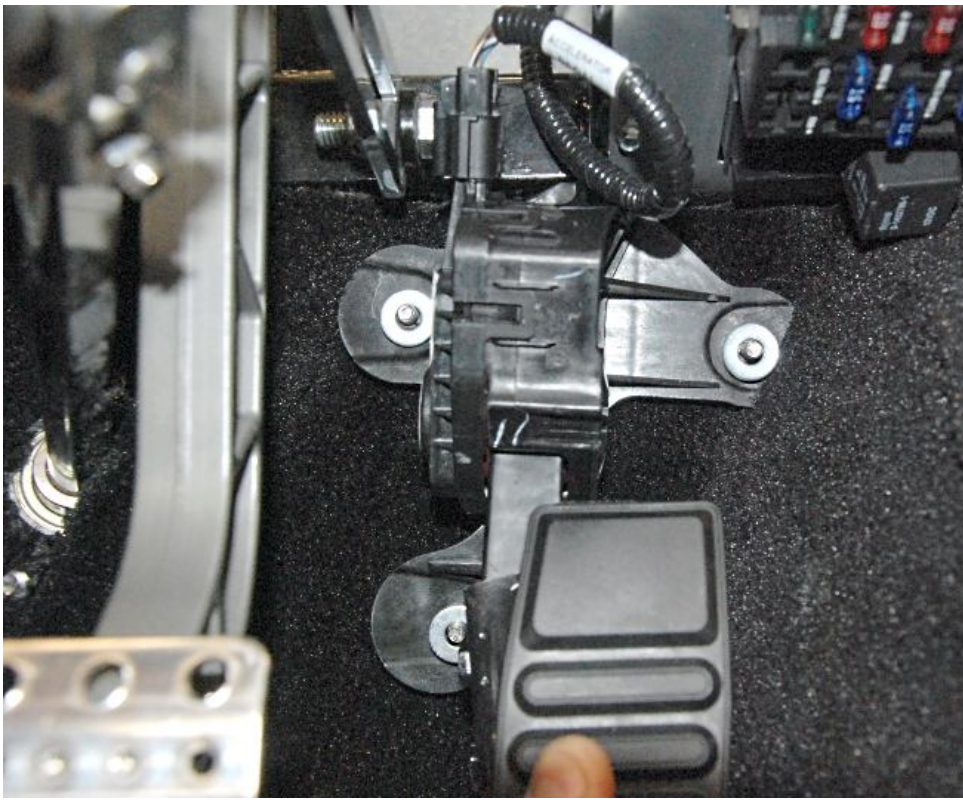

Put washers on the pedal mount bolts.

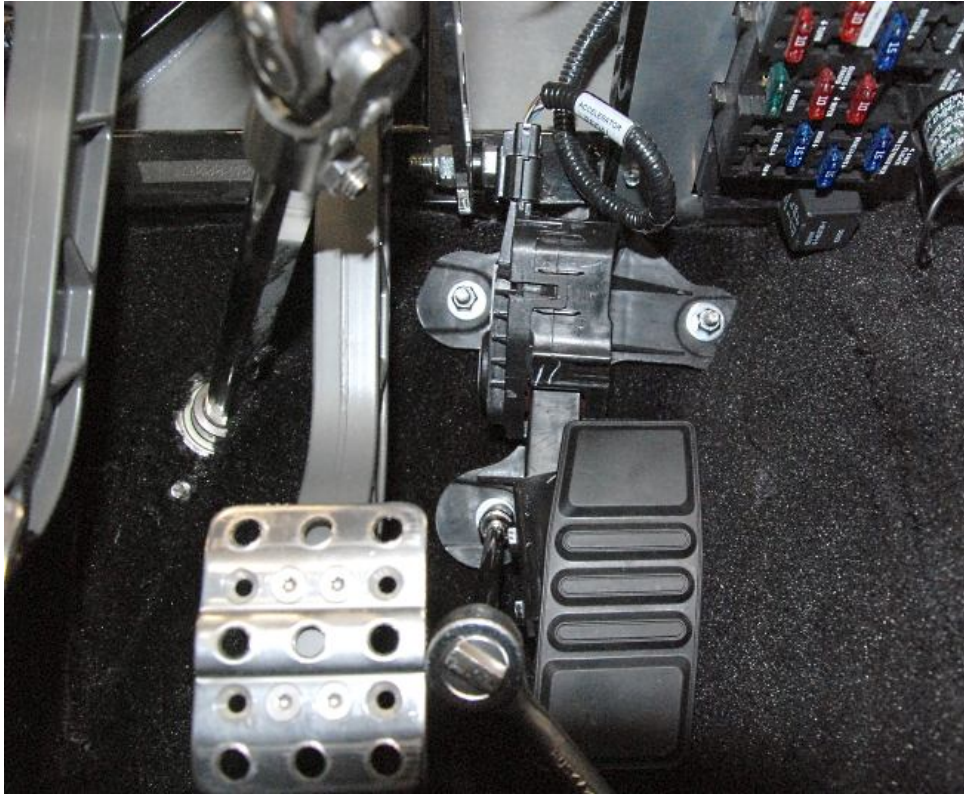

Tighten the mounting bolts using a $\frac{7}{16}$ " socket, ratchet and $\frac{5}{32}$ " Hex key.

Air Intake

Mass Air Meter

- ✂ T-20 Torx driver, Philips head screwdriver, Sensor safe RTV
- 🛠 Mass air meter, silicone hoses, intake tubes, air filter

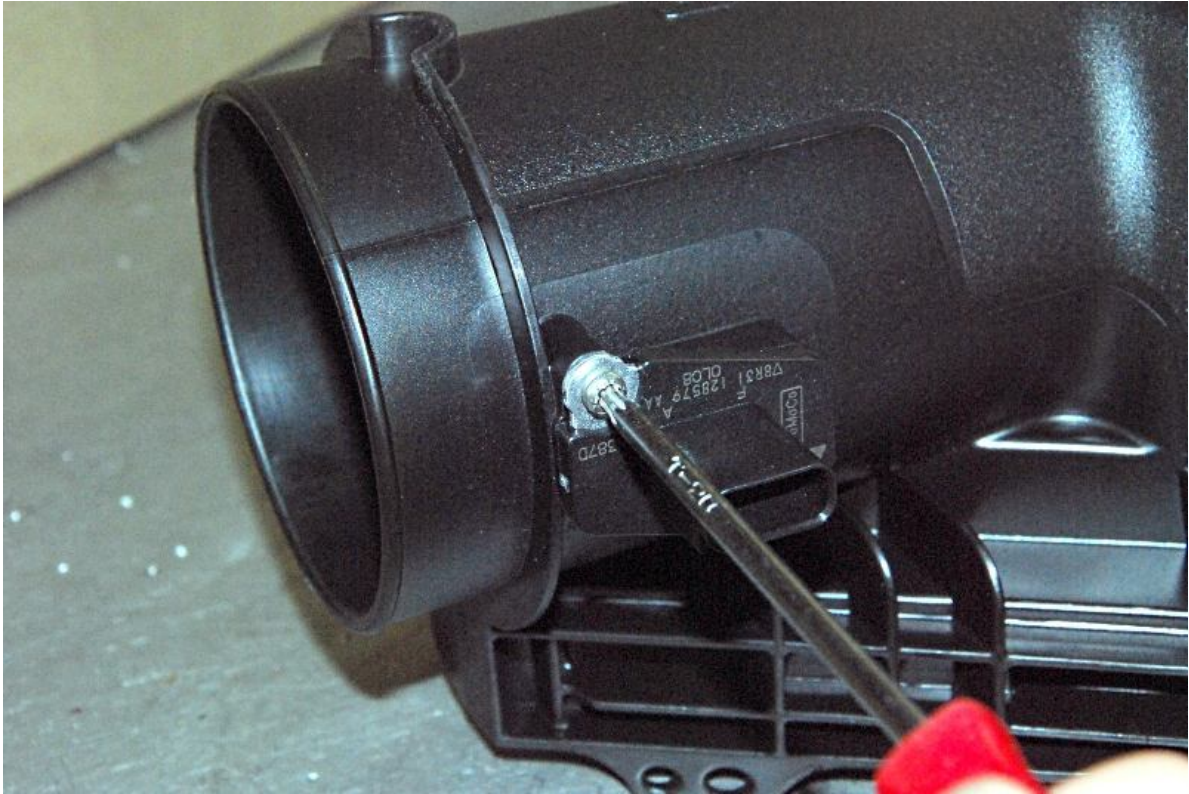

Unscrew the mass air sensor from the Ford intake using a T-20 Torx driver



Remove the sensor and note the direction of the curved part of the sensor.



Install the rubber ring into the intake mount.

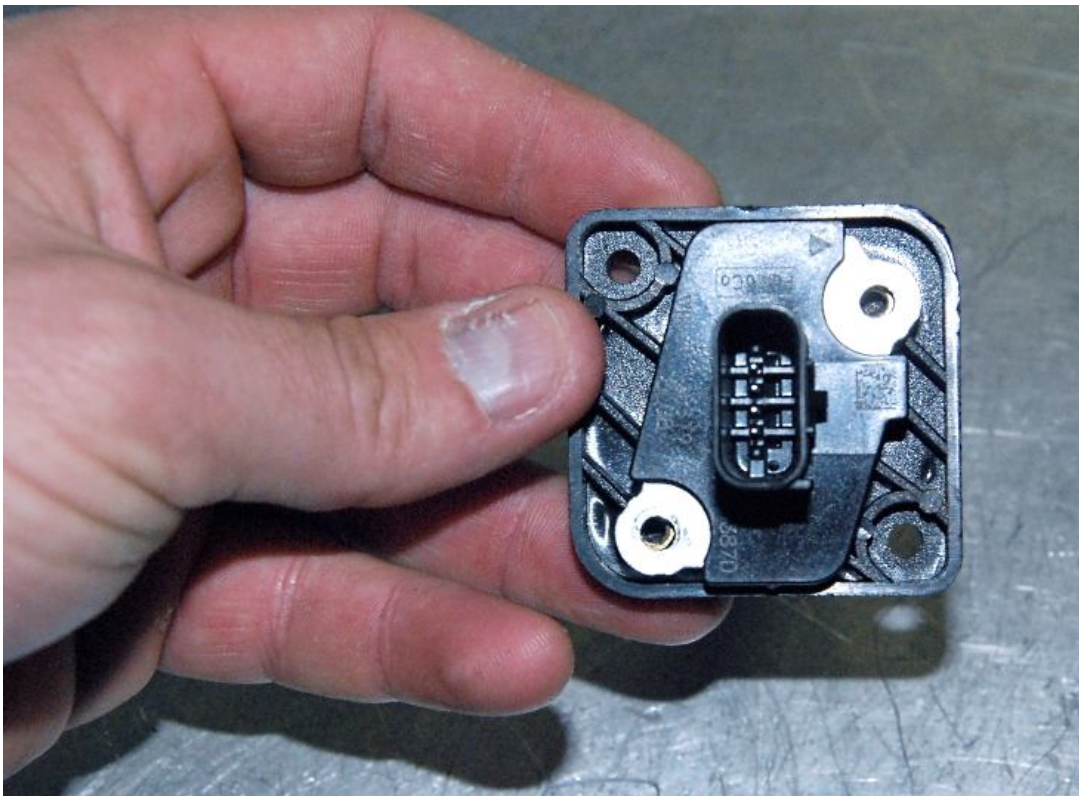

Insert the sensor into the mount to determine which way around it needs to go so the sensor mount holes will line up and the sensor will mount the correct way.



Attach the mount to the intake tube using the long screws so that the flat side of the sensor will face the “Spectre” writing.

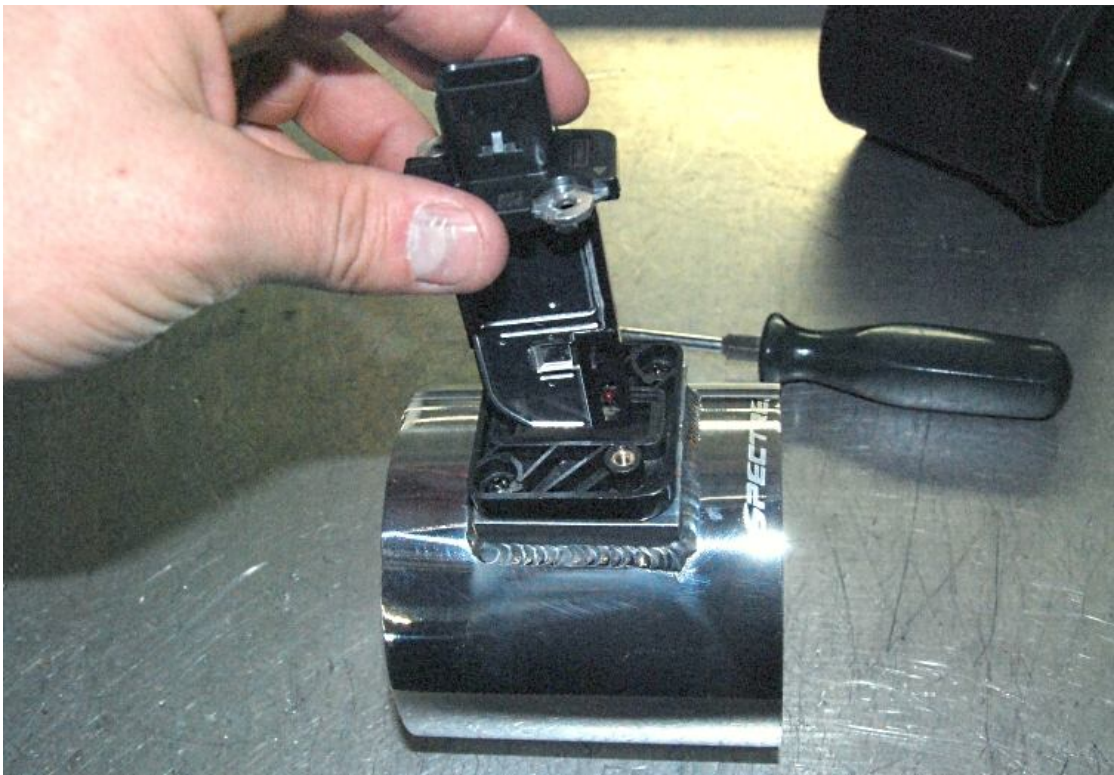

Install the sensor on the mount using the short screws so the flat side of the sensor will face the “Spectre” writing.



Run a bead of Sensor safe RTV silicone around the flange of the large plastic reducer.



Slide the Mass Air Meter tube flat sensor side first (Spectre writing) down onto the plastic reducer.

Wipe any excess RTV off the tube.



Turn the mass air meter over so the Reducer is on the top and let the RTV dry overnight.

Intake tube



Slide the Mass Air Meter tube flat sensor side first (Spectre writing) into the air filter.



Adjust the Mass air meter so that the mass air plug is on the far side as the Ford Racing instructions recommend.



Tighten the hose clamp.

Connect the elbow tube to the mass air meter using the silicone connector; only tighten one of the hose clamps right now.

Attach the silicone reducer to the tube elbow.



Push the intake tube onto the throttle body and position the air filter so that it clears the upper control arm and engine covers (if used).

Tighten the hose clamps.



Push the mass air plug onto the mass air meter.

Exhaust

✂ 15mm, 17mm sockets, 15mm wrench
🔧 Coyote headers, straight pipes

👉 **The threads in the heads for the headers changed a couple times during production. Be careful when installing the headers bolts so the threads are not ruined. After removing the headers studs, compare the thread to the new header bolts.**

Production header bolt change dates:
From 3-22-10 to 9-8-10 M10 x 1.50 Coarse
From 9-8-10 to 1-18-11 M10 x 1.25 Fine
From 1-18-11 M10 x 1.50 Coarse

FFR supplies the course bolts only. If the fine thread bolts are needed, the specifications you require when you purchase the bolts are: M10 x 1.25mm x 25mm long grade 8.8 hex head bolt

👉 Insert and tighten all of the bolts by hand before tightening any with a wrench.



Attach the headers to the engine by inserting and tighten all of the bolts by hand before tightening any with a wrench.

Attach the connector pipes to the headers and kit exhaust system.

Starting the engine

☞ Oil, Coolant

If not already done, fill the engine with 8 quarts of the correct oil.



If not already done, fill the engine with coolant through the radiator cap. To help remove air from the system, remove the top cap until coolant starts going up the tube then recap and hose clamp.

Fill the coolant overflow container.

Set the Fuel pressure regulator to the correct pressure as described in the Ford Racing engine control instructions.

Start the engine and allow the engine to get up to 195°F- 200°F then allow to cool completely, it will suck coolant from the overflow.



Cooling fan is switched on at 195°F, turns off at 190°F. This is based on inferred engine coolant temperature. Engine coolant temperature is inferred from the cylinder head temperature. Inferred coolant temperature may not be the same as actual coolant temperature.

Once cool, check the radiator and coolant overflow container. Top up with coolant if necessary.