



Factory Five Racing, Inc.

Part Number: 15471	Revision:Q	Effective Date: 6/21/16	By: J. INGERSLEV
Document Type (indicate):			
<input type="radio"/> Bill of Material	<input type="radio"/> Drawing (may be attached)	<input type="radio"/> Specification	
<input checked="" type="radio"/> Assembly Instructions	<input type="radio"/> Operating Procedure	<input type="radio"/> Other	

Roadster Coyote Engine

Installation Instructions



Parts needed	3
Ford Performance Parts.....	3
Ford Motor Co. Parts	3
Summit Racing.....	3
Fuel System.....	3
Air Intake System.....	3
Other vendors.....	4
Autozone	4
Supplies.....	4
Information.....	4
Accelerator Pedal	6
Drivetrain	20
Engine prep	20
Exhaust.....	20
Alternator	20
Engine mounts.....	22
Oil Pressure sender.....	24
Water Temp Sender	26
Transmission Prep.....	30
Engine/Transmission Installation	32
Fuel System.....	33
Fuel pressure regulator	34
Fuel lines	35
Fuel pressure regulator vacuum.....	36

Cooling system.....	38
Vacuum ports and PCV vent.....	43
Tough emissions.....	44
Relaxed Emissions	46
Air Intake	48
Mass Air Meter	48
Intake tube.....	53
Spectre MAF Sensor	53
Treadstone MAF Sensor	55
Wiring	57
Speed Dial – 2011-2014.....	58
Diagram.....	Error! Bookmark not defined.
Computer Connector wiring	Error! Bookmark not defined.
Speed Dial connections	61
Harness install	61
Computer mounting.....	61
2015 & Newer Routing	69
Fuel Pump	72
Neutral Safety switch	74
Clutch position switches.....	75
Radiator Cooling Fan	81
2011-2014 prep	81
Wiring using the fuse panel.....	83
Wiring bypassing the fuse panel.....	84
2015 direct wiring	87
Power/start	87
2011-2014	88
2015 & newer.....	89
Tach	91
2011-2014	92
2015 & newer.....	93
Alternator	93
O ₂ Harness.....	93
2011-14	93
2015 & Newer.....	98
Starter Solenoid.....	99
2011-2014	100
2015 & Newer.....	103
Black circuit Board box	106
Power Distribution	110
OBD 2 Port	111
General.....	112
Exhaust.....	113
Starting the engine.....	114

Parts needed

Ford Performance Parts

- M-6007-M50A - 5.0L Engine
- M-6017-A504VA – 2011-14 5.0L engine control pack with speed dial wires
- M-6017-A504V – 2015 & newer 5.0L engine control pack
- M-7003-R58C - TKO transmission
- M-7771-A – Bellhousing bolt kit
- M-9680-M50 – 5.0L engine cover kit
- M-7007-A – Transmission Sandwich plate
- M-6392-M46 - Bellhousing
- M-7560-T46 – Clutch kit
- M-7515-A – Clutch fork
- M-6375-G46A – Flywheel (If not already on engine)
- M-7548-A – Clutch Release Bearing or Ford motor F7ZZ.7548.AA
- M-6397-A46 – Clutch bolt kit
- M-7600-B – Pilot bearing (If not already on engine)
- M-8600-M50BALT – 5.0 Alternator Kit
- M-4209ADPT-AC - Speed Dial (speedo signal changer, 2011-2014 only)



Ford Motor Co. Parts

- F3LY-6C070-A – Flywheel access hole plug
- BR3Z-8260-BA – Mustang upper radiator hose
- W500310.S438- Starter bolts (3 needed)
- BR3Z-6379-A – Flywheel bolt (8 needed)
- AL3Z-6890-A – 2015 & newer only - Oil filter nipple to eliminate oil cooler spacer plate.

Summit Racing

FUEL SYSTEM

- AEI-13129 – 6AN Fuel pressure regulator
- SUM-220166B – 6AN O-ring to straight 6AN Adapter (2 needed)
- SUM-220701-B – 6AN to -6AN Hose Barb (1 needed)
- FRA-495110-BL – 6AN O-ring to straight -4AN Adapter (1 needed)
- SUM-220700-B – 4AN Hose Barb (1 needed)
- SUM-220711-B – 90° -6AN to -6AN Hose Barb (1 needed)
- SUM-800199 – 0-100 EFI fuel pressure gauge
- GSL392BX – Fuel Pump or VOR-8F002-265 Fuel pump
- VPN-400-939 – Fuel pump mount/barbs for GSL392BX pump

AIR INTAKE SYSTEM

👉 Two possibilities

- SPE-9741 – 4” to 3.50” Reducer adapter
- SPE-9771 - 4” hose coupling

SPE-9799 - 4" 90 ° intake tube
SPE-9705 - Mass Air Sensor filter adapter
KNN-RU-5149 – 4" ID x 6.50" long Air Filter

Or use

www.treadstoneperformance.com – MAPHL35
90° 3.50" Silicone hose
FFR air filter

Other vendors

AUTOZONE

2005 Ford Mustang GT Starter – DL3299S or similar*
Short oil filter - Fram PH10060 or Mobil M1-113 or STP S10060

Morosso – Oil Pan (Coyote #20570 and pickup #24570)

Supplies

Oil – See instructions with engine - 8 quart
Coolant –2-3 gallons of **Dex-Cool concentrate**
Transmission fluid
Teflon tape

Information

These instructions assume that the customer has the Roadster Coyote Installation kit from Factory Five Racing.

Make sure to download the latest version of the engine controls instructions from the Ford Racing parts website: www.performanceparts.ford.com. Do a parts search for: M-6017-A504V and click on the instructions pdf.

Use the following diagram as a guide for harness locations.



1	Firewall extension
2	Engine starter
3	Engine computer
4	Power distribution point
5	Black fuse box
6	OBD 2 port
7	Accelerator pedal

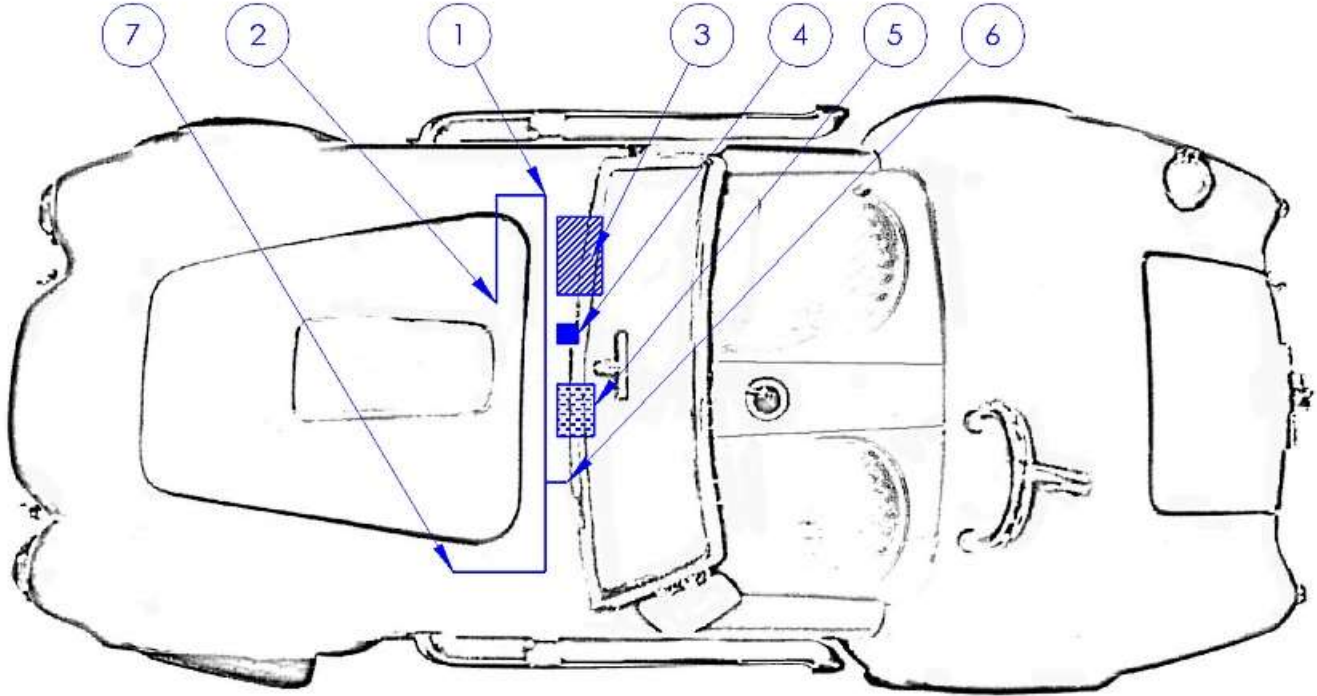

2011-2014 wiring layout

1	Firewall extension
2	Engine starter
3	Engine computer
4	Power Distribution point
5	Black fuse box
6	OBD 2 port
7	Accelerator pedal
8	Engine connection

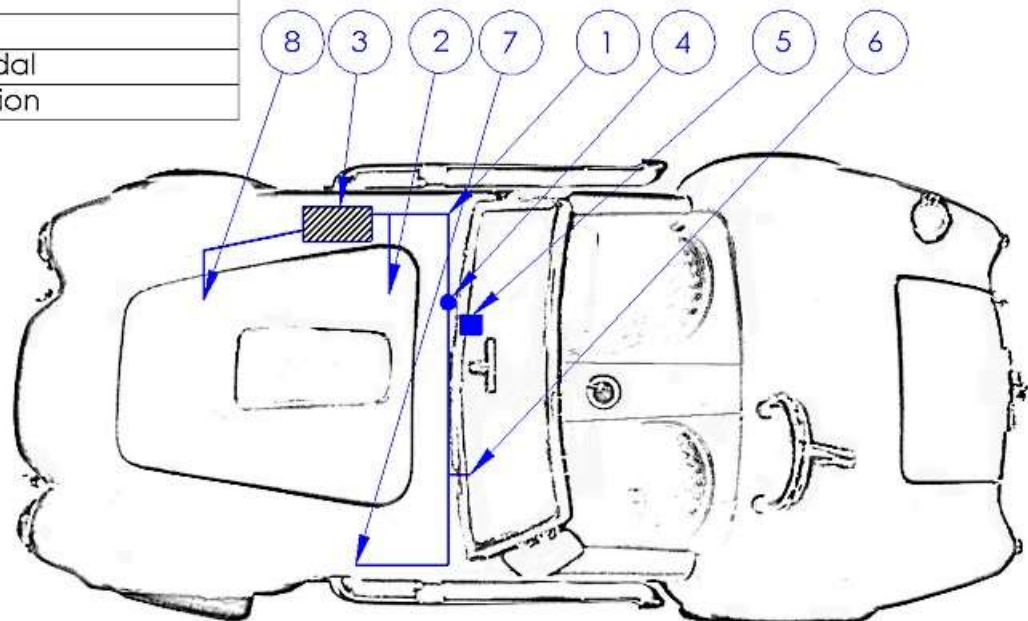

2015 & up wiring layout

Accelerator Pedal

- ✂ Hack saw, $\frac{5}{32}$ " , $\frac{3}{16}$ " Hex keys, $\frac{7}{16}$ " wrench, Marker, Grinder or drill bit, clamp, $\frac{3}{16}$ " , $\frac{1}{4}$ " drill bits, drill





Use a hack saw to cut the right mount off the accelerator. Cut right against the flat section of the pedal so it also cuts the top Webbing off.

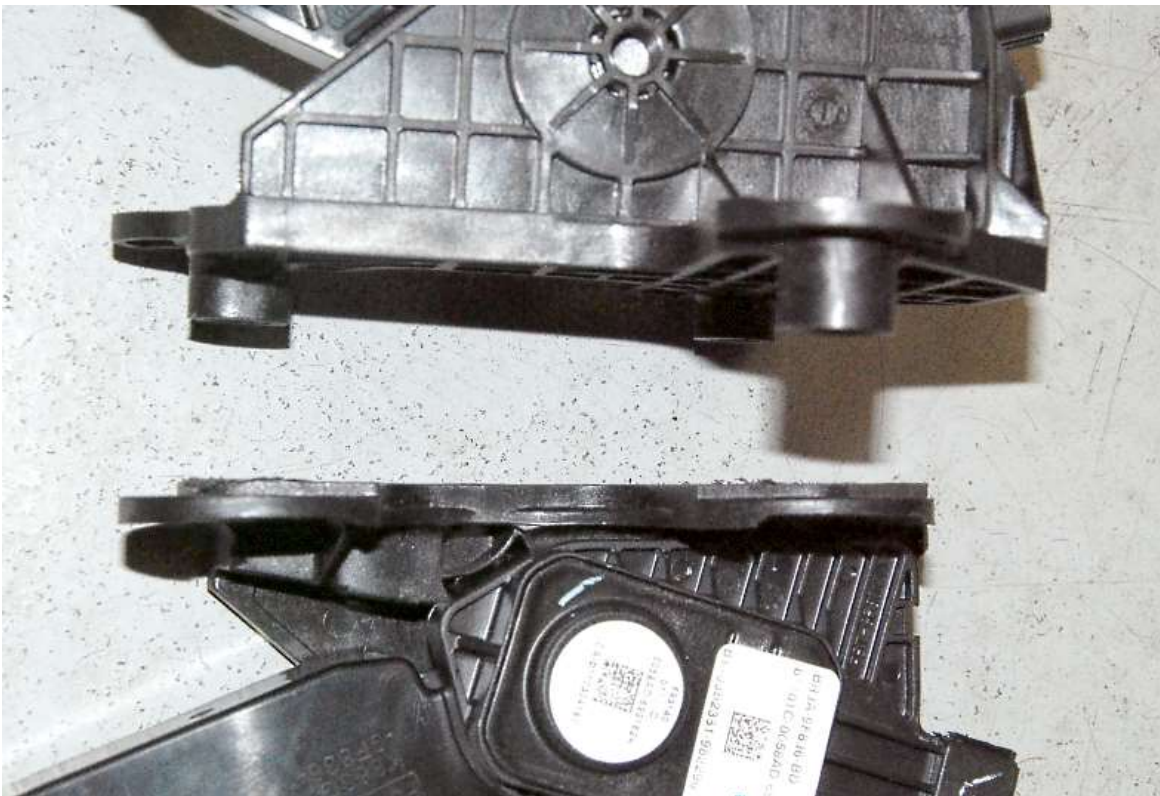

On the underside, cut the bottom mounts off with a hack saw so that the bottom is flat.



Cut the accelerator pedal.

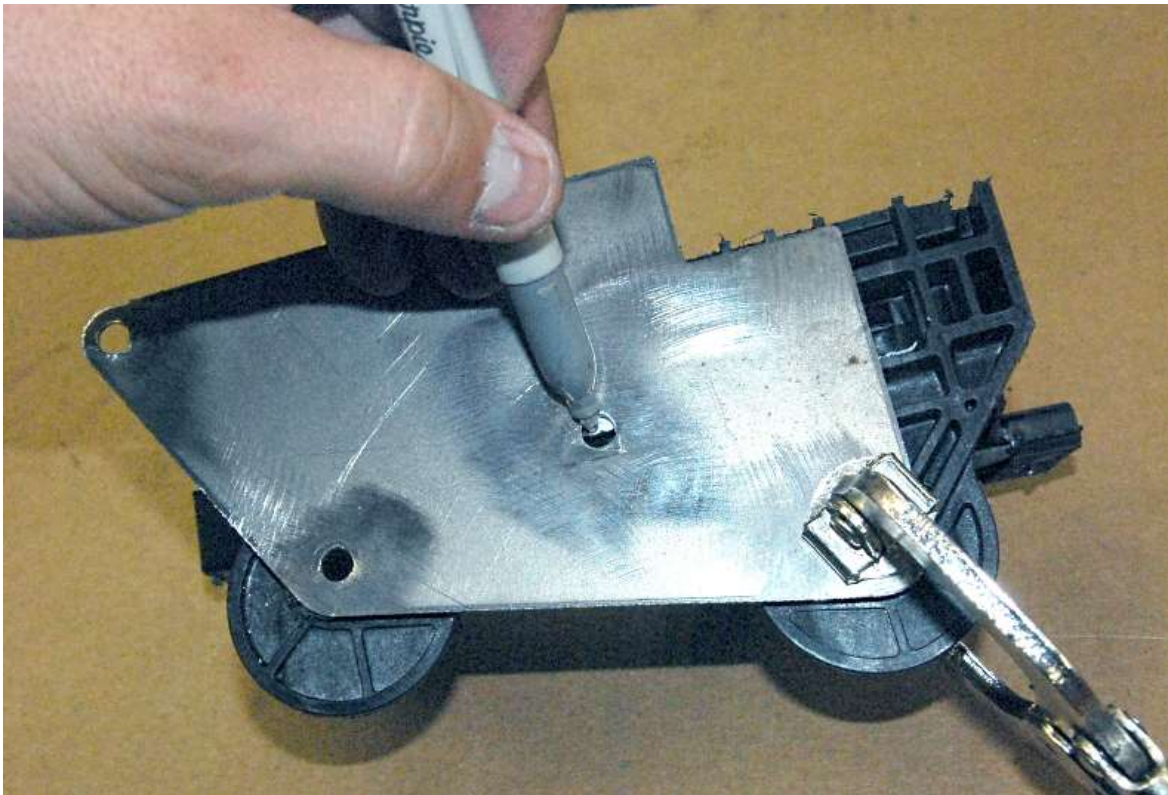

Align the mount holes of the pedal on the pedal mount and mark the pedal through the upper frame mount hole.

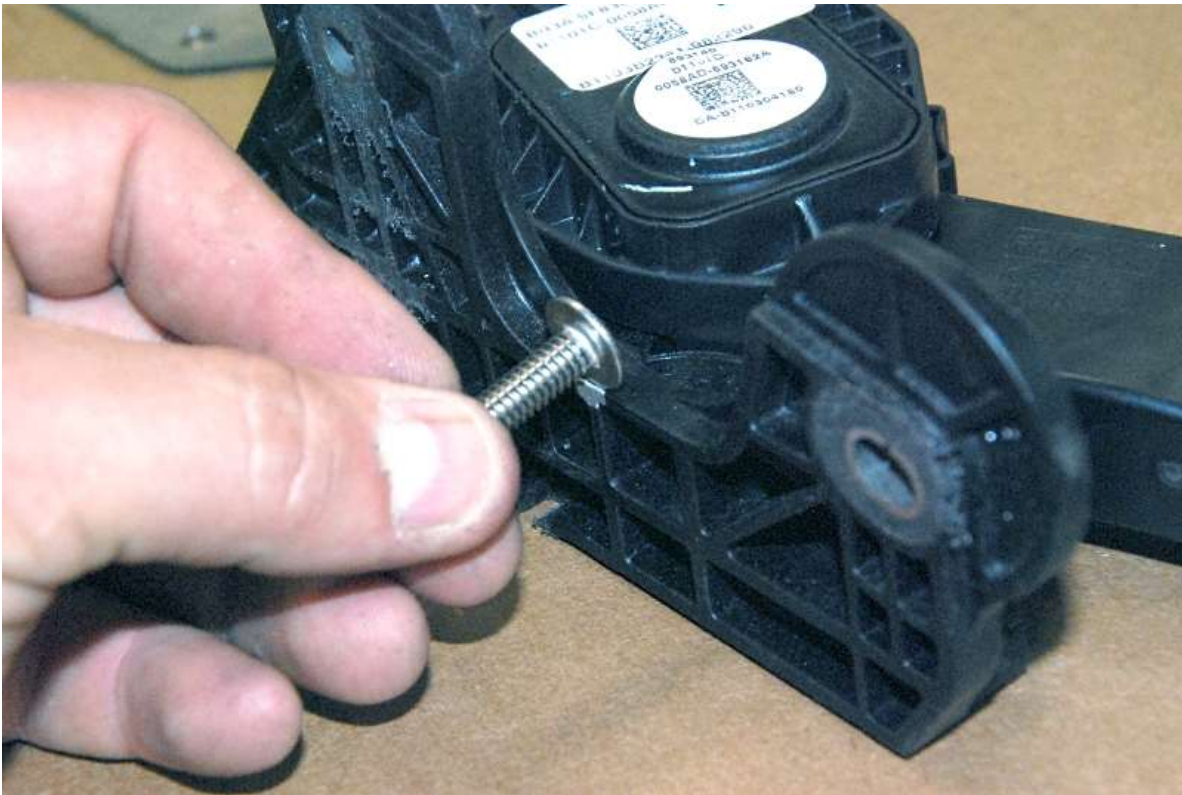

Hold up the mount screw to the pedal at the point marked.



Mark the pedal where the screw starts, stops and the height of the screw.

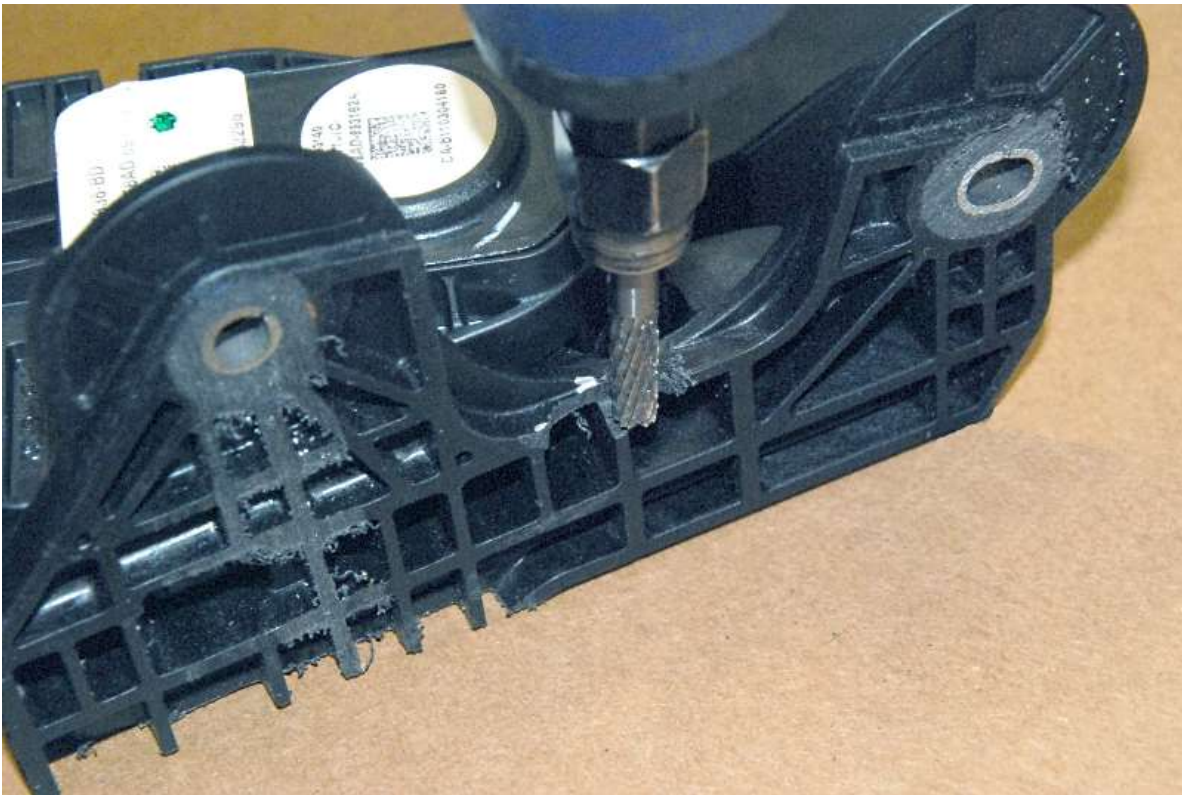

Use a grinder, hack saw or drill bit to remove material on the pedal for screw clearance.



Check the fitment of the mount screw by putting the pedal on the pedal mount with the screws.

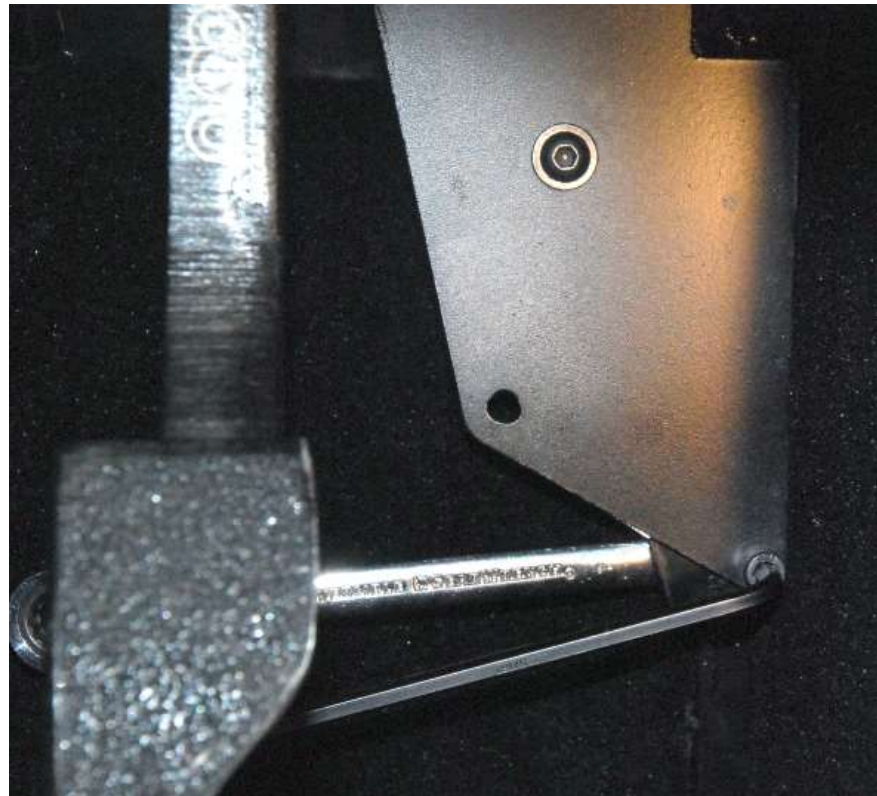
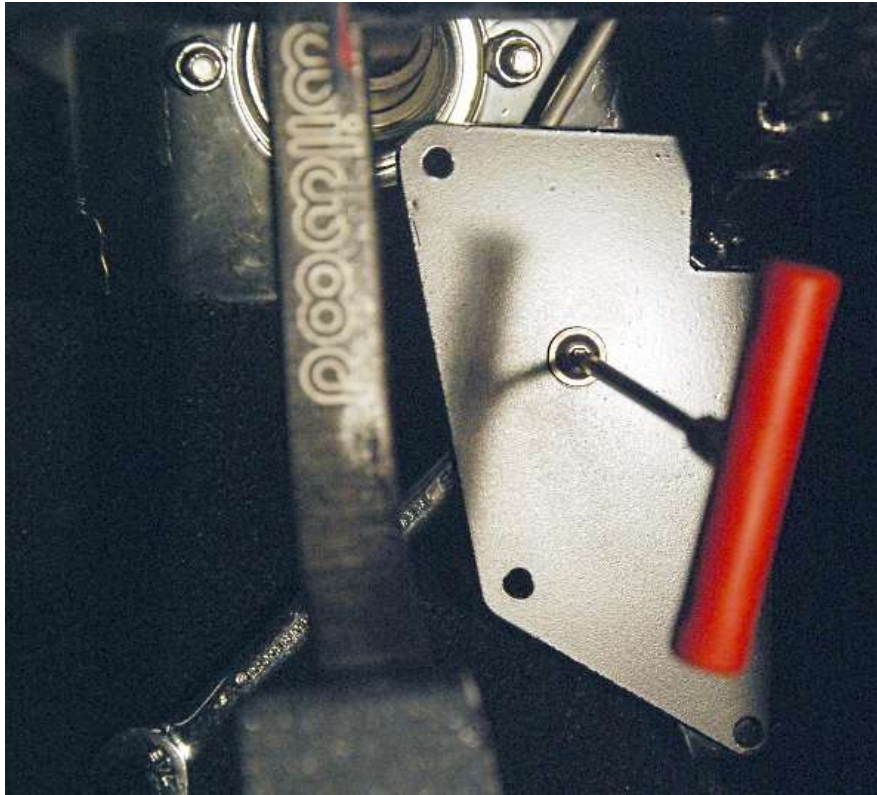

Attach the Accelerator pedal mount to the frame accelerator pedal mount using the 1/4" screws provided and the ones from the standard kit.

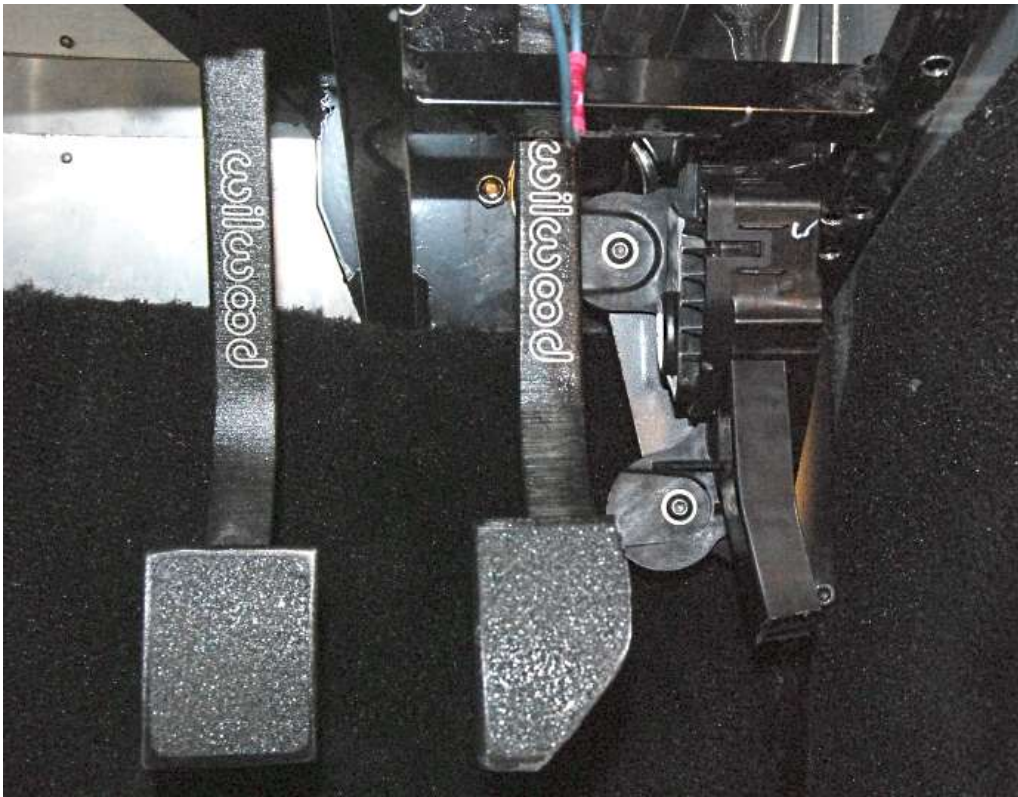

Attach the Coyote accelerator pedal to the new pedal mount.



Cut the FFR accelerator pedal at the bottom of the existing mount hole using a hack saw.

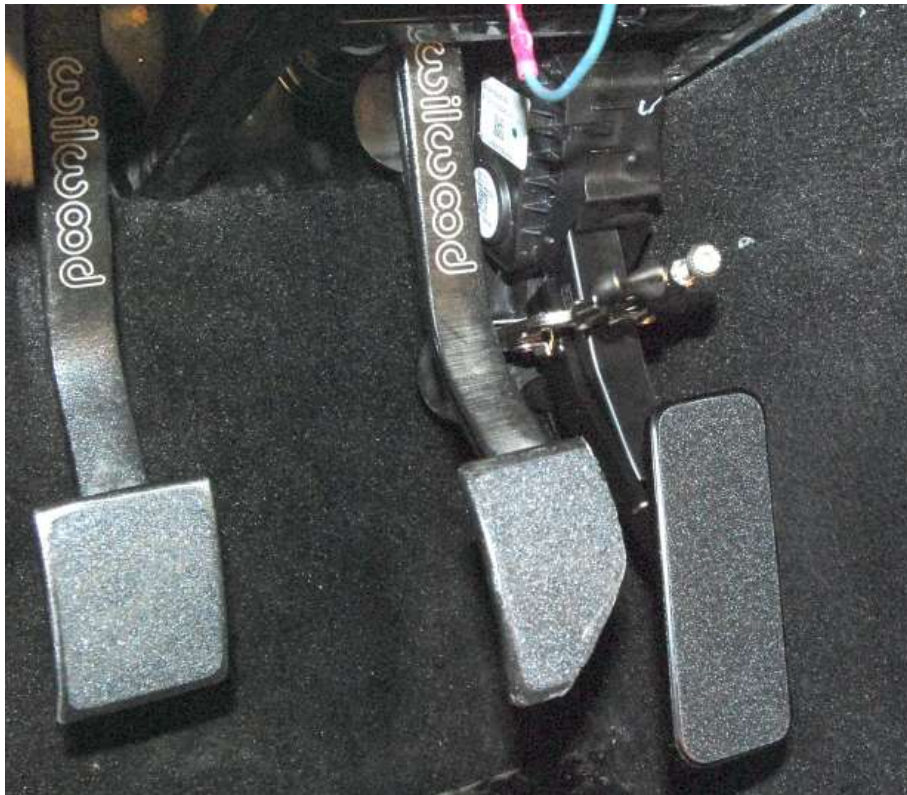

Clamp the FFR pedal to the Coyote pedal with a small clamp so that the accelerator pad is 2 1/8" back from the brake pedal.



This is a starting point



Sit in the car and push the brake pedal down as if you were stopping the car. You should be able to push the pedal down without hitting the gas pedal but be able to rock your foot (heel/toe) onto the gas pedal.

Once the correct height is set, mark the side of the coyote pedal using a paint marker.



Remove the pedal from the car and check the alignment of the two pedals with the line you just drew.



On the backside of the pedal insert one of the 1/4" locknuts into one of the recesses so that the bolts will be as far apart as possible and still go through both the FFR pedal and the Coyote pedal.



Using the locknut nylon as a guide, drill a $\frac{3}{16}$ " hole through the plastic pedal.

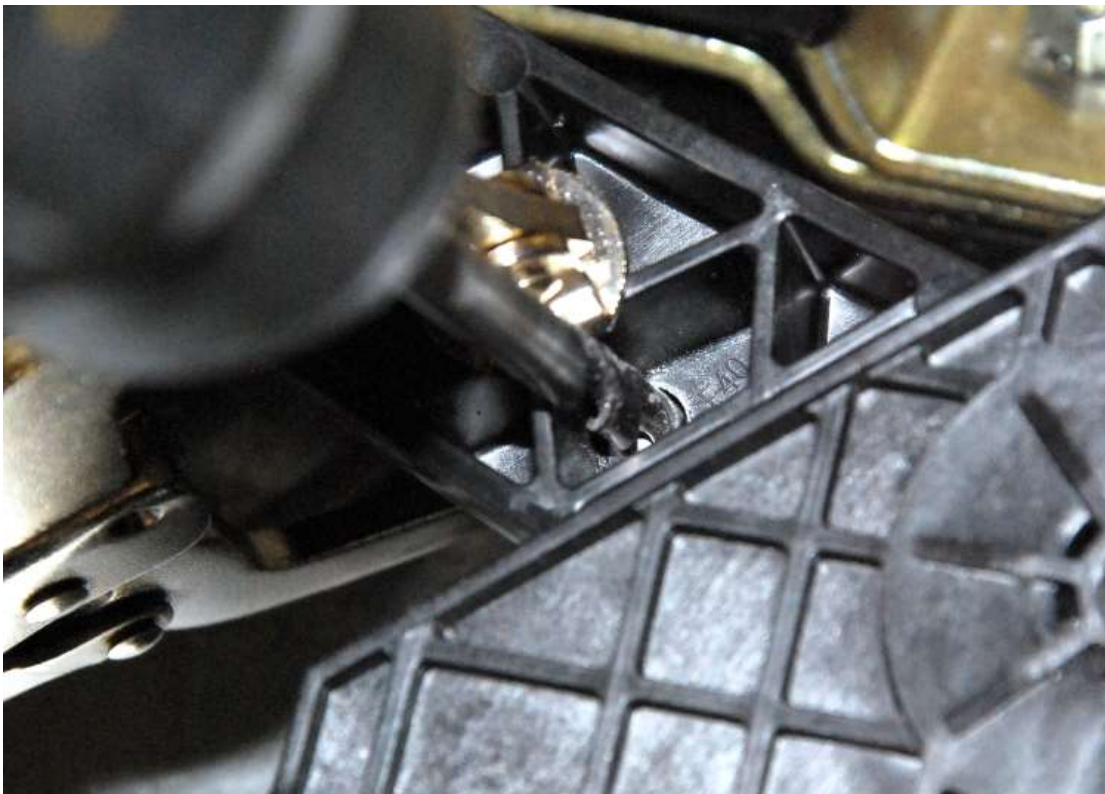

Remove the locknut and enlarge the hole using a $\frac{1}{4}$ " drill bit.



Check the alignment of the metal pedal on the plastic pedal then drill through the metal pedal using the plastic hole as a guide.

Attach the metal pedal to the plastic pedal using one of the $\frac{1}{4}$ "-20 x $\frac{3}{4}$ " screws and locknuts included with the kit.



If your pedal location requires bolting below the bend in the plastic pedal, mark the location of the bend.



Use a pair of pliers and a vise to slightly bend the metal pedal to match the plastic.

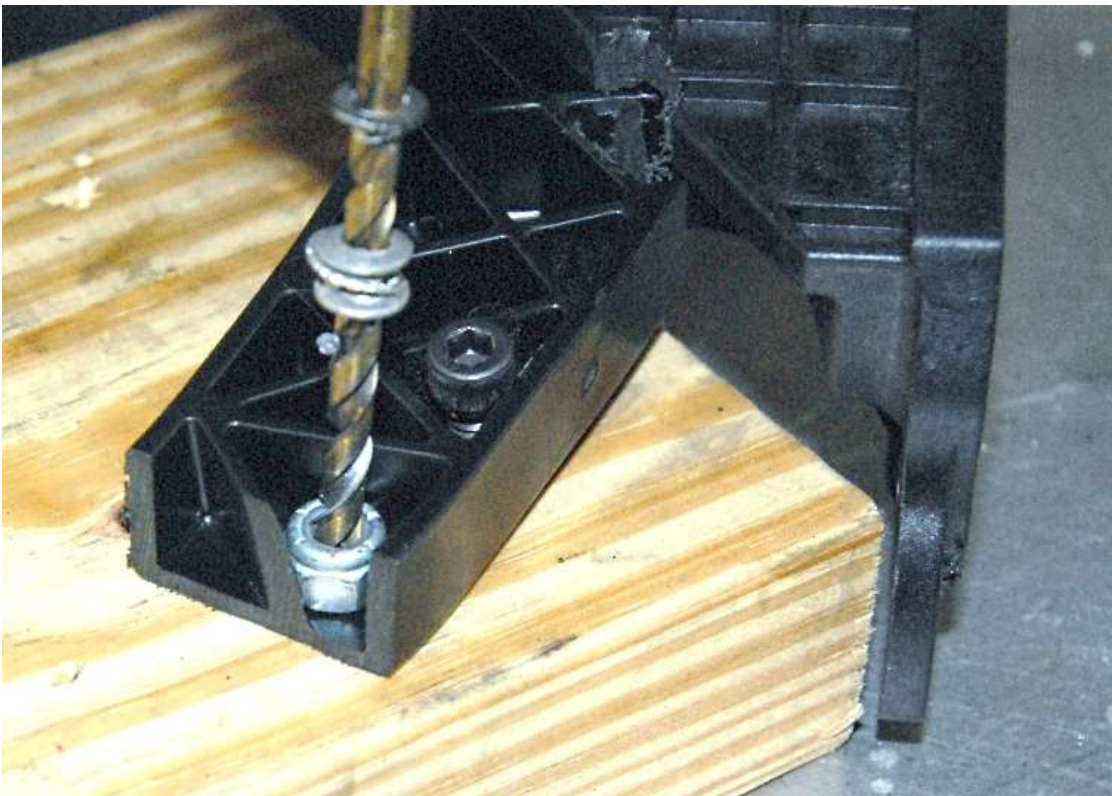

Use another lock nut and drill bit to locate the lower hole location and drill a pilot hole.

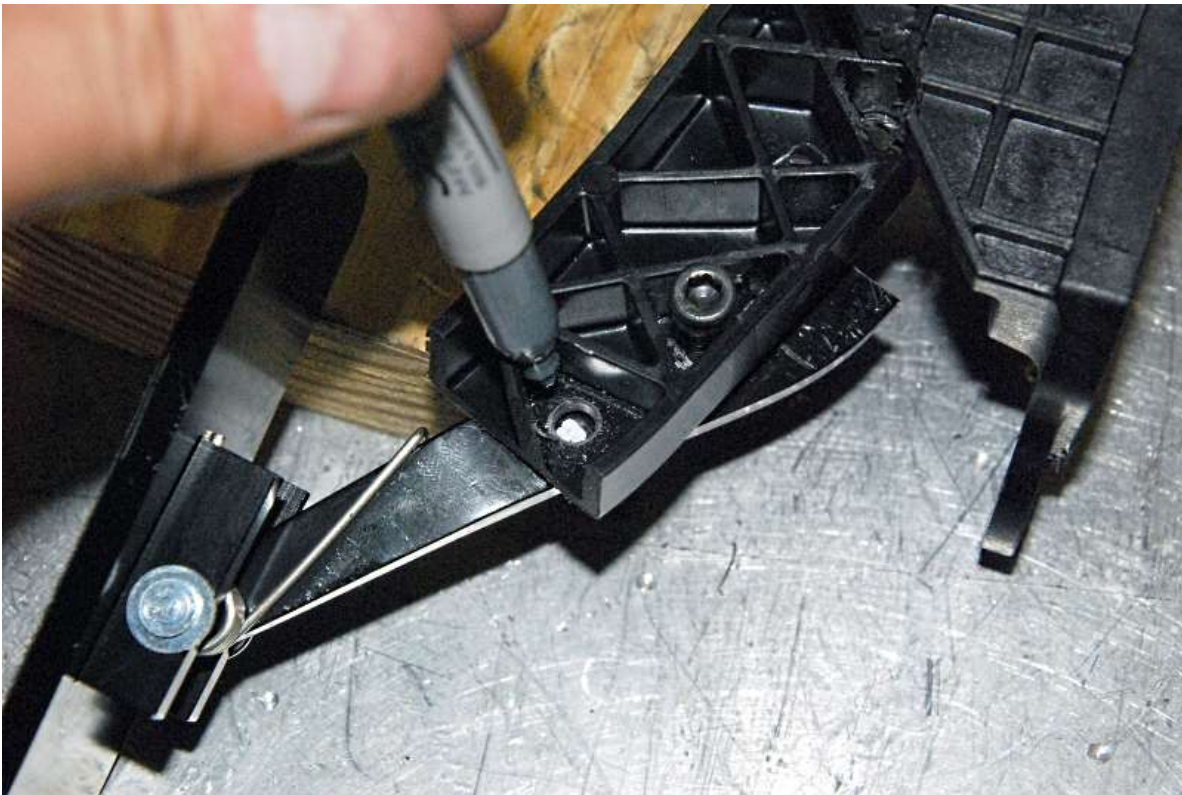

Mark and drill the location on the metal pedal.



Use one of the flanged $\frac{1}{4}$ "-20 x $\frac{3}{4}$ " screws in the lower hole.



Mount the pedal to the new pedal mount in the footbox.

Drivetrain

Engine prep

- ✂ 6mm, 10mm, 13mm, 15mm sockets, 13mm deep socket, ratchet
- 🛠 Ford Racing Alternator, pipe fittings, Shallow oil pan

Exhaust

Remove the Stock Mustang headers.
Remove all of the header studs using a 6mm 6 point socket.

Alternator

Install the Ford Racing alternator and tensioner per the Ford racing instructions

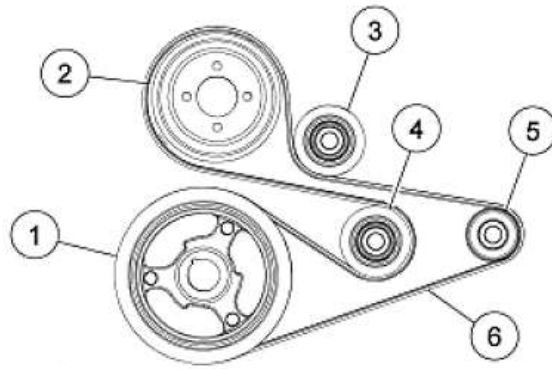

Item	Description
1	Crankshaft pulley (on engine)
2	Coolant pump pulley (on engine)
3	Accessory drive belt idler pulley (on engine)
4	Accessory drive belt tensioner pulley
5	Alternator and pulley
6	Accessory drive belt

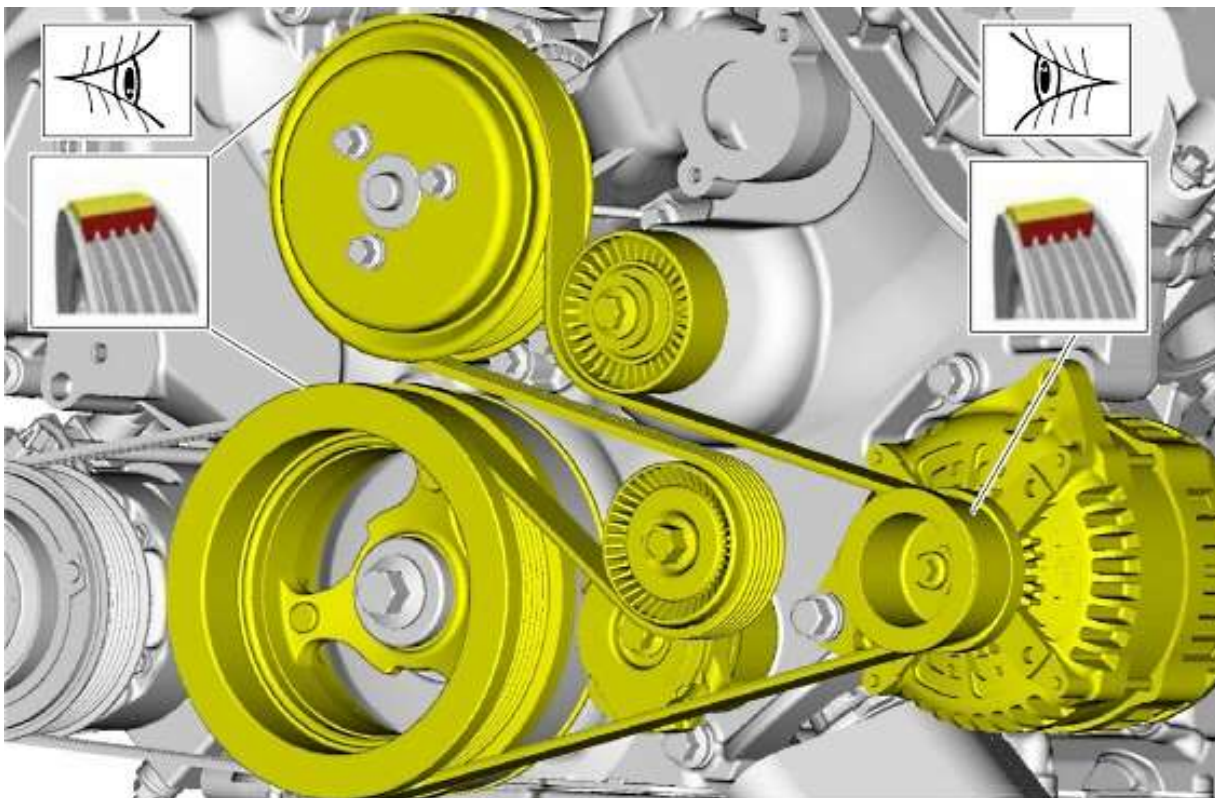

Route and install the serpentine belt.

Remove the stock oil pan and install a shallow oil pan.



On the left side of the engine, remove the wiring harness holder from the stud on the front of the head; it will hit the steering shaft after install.

Engine mounts

- 🛠 Engine mounts, Engine mount spacers, M10 x 25mm bolts, $\frac{3}{8}$ " x 1.50" carriage bolts
- 🔧 $\frac{9}{16}$ ", 17mm sockets, ratchet, hammer.

Use a $\frac{9}{16}$ " socket and ratchet to remove the three locknuts on each of the engine mounts and save them. Use a hammer to remove the three carriage bolts from the bottom engine mount plates. They are not used again.

ITEM NO.	PART NUMBER	DESCRIPTION	QTY.
1	4.6L left side top mount		1
2	4.6L left side bottom mount		1
3	16249	COYOTE ENGINE MOUNT 2 HOLE SPACER	1
4	16250	COYOTE ENGINE MOUNT 1 HOLE SPACER	1
5	16251	COYOTE ENGINE MOUNT 3 HOLE SPACER	1
6	RHSSNBOLT 0.375-16x1.5x1-N		3
7	13964	NYLON INSERT LOCKNUT, 3/8-16 UNC	3
8	AM-M14-N		1

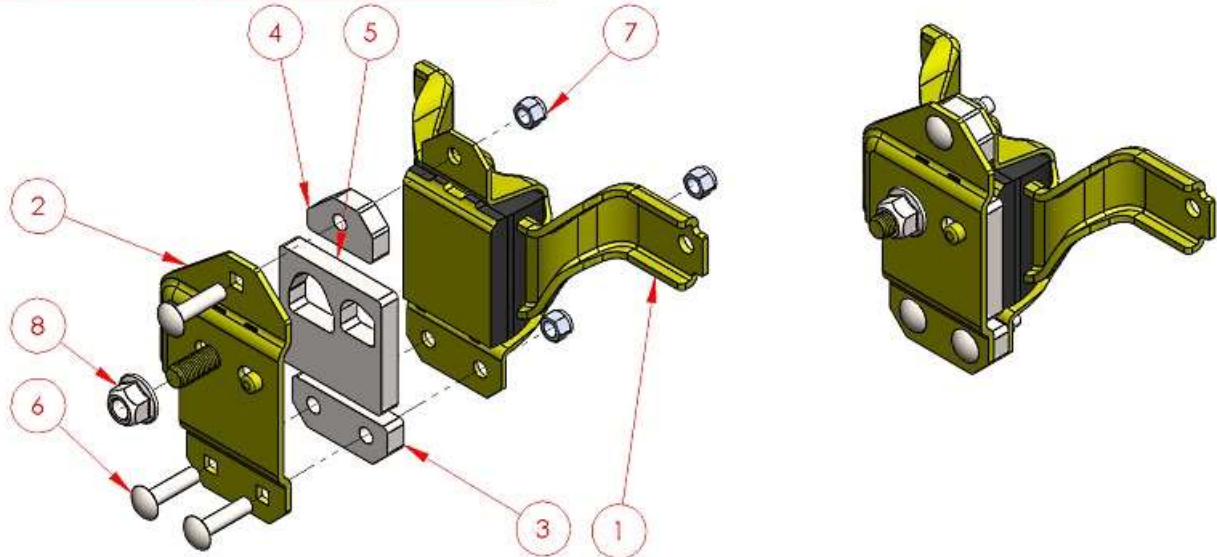

Reassemble the left engine mount using the 1/2" thick spacers, 3/8" x 1.50" carriage bolts and a 9/16" socket with ratchet. Reuse the 3/8" locknuts.

ITEM NO.	PART NUMBER	DESCRIPTION	QTY.
1	16249	COYOTE ENGINE MOUNT 2 HOLE SPACER	1
2	16250	COYOTE ENGINE MOUNT 1 HOLE SPACER	1
3	16251	COYOTE ENGINE MOUNT LARGE SPACER	1
4	4.6L right side bottom mount		1
5	4.6L right side top mount		1
6	AM-M14-N		1
7	RHSNBOLT 0.375-16x1.5x1-N	16264	3
8	13964	NYLON INSERT LOCKNUT, 3/8-16 UNC	3

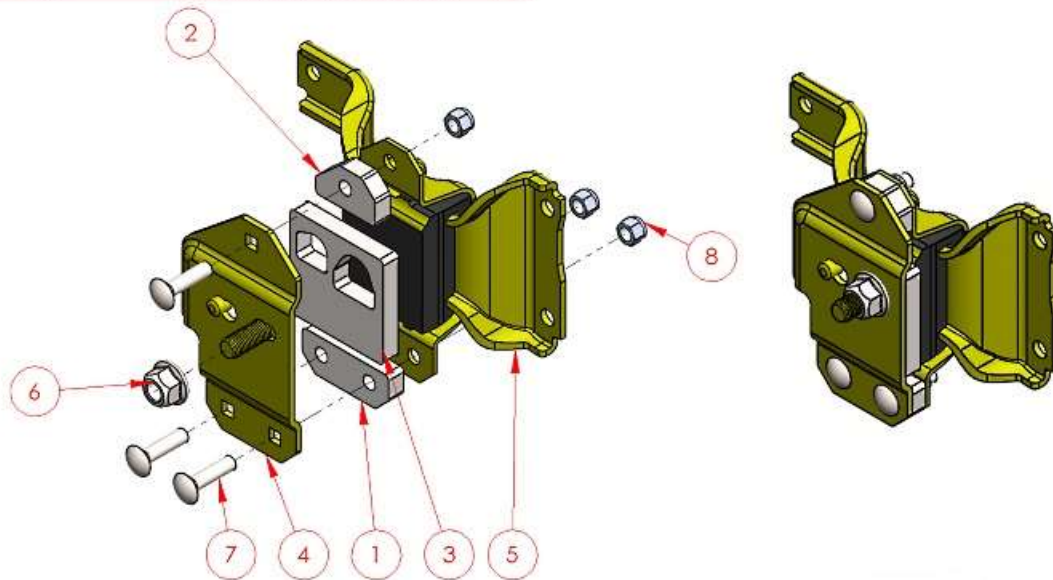

Reassemble the left engine mount using the 1/2" thick spacers, 3/8" x 1.50" carriage bolts and a 9/16" socket with ratchet. Reuse the 3/8" locknuts.

Attach the engine mounts to the engine using the M10 x 25mm bolts provided with the engine mounts and a 17mm socket with ratchet.

Oil Pressure sender

- 🛠 Pipe fittings, Gauge assembly
- 🔧 H14 Hex key, 12mm deep, $\frac{13}{16}$ " , $1\frac{1}{16}$ " sockets, ratchet, Teflon tape, ratchet extensions, $\frac{3}{8}$ " , (2) $\frac{9}{16}$ " , $\frac{11}{16}$ " , $\frac{7}{8}$ " wrenches, vise grips
- 👤 Autometer gauge sender shown, similar install for Vintage gauge sender.

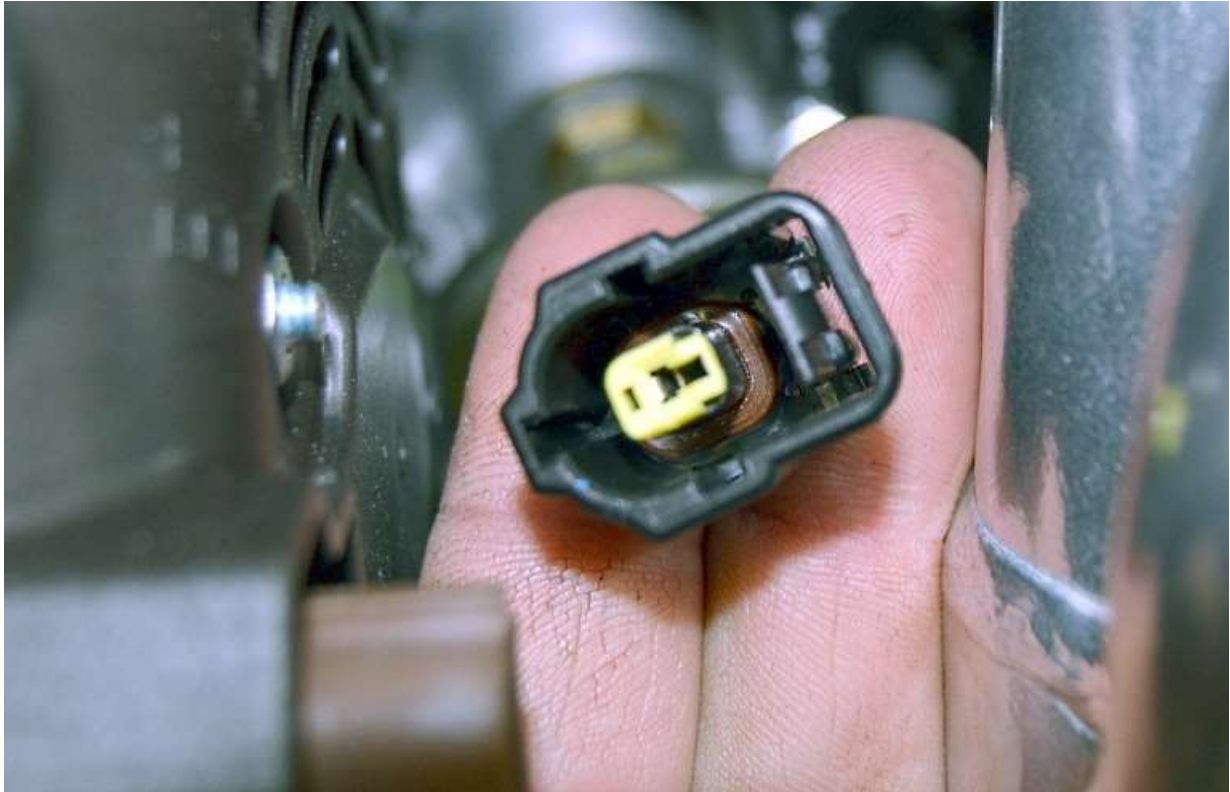

Remove the stock oil pressure gauge sender plug from the block located on the left front side of the engine. This plug will not be used again



Remove the stock oil pressure gauge sender from the block located behind the alternator. This Sending unit will not be used again.



Use Teflon tape and install the oil pressure gauge sender.



From the gauge box, screw on the 1/4" NPT adapter.

Screw the Sending unit into the block.

Water Temp Sender

- ✂ H14 Hex key or socket, 1¹/₁₆" socket, 12mm deep socket, extension, ratchet, Teflon tape
- 🔧 Water temp gauge sending unit.
- 👤 Autometer gauge sender shown, similar install for Vintage gauge sender.

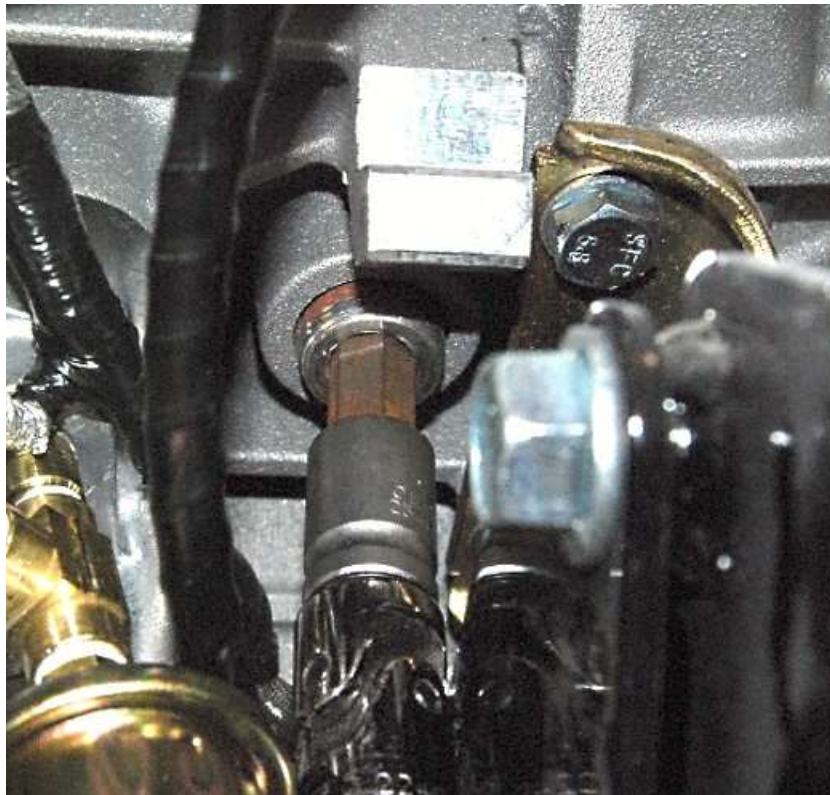

Remove the $\frac{3}{4}$ " NPT plug from the side of the block using a H14 Hex key or socket.



Put Teflon tape on the $\frac{3}{4}$ " NPT to $\frac{1}{2}$ " NPT adapter.

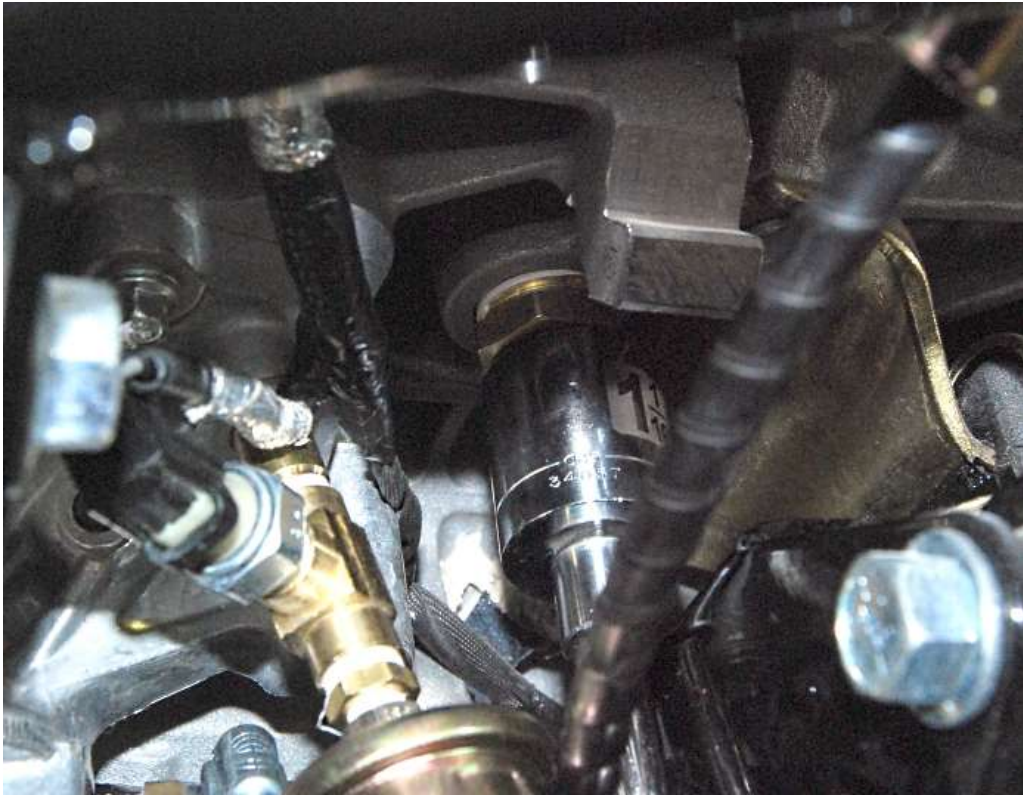

Screw the adapter into the block using a 1 1/16" socket.



Use Teflon tape on the 1/8" NPT to 1/2" NPT adapter included with the gauge.



Screw the adapter into the larger adapter on the block.



Put Teflon tape on the sending unit.



Use a 12mm deep socket to screw the sender into the adapters.

Transmission Prep

- ✂ Hack saw or Reciprocating saw, 3/4" socket, ratchet
- 🚗 Transmission, Polyurethane engine/transmission mount kit
- 🧤 The two aluminum spacers provides are not used.



If you are using a Tremec 3550, TKO 500 or, a TKO 600 you will need to trim off the unused mounting boss on the bottom of the case.



Trim it flush or just below the pad for the transmission mount.

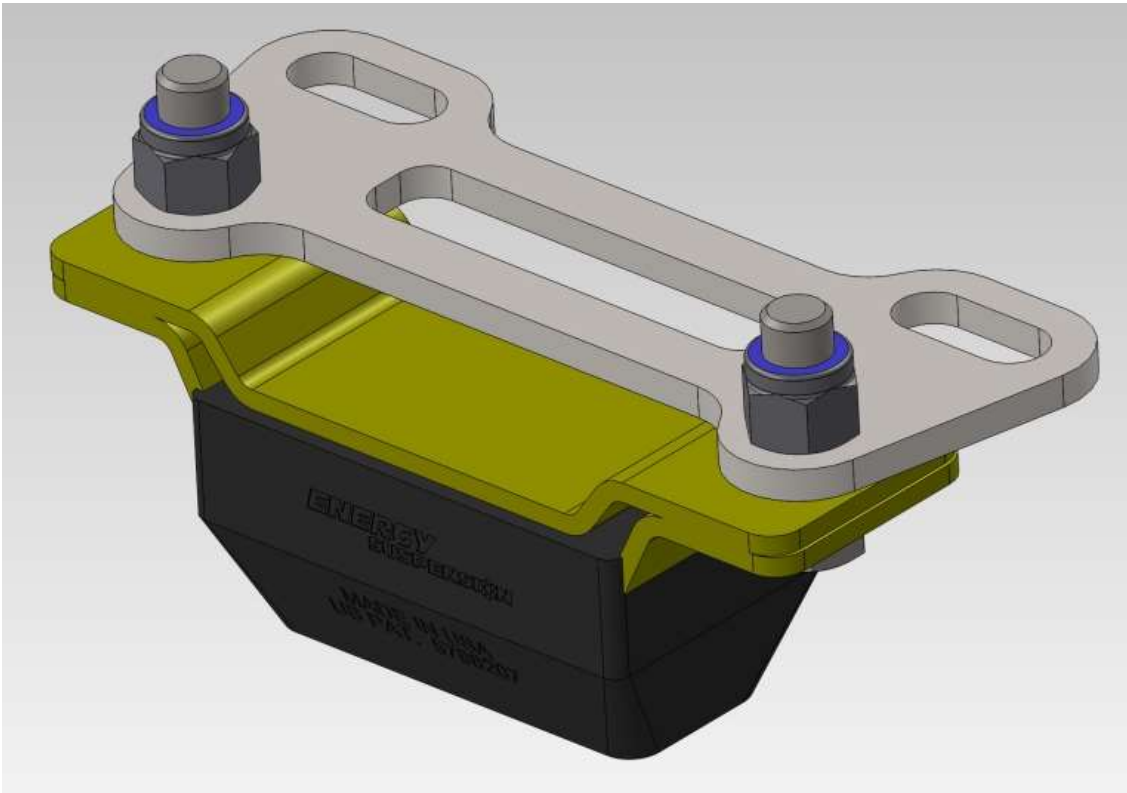

Attach the transmission mount plate to the polyurethane transmission mount using the ½"-13 x 1.50" bolts.

If not already done, install the flywheel and clutch on the engine.



Remove the vibration damping weight from the clutch fork, it is not needed.

Attach the bellhousing and clutch fork to the engine.

Attach the transmission to the engine.

Engine/Transmission Installation

Install the engine and transmission per the assembly manual.





The engine will sit low in the engine mounts.



Attach the polyurethane transmission mount assembly to the transmission.

Attach the polyurethane transmission mount to the frame mount.

Fuel System

-  Fuel pressure regulator, fittings, fuel hose, hose clamps, high pressure fuel pump
-  The Coyote engine requires a 255 lph high pressure fuel pump such as the Summit Racing SUM-G3138 Fuel Pump. Either an inline pump or in-tank pump can be used depending on preference.

Fuel pressure regulator



Mount a fuel pressure regulator to the firewall and connect the appropriate fittings, the return is on the bottom.

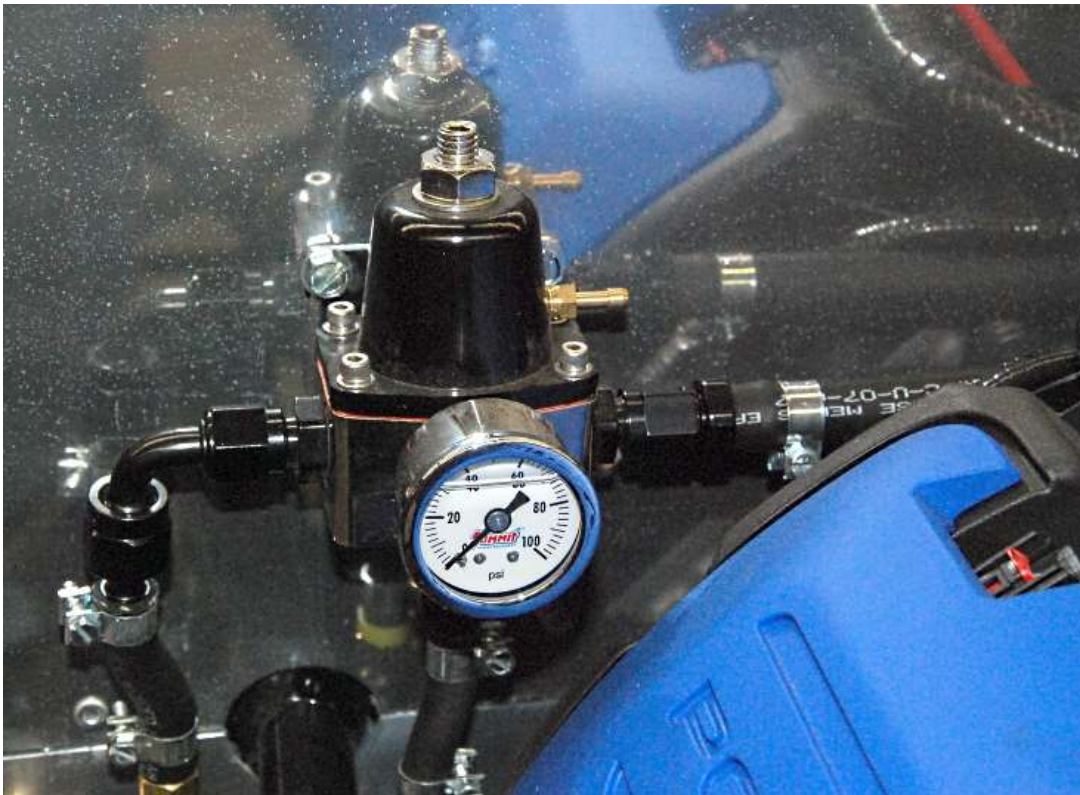

Push the $\frac{3}{8}$ " fuel line onto the right side of the regulator then attach a hose clamp and run it over to the engine fuel rail.

Fuel lines

Push the white fuel line connector onto the fuel rail.

Hold the fuel line up to the connector and cut it to length with a razor knife.

Remove the fuel line connector.

Slide a hose clamp onto the hose then push the fuel line connector into the hose and tighten the clamp.



Push the white connector onto the fuel rail.

Fuel pressure regulator vacuum

Cut a 2.50" section from the length of 1/2" hose provided.

Assemble the 1/2" to 5/32" 90 degree adapter.

Push the 1/2" side into the short section of 1/2" hose and fasten with a hose clamp.

Slide a second hose clamp onto the hose.

Push the vacuum line onto the hose adapter.



Push the ½" hose onto the vacuum port on the right side of the throttle body so the small end points towards the firewall and tighten the hose clamp.



Run the vacuum line to the fuel pressure regulator and push it onto vacuum barb.

Cooling system

- ✂ Razor knife, flat head screwdriver, wire cutters, hack saw, marker
- 🔧 Stainless radiator hose kit



Push the correct size adapters onto to the thermostat housing with a length of the stainless hose.

Route the stainless hose to the left side lower radiator outlet and mark the hose for cutting.
Remove the stainless hose and cut it where marked with a hack saw.
Reinstall the hose.



Push the Ford supplied hose onto the outlet under the throttle body.



Decide where you would like to change to the stainless hose and cut the webbing off the hose using wire cutters.

Cut the hose using a razor knife.



Push the stainless hose into the end of the rubber hose and run the hose to the right side upper radiator inlet.



Push the bypass caps onto the tubes to the left of the throttle body and hose clamp the lower one.

- ✎ For air bleeding later, remove the top cap until coolant starts going up the tube then recap and hose clamp.
- ✎ This top one is one of the heater core hose locations if running a heater.



Push and hose clamp the small coolant barb behind the 3/4" coolant tubes.



Cap and hose clamp the 3/4" coolant.



This is the other heater core location if running a heater.

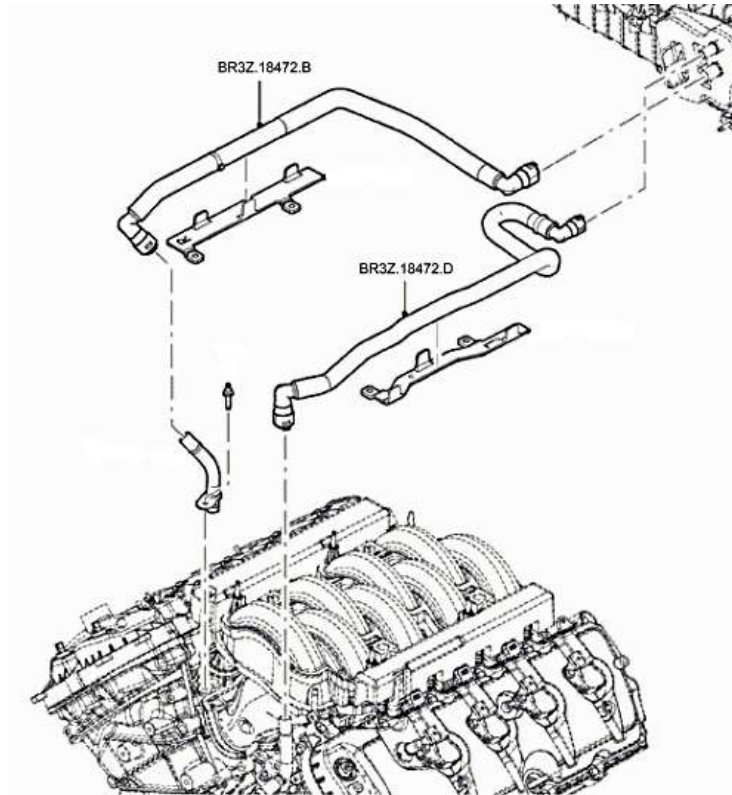

If running a heater, the stock Mustang heater hoses work well. The numbers for the hoses are:

BR3Z.18472.B

BR3Z.18472.D





Vacuum ports and PCV vent

- ✂ Flat head screwdriver, razor knife, WD40
- 🔧 Vacuum plugs, PCV lines, ½" rubber hose, T connector
- 👤 There are a couple ways to route the PCV hose depending on your emission requirements (tough or relaxed)



Block off the vacuum ports and fuel evaporator intake tube just behind the throttle body.

Tough emissions



If not already done, connect the right side stock PCV hose from the valve cover to behind the throttle body. Install a ½" barb fitting in the intake tube after the mass air meter but before the throttle body.



Carefully cut the 90° PCV fittings out of one of the pcv lines without damaging the barbs.

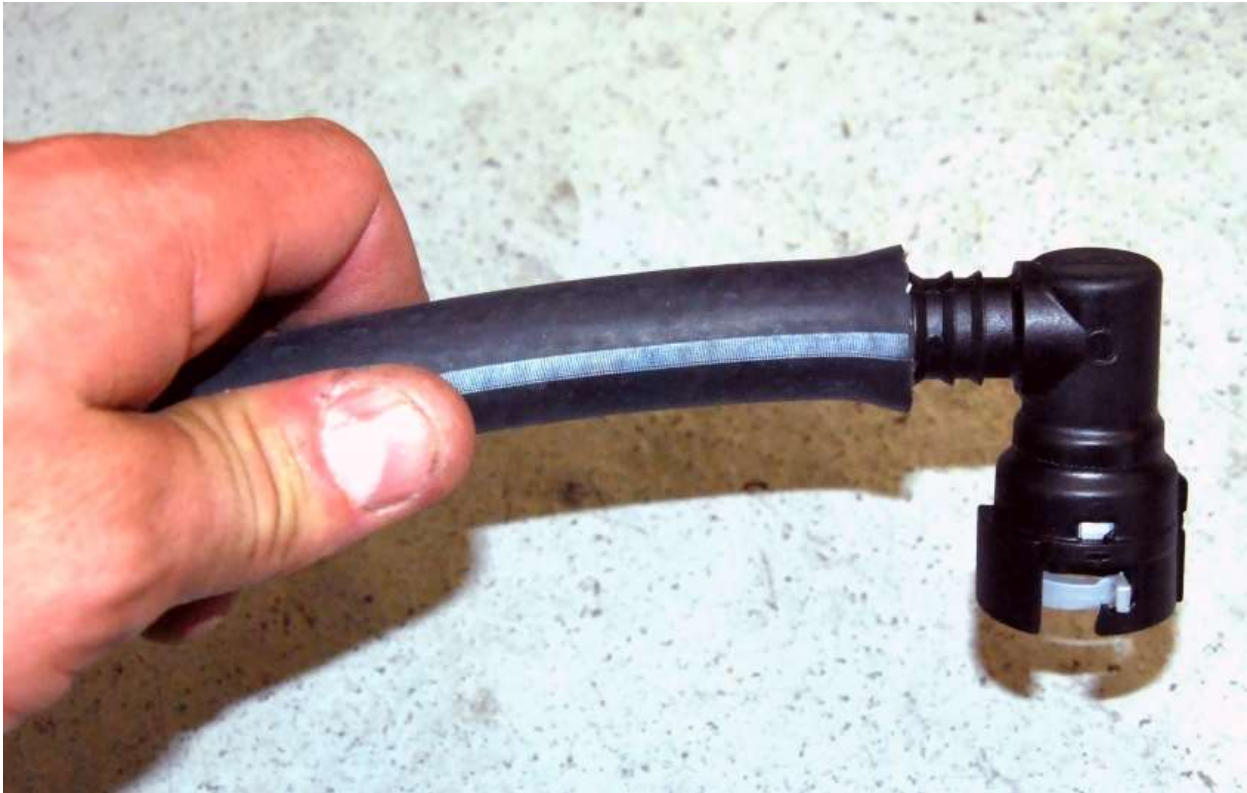

Push the ½” heater hose onto the PCV fitting.



Attach the fitting to the left side valve cover.

Run the hose over to the intake barb and cut the hose to length.
Use a hose clamp to attach the hose to the intake tube.

Relaxed Emissions



Carefully cut the 90° PCV fittings off the pcv lines without damaging the barbs.



Spray some WD40 into the end of the hose and push the ½" heater hose onto one of the PCV fittings.



Push the fitting onto the left valve cover and run the hose the back of the engine.

Cut the hose at the back of the engine with a razor knife.

Push the remaining hose onto the other 90° PCV fitting again using WD40.



Push the fitting onto the right valve cover and run the hose around the back of the engine to the left side.



Insert the “T” fitting into left side hose.
Cut the Right side hose so that it will go onto the “T”.
Push the right side hose onto the “T”.



Push the remainder of the hose onto the third leg of the “T” and run it down the side of the bellhousing and zip tie it to the transmission tunnel tube.

Air Intake

Mass Air Meter

-  Mass air meter, silicone hoses, intake tubes, air filter
-  T-20 Torx driver, Flat head screwdriver, Philips head screwdriver, sensor safe RTV silicone
-  These instructions show the Spectre parts. For the Treadstone MAF tube, make sure the Mass Air meter is pointed in the correct direction.



Unscrew the mass air sensor from the Ford intake using a T-20 Torx driver



Remove the sensor and note the direction of the curved part of the sensor.



Install the rubber ring into the intake mount.

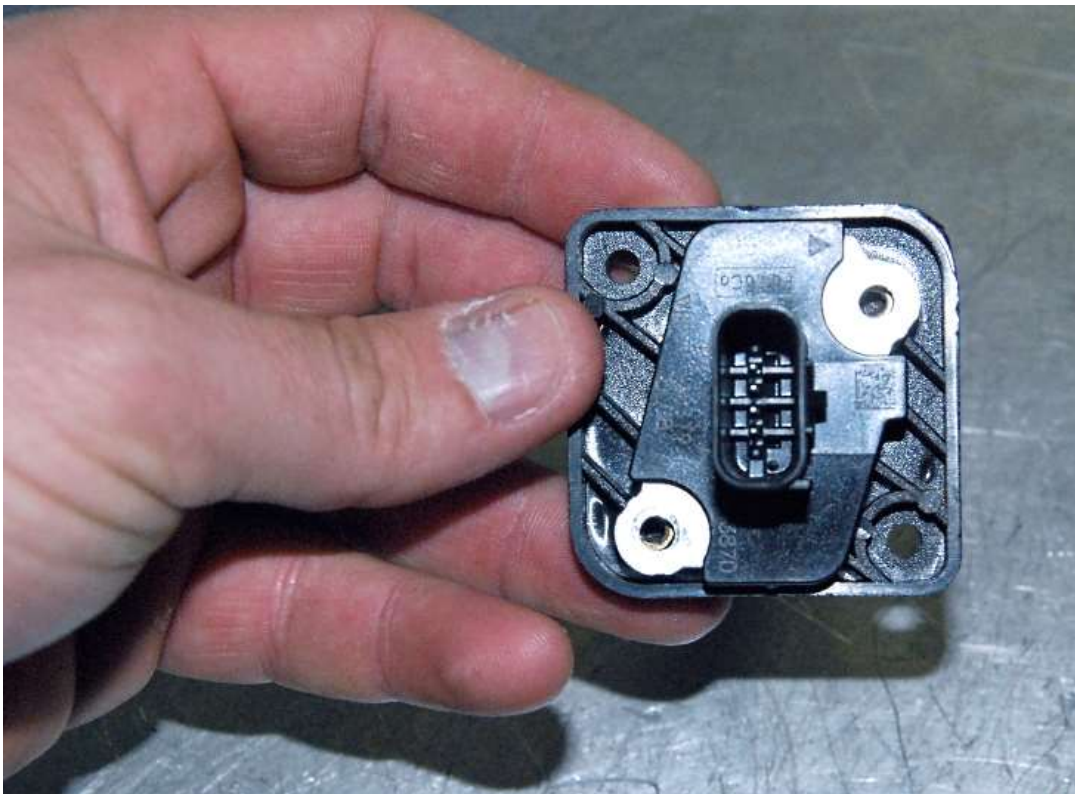

Insert the sensor into the mount to determine which way around it needs to go so the sensor mount holes will line up and the sensor will mount the correct way.



Attach the mount to the intake tube using the long screws so that the flat side of the sensor will face the “Spectre” writing.

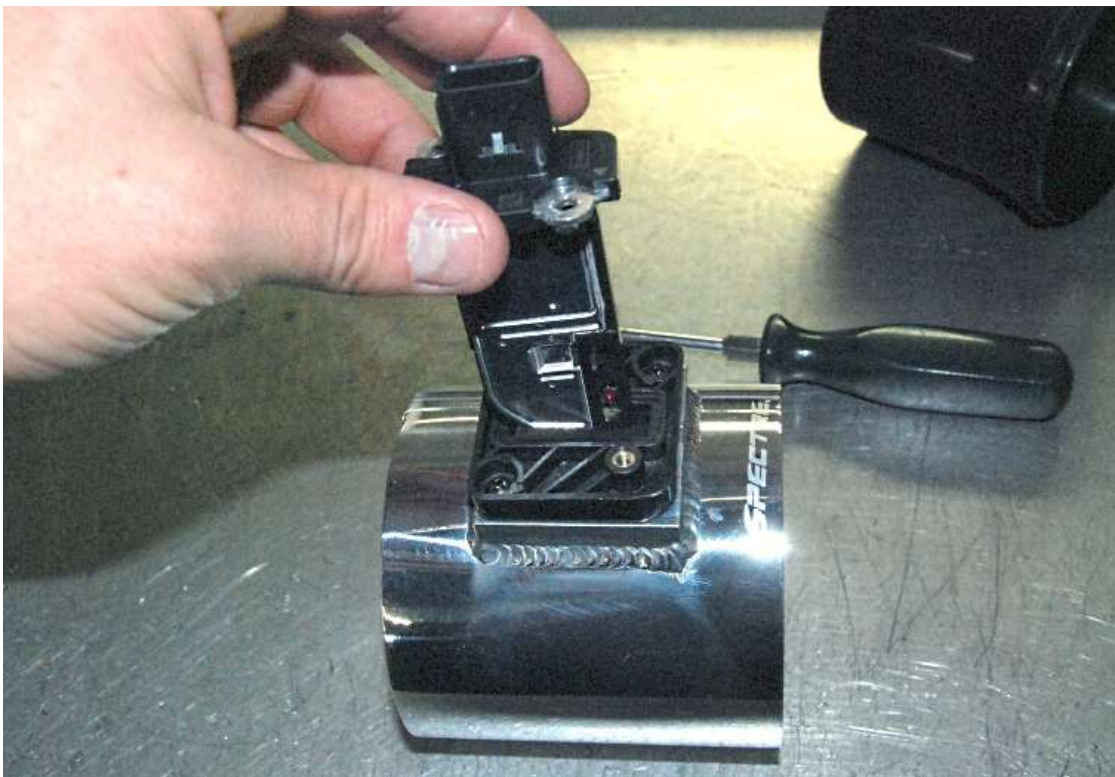

Install the sensor on the mount using the short screws so the flat side of the sensor will face the “Spectre” writing.



Run a bead of Sensor safe RTV silicone around the flange of the large plastic reducer.



Slide the Mass Air Meter tube flat sensor side first (Spectre writing) down onto the plastic reducer.

Wipe any excess RTV off the tube.



Turn the mass air meter over so the Reducer is on the top and let the RTV dry overnight.

Intake tube

SPECTRE MAF SENSOR



Slide the Mass Air Meter tube flat sensor side first (Spectre writing) into the air filter.



Adjust the Mass air meter so that the mass air plug is on the far side as the Ford Racing instructions recommend.



Tighten the hose clamp.

Connect the elbow tube to the mass air meter using the silicone connector; only tighten one of the hose clamps right now.

Attach the silicone reducer to the tube elbow.
Push the intake tube onto the throttle body and position the air filter under the hood hinge.
Tighten the hose clamps.



TREADSTONE MAF SENSOR

👉 Make sure the Mass Air meter is pointed in the correct direction.



Push the FFR filter onto the Mass Air meter making sure that the meter is facing the correct direction.

Slide hose clamps onto the 90° Silicone hose.



Test fit the 90° Silicone hose on the mass air meter and the throttle body, if necessary cut the legs of the hose for radiator and frame clearance.

Adjust the Mass air meter so that the mass air plug is on the far side as the Ford Racing instructions recommend.

Tighten the hose clamps



Push the mass air plug onto the mass air meter.

Wiring

✂ Soldering iron, solder, electrical tape, wire cutters, wire strippers

Speed Dial – 2011-2014



- 👤 The speed dial is only needed for 2011-2014 Coyote Control packs. If running a 2015 or newer, skip this section.
- 👤 Solder all connections
- 👤 Use shrink wrap.
- 👤 By adding the Speed Dial, the ECM uses this signal to determine if the vehicle is in motion and uses that data to determine the correct idle characteristics during extended coasting to a stop.
- 👤 If M-6017-A504VA control pack was ordered, the pins are already in this harness.
- 🔧 M-4209ADPT-A Speed Dial, Shrink wrap, Screws or double stick tape (for mounting)
- ✂️ Wire cutter, Wire stripper, Soldering iron, Electrical tape, Philips head screwdriver, Small Flathead screwdriver, Razor knife



Remove the cover to the speed dial.

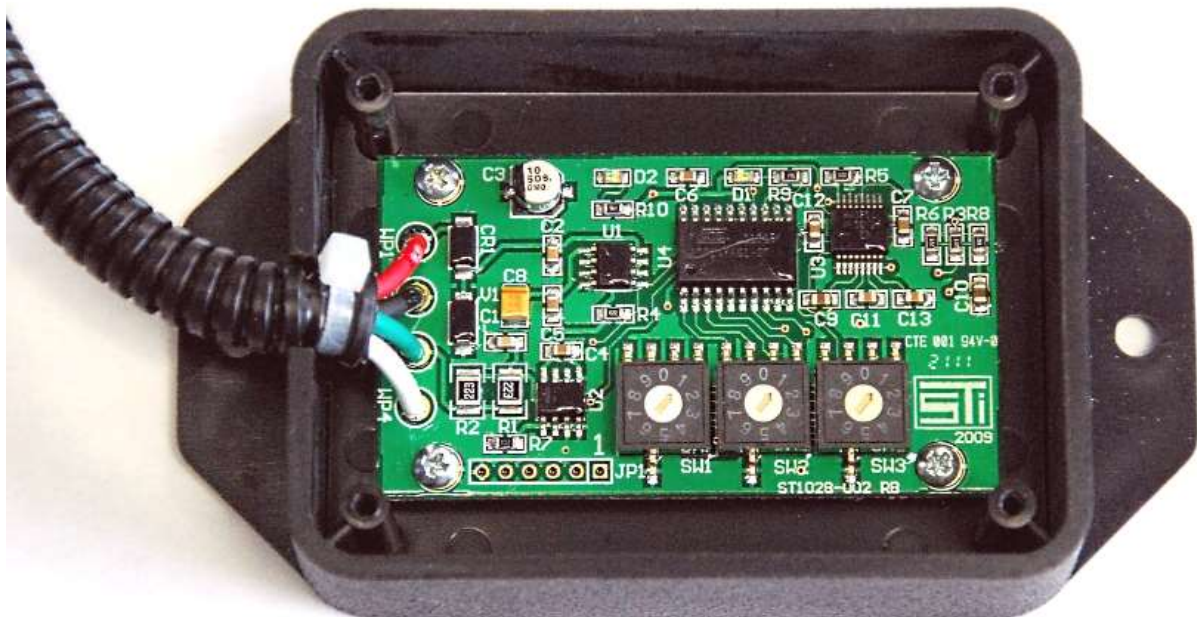

Set the dip switches to 111

Locate a place to mount the Speed Dial.



If using double stick tape, attach it now.



Attach the Speed dial to the desired mount area.

SPEED DIAL CONNECTIONS

Slide shrink wrap onto the Speed Dial wires then solder the same color wires from the control pack together and shrink the shrink wrap onto the connection.

Harness install

✎ Use the diagram at the beginning of these instructions for general routing and component location.

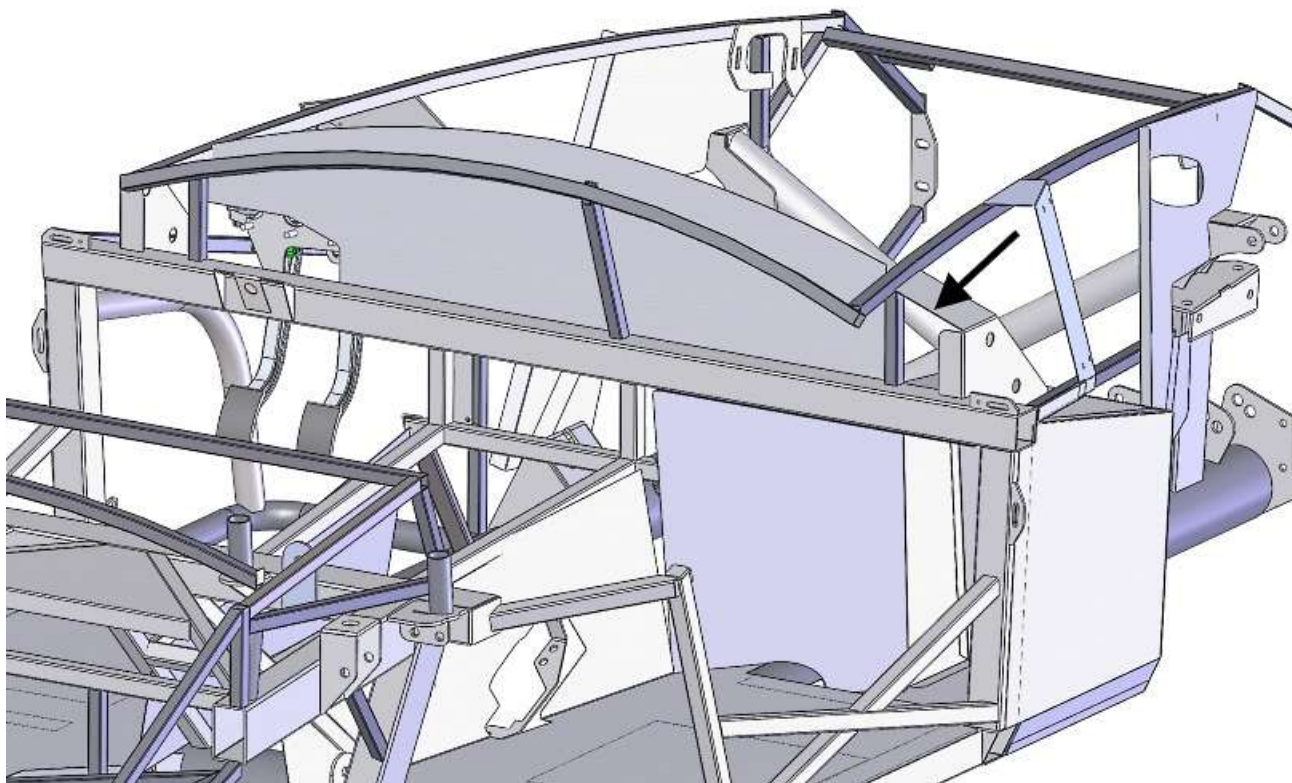

Lay the Control pack harness out on the chassis according to the diagram for the year engine being used with the harness going into the engine bay through the firewall extension opening

COMPUTER MOUNTING

2011-14

✎ Silicone, Drill, tin snips

Measure and find a location for the computer.



If you are running a heater, using the $\frac{3}{4}$ " tube over the passenger footbox is a good place to mount a bracket.



We located it in the firewall on the passenger side.



If you are running a heater or wipers you cannot do this location.

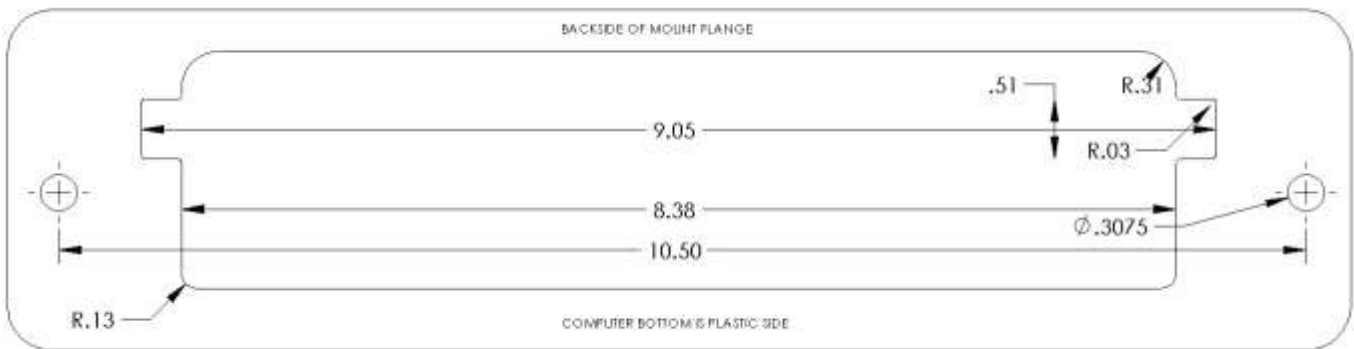

This diagram can be scaled on a copier to create a template. Measurements are in inches.



Use weatherstripping or silicone around the flange of the computer to seal the hole.

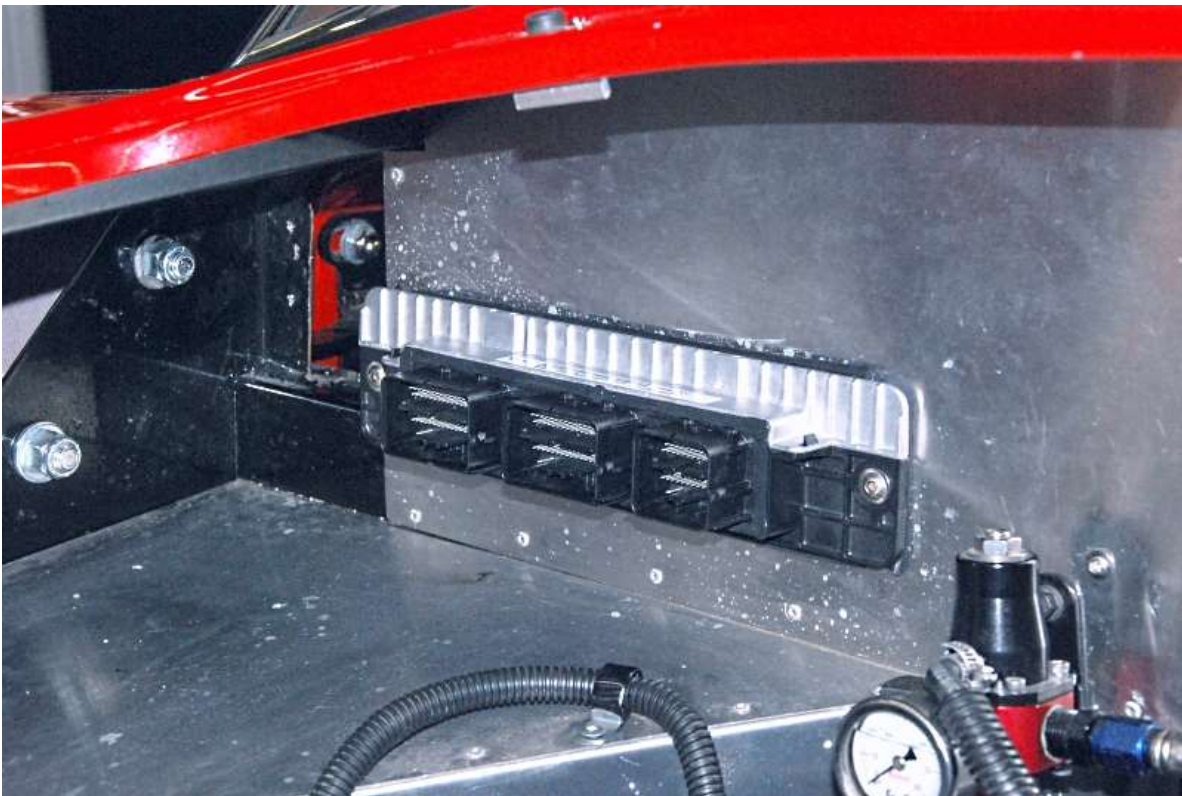

Mount the computer to the car using the #10 x 1" screws in the wiring harness mounting hardware or nutserts if you have them.

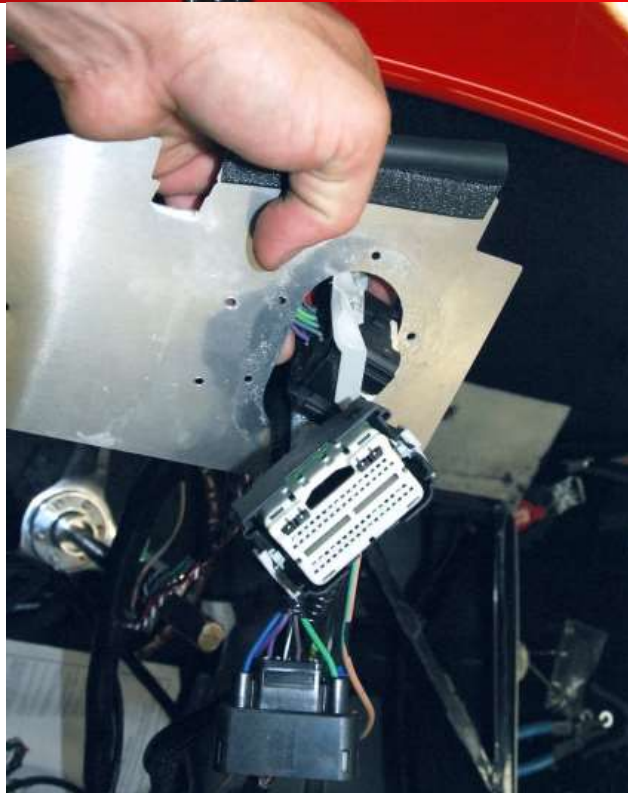

Pass the O₂ harness, computer plugs and other wires in the engine harness through the firewall extension hole into the engine bay.

Drill a hole the size of the harness in the oval block off cover for the firewall extension.
From the side, cut across to the hole and slide the block off onto the harness.



Use some grommeting from the misc. electrical components to protect the harness.

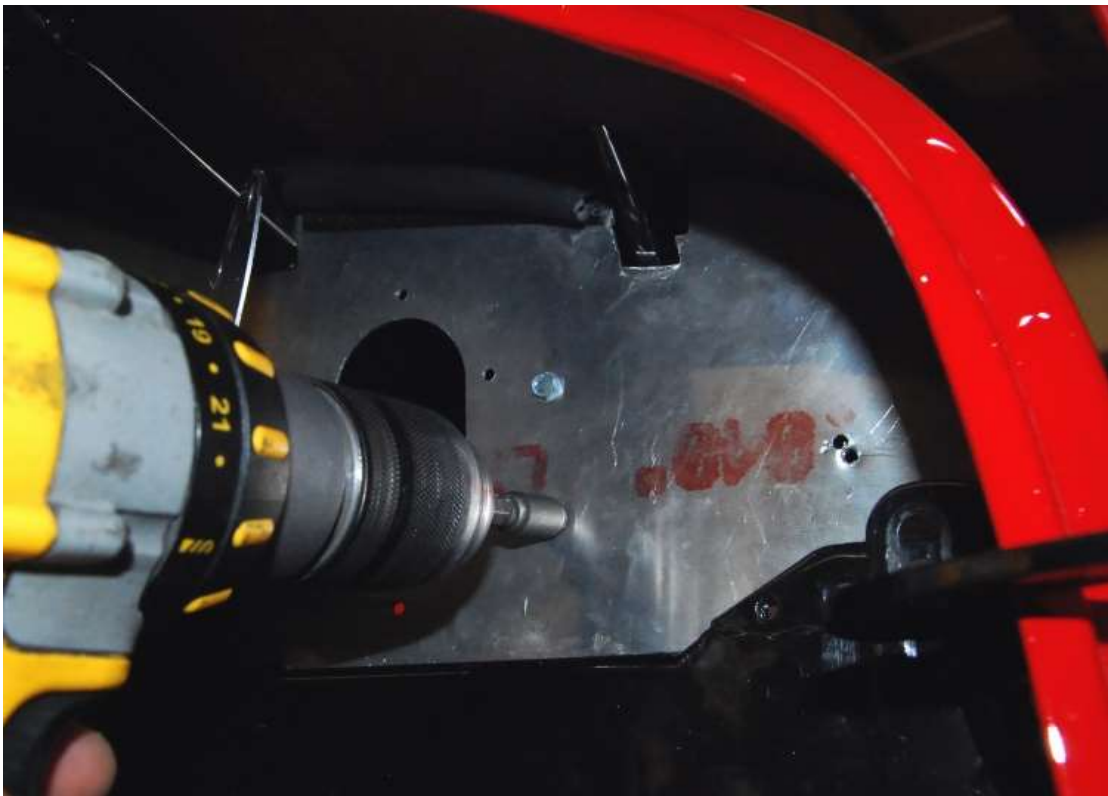

Attach the firewall extension to the frame.



Silicone and rivet the block-off cover to the firewall extension.

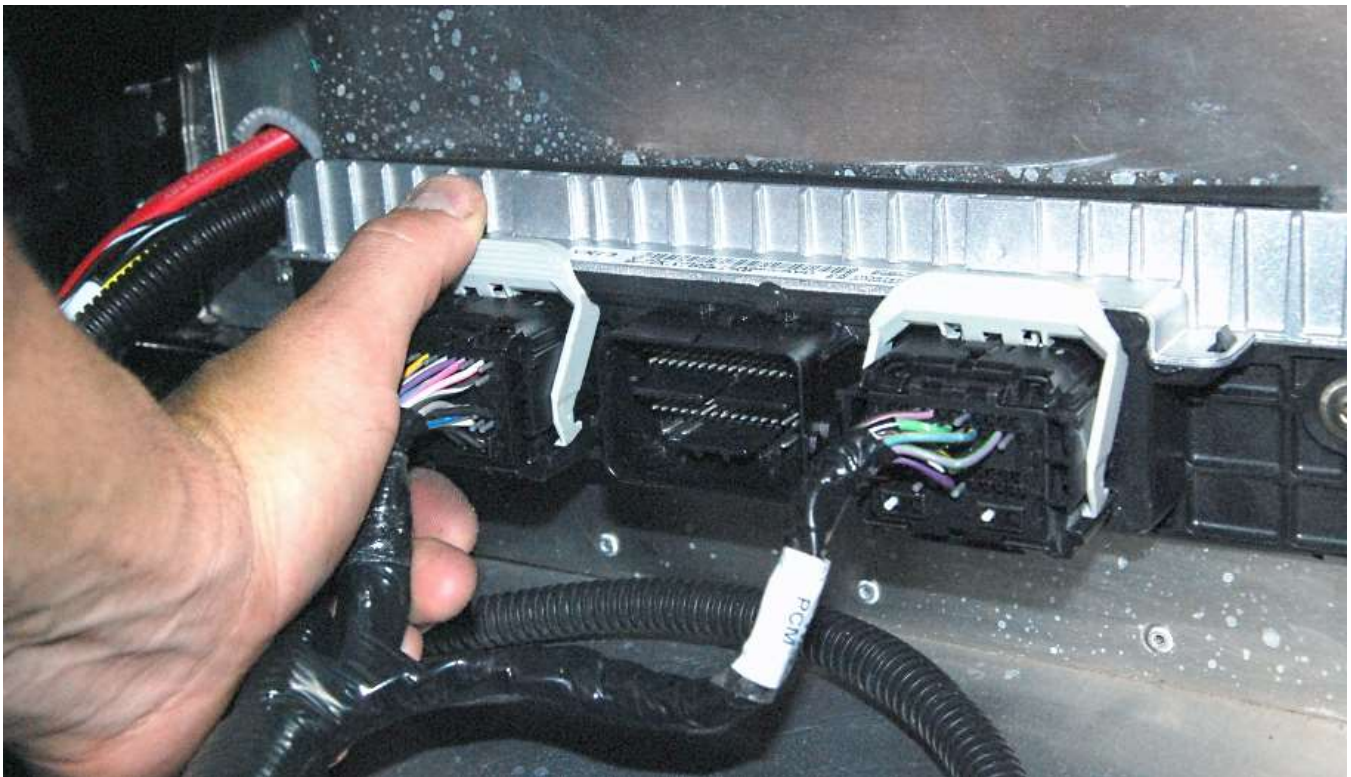

Plug the two engine harness plugs into the computer.

2015 & newer

- ☞ Aluminum computer mounting bracket, $\frac{3}{16}$ " rivets
- ✂ Drill, $\frac{1}{4}$ " driver bit, $\frac{3}{16}$ " drill bit, rivet tool, $\frac{1}{2}$ " wrench, ratchet, $\frac{1}{2}$ " socket.



Locate the aluminum computer bracket so that it spans between the upper and lower $\frac{3}{4}$ " tubes that go down to the front suspension on the right side of the chassis and the rear bottom computer hole lines up with the front of the right footbox.

Drill and rivet the bracket to the frame using the $\frac{3}{16}$ " rivets provided.

Attach the computer to the bracket using the $\frac{5}{16}$ " x 1.25" bolts and nuts provided along with a $\frac{1}{2}$ " wrench, ratchet, $\frac{1}{2}$ " socket.

Connect the Engine harness plug and the Control pack plugs to the computer.



Connect the Engine harness plug to the control pack plug.

2015 & NEWER ROUTING



Route the BB harness (harness leg with the alternator and Mass air plugs at the end) to the front of the engine and run it across to the engine with the engine harness. Loosely zip tie the harnesses together.



Run the BB harness leg to the back of the engine and across the back.



Run the BB harness leg back to the front of the engine on the left side.



Plug the mass air meter connector into the mass air meter.



Run the alternator plug down to the alternator.

Loosely zip tie the harnesses together going around the engine.

Fuel Pump

- 👉 2011-14 - the fuel pump wire is in the Ford Performance 15 pin connector
- 👉 2015 & newer - the fuel pump wire is in the Ford Performance 16 pin connector.



Remove the fuse from the fuel pump circuit on the chassis harness fuse panel.

Route the Coyote harness fuel pump green wire to the back of the chassis harness fuel panel.



Disconnect the fuel pump wire at the relay.

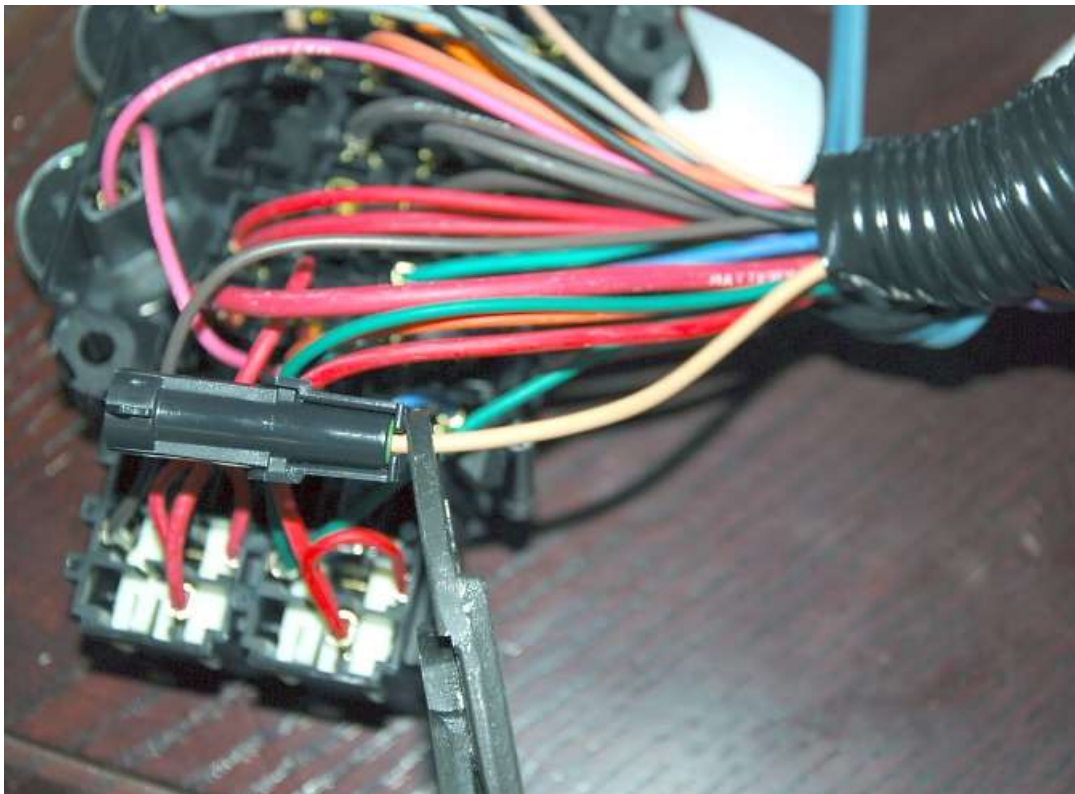

Cut the connector off the tan wire going into the harness



Solder and tape the tan wire and Fuel pump relay out (green) wires together.

Make sure the wires and harness are out of the way of the steering shaft.

Neutral Safety switch

👉 2011-14 Only

If not using the neutral safety switch in the Coyote harness, route the wire (blue/yellow) to a ground on the chassis.

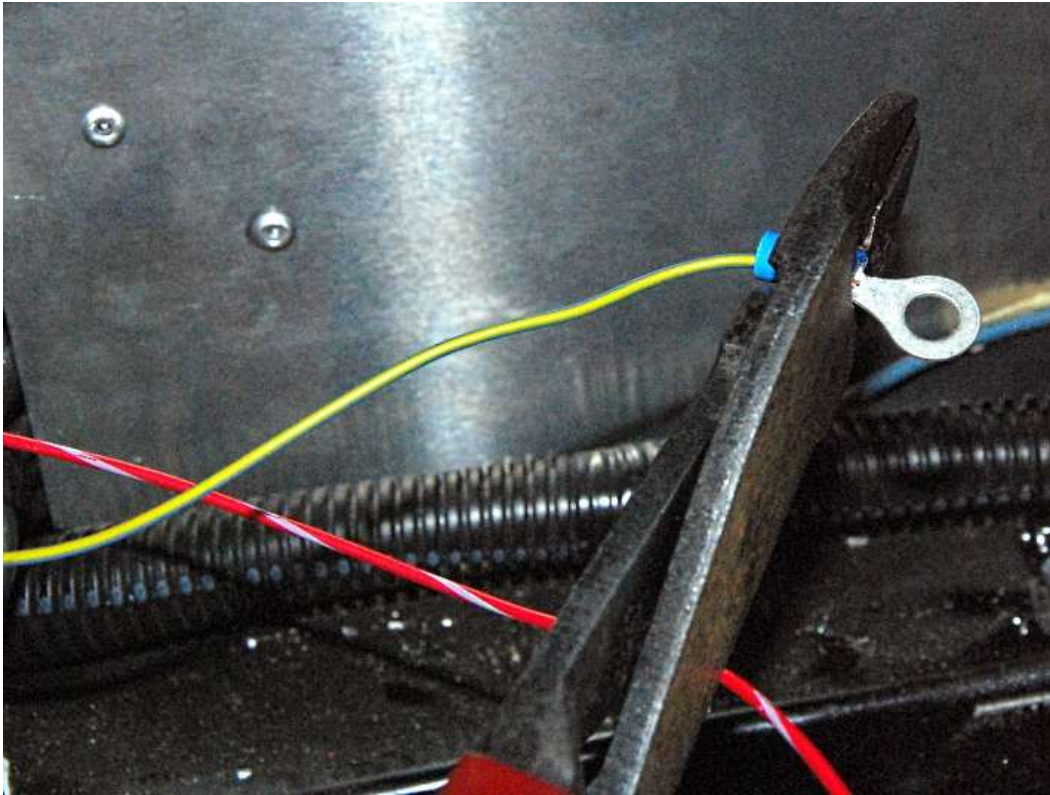

Cut the wire to length and crimp on a blue ring connector.



Attach the ring connector to ground.

Clutch position switches

👉 2015 & Newer only



Ford Performance bottom and top travel switches, coyote clutch switch components.

1/4" nut driver, 1/2", 9/16" wrench, 1/4", 1/2" socket, Ratchet, 3/16", 5/16" hex keys.

The install is shown outside the footbox for better pictures.

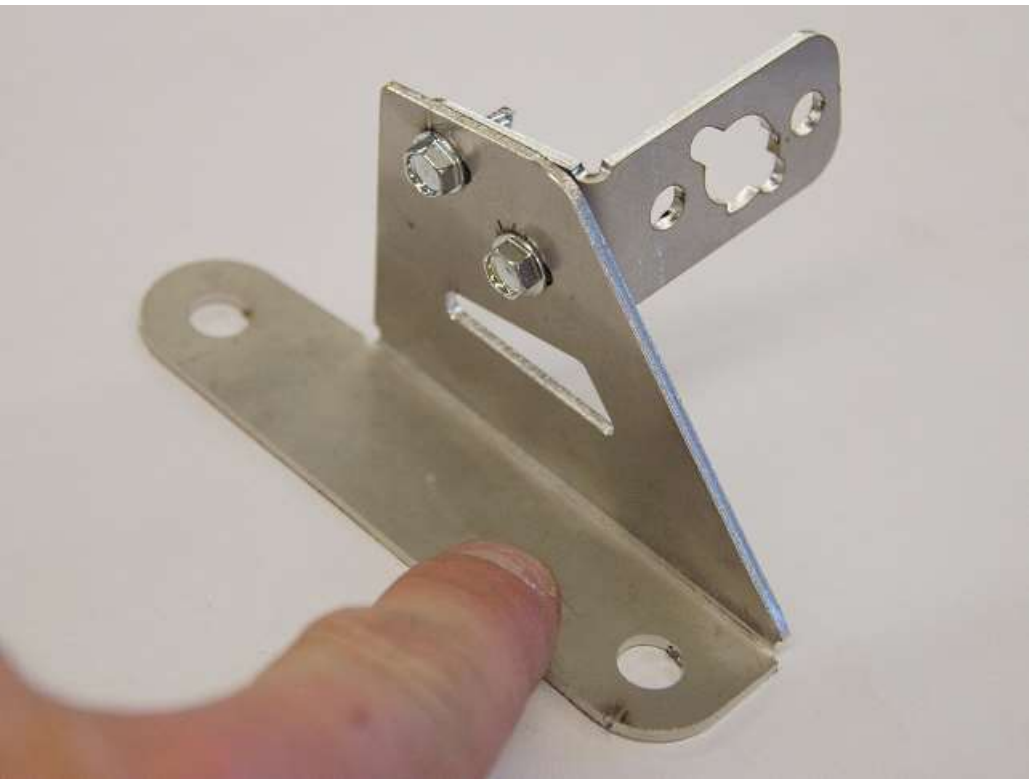

Hold the clutch pedal switch mount in a vise and screw the top travel switch mount to it using the #8 self-tapping screws and 1/4" nut driver. Leave the screws loose enough so that the switch mount can slide in the slots.

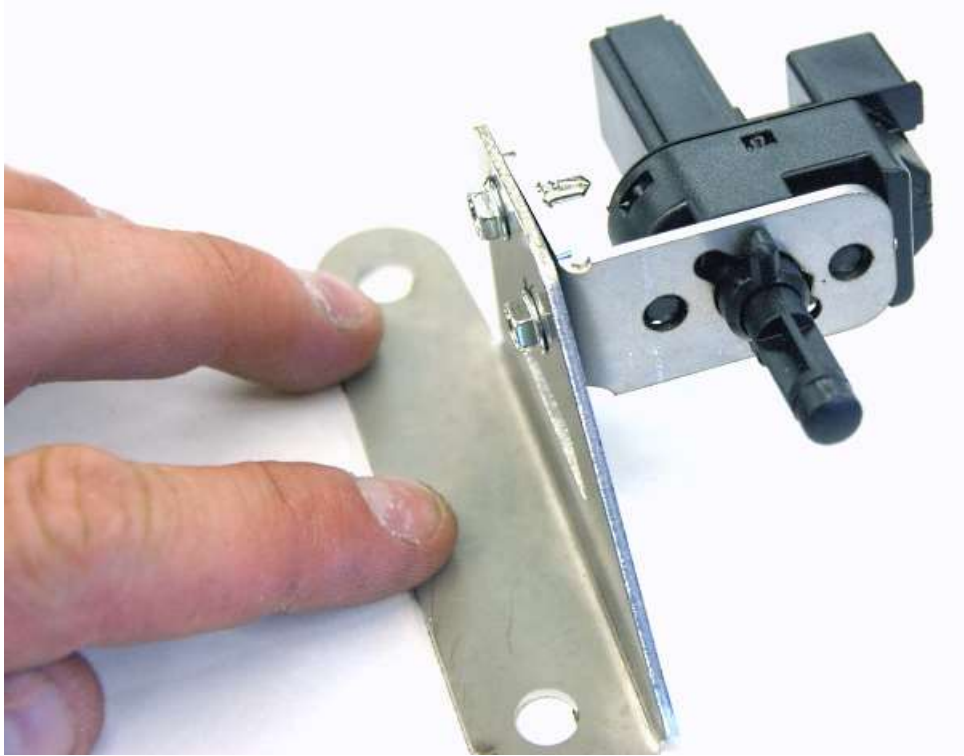

Insert the Top travel (black plunger) clutch switch into the bracket and turn it to the position shown to lock it into place.

Remove the clutch cable from the quadrant.

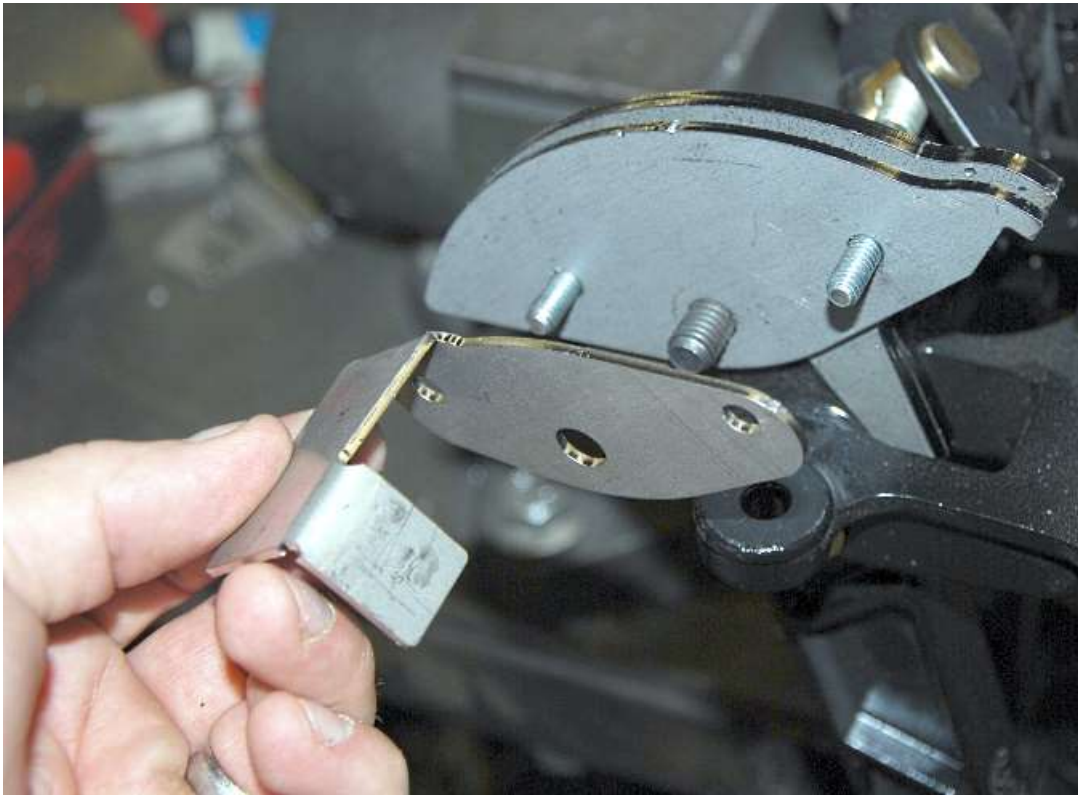

On the clutch pedal, remove the last $\frac{1}{8}$ " clutch quadrant end plate and replace it with the stainless bottom switch clutch quadrant plate.

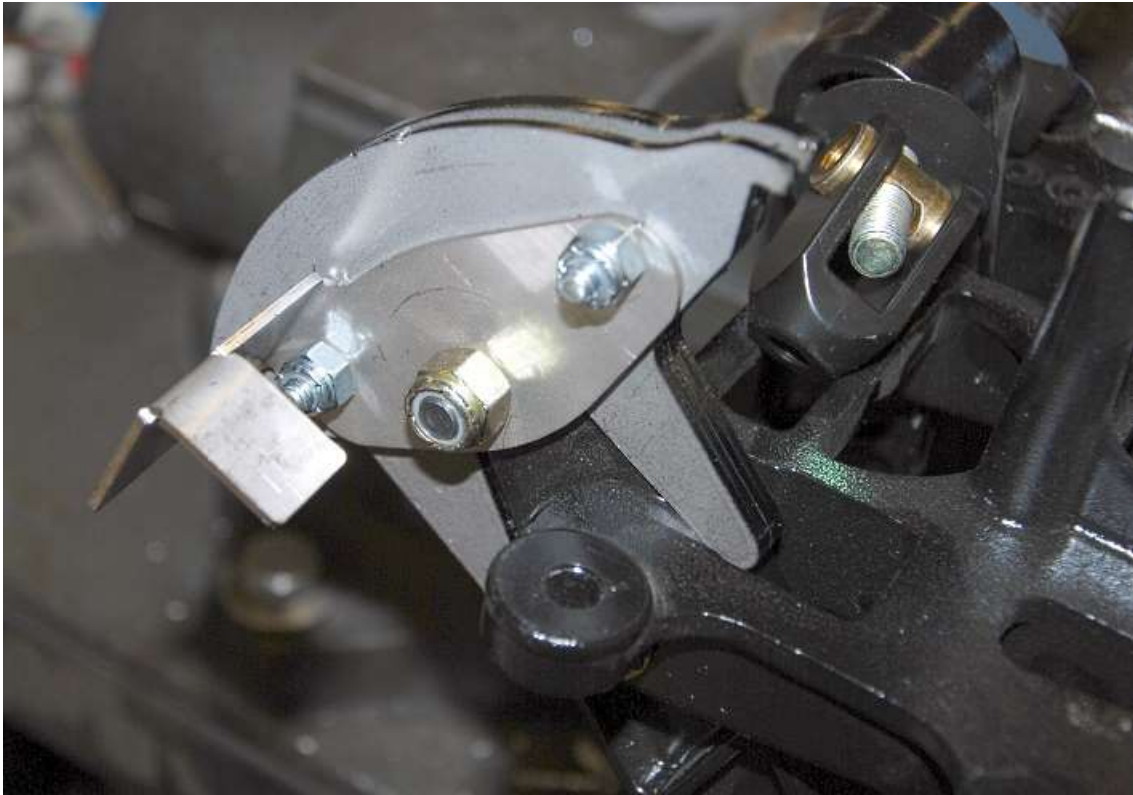

Tighten the locknuts.

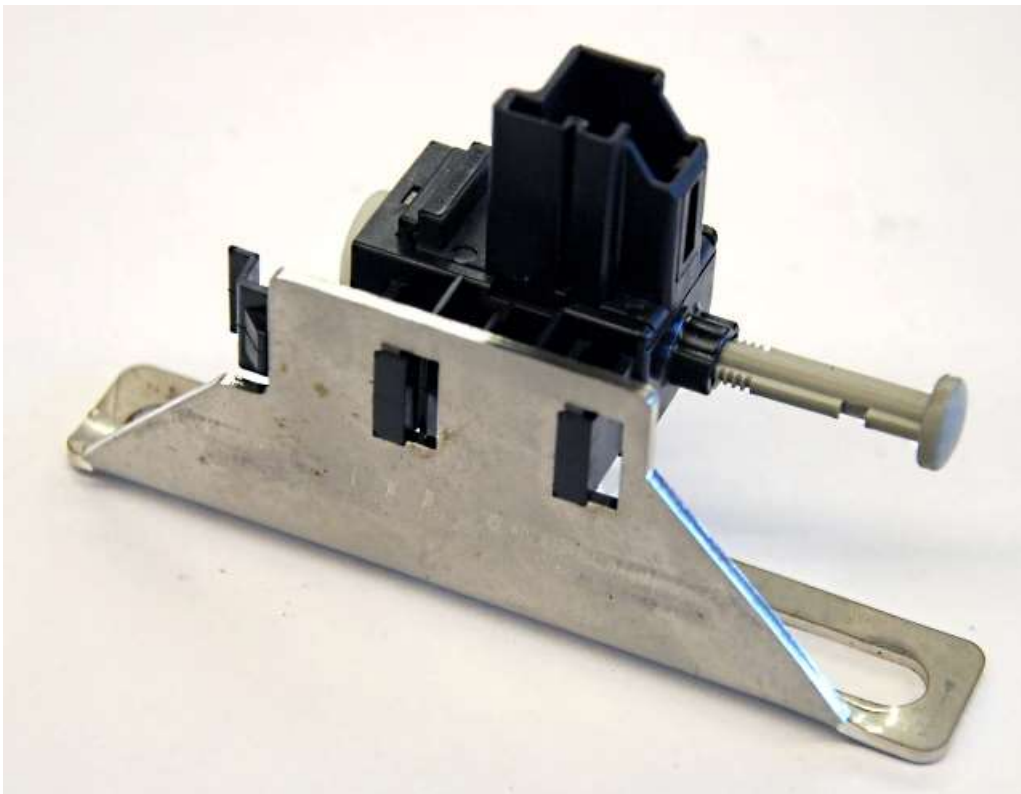

Attach the Bottom travel (gray plunger) clutch switch to the bottom travel switch mount as shown.

Remove the bolts holding the left side of the pedal box to the mount bracket.

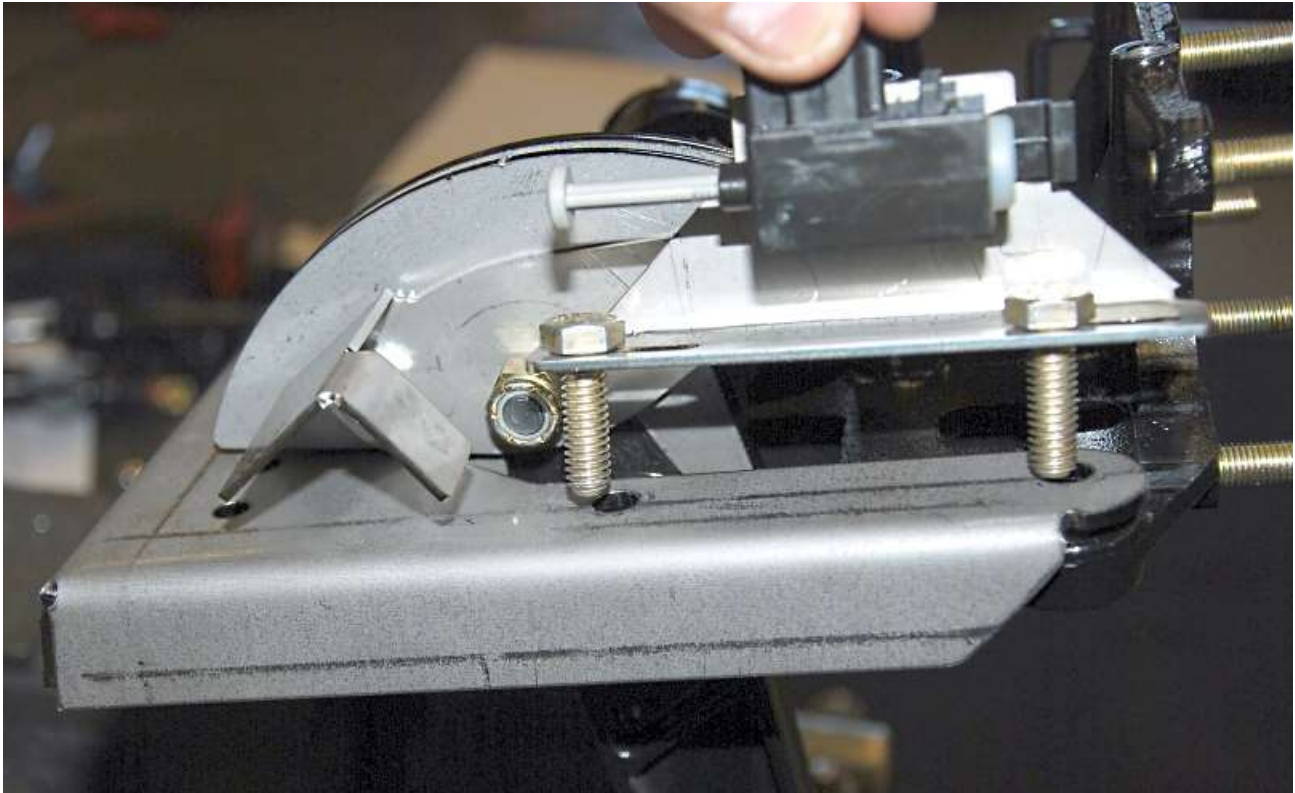

Insert the new $\frac{5}{16}$ " x 1.25" bolts through the bottom travel switch mount then through the pedal box bracket and pedal box.



Attach the top travel clutch switch bracket to the bottom of the bolts.

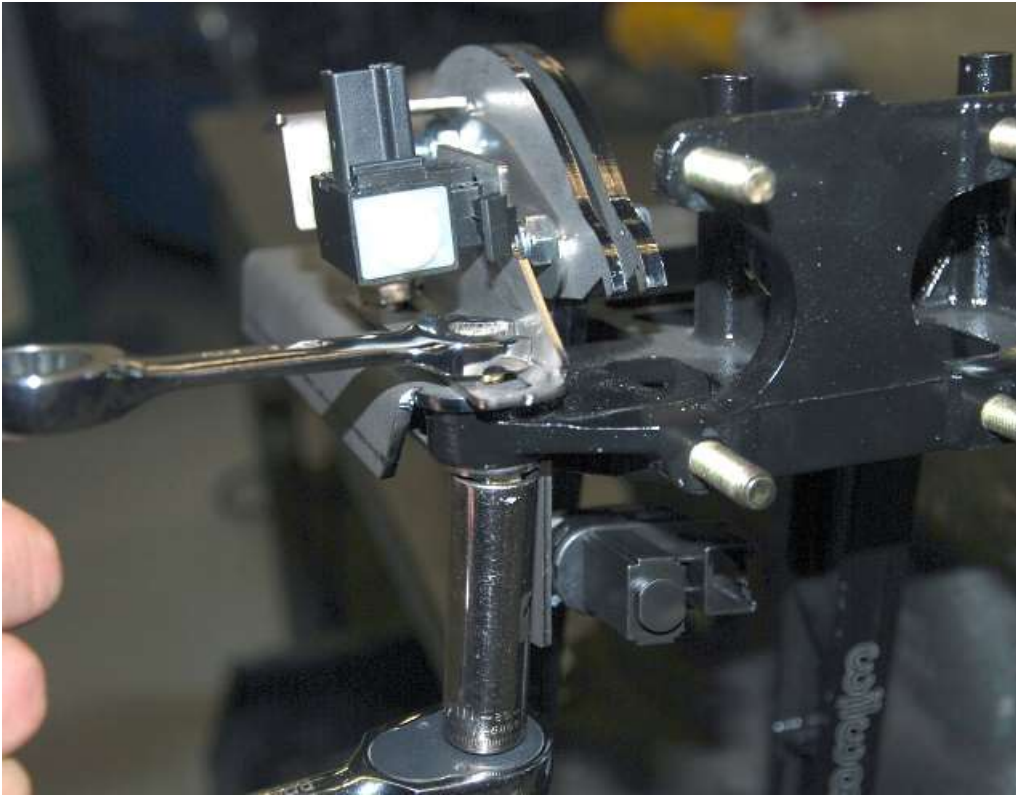

Snug the bolts up with a 1/2" wrench and socket so the bottom travel switch bracket can still move.

Reattach the clutch cable to the quadrant.



With the clutch pedal in its normal position, push the top travel switch in until it bottoms out on the pedal then tighten the #8 screws with a 1/4" socket and ratchet.

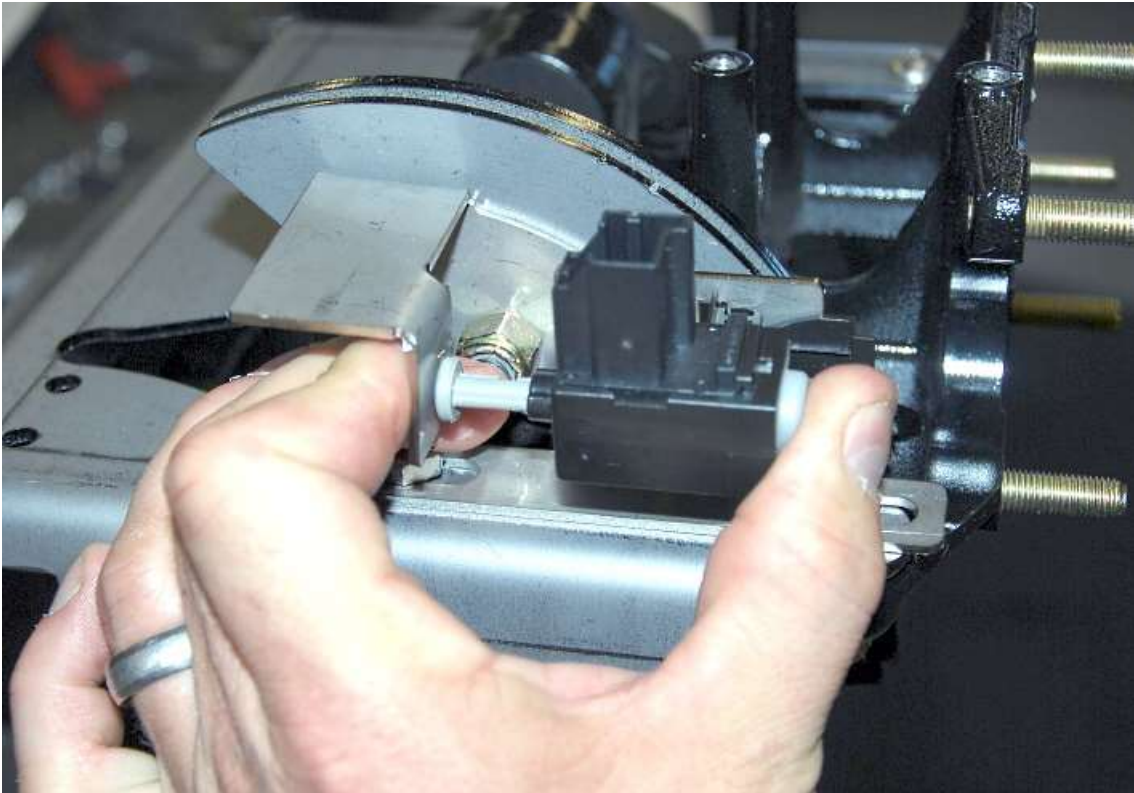

Have someone push the clutch pedal all the way in then slide the bottom travel switch mount so that the bottom travel switch is pressed in all the way against the quadrant plate. Hold the switch mount so that it does not move and let the clutch out then tighten the pedalbox mount screws with a ½” wrench and socket making sure the switch mount does not move.

Check the throw of the clutch pedal again carefully. The switches should get pressed in all the way but should not get pushed hard enough to stress/move the body of the switch.

Radiator Cooling Fan

- ✎ It is best to let the engine control the radiator fan. If you do not want to do this, do not use the control pack wires and remove the correct radiator fan fuse from the black box.
- ✎ Installation is similar for the 2015 and newer

2011-2014 PREP

Separate the orange and black fan wires.

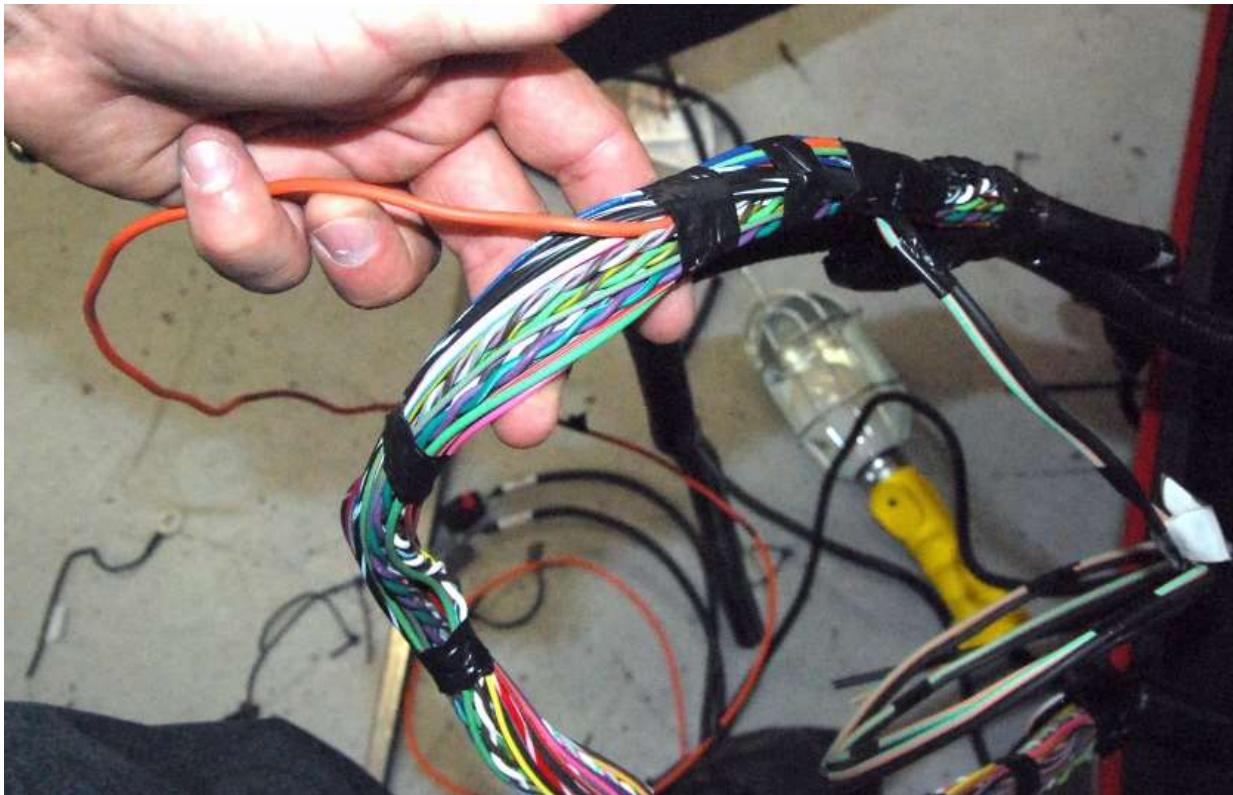

The orange wire in the engine harness needs to either be taped back along the harness or, a better way is to remove the engine harness wrap tape and pull the orange wire back to the last junction.

Remove the black ground wire completely. The fan is already grounded in the chassis harness.

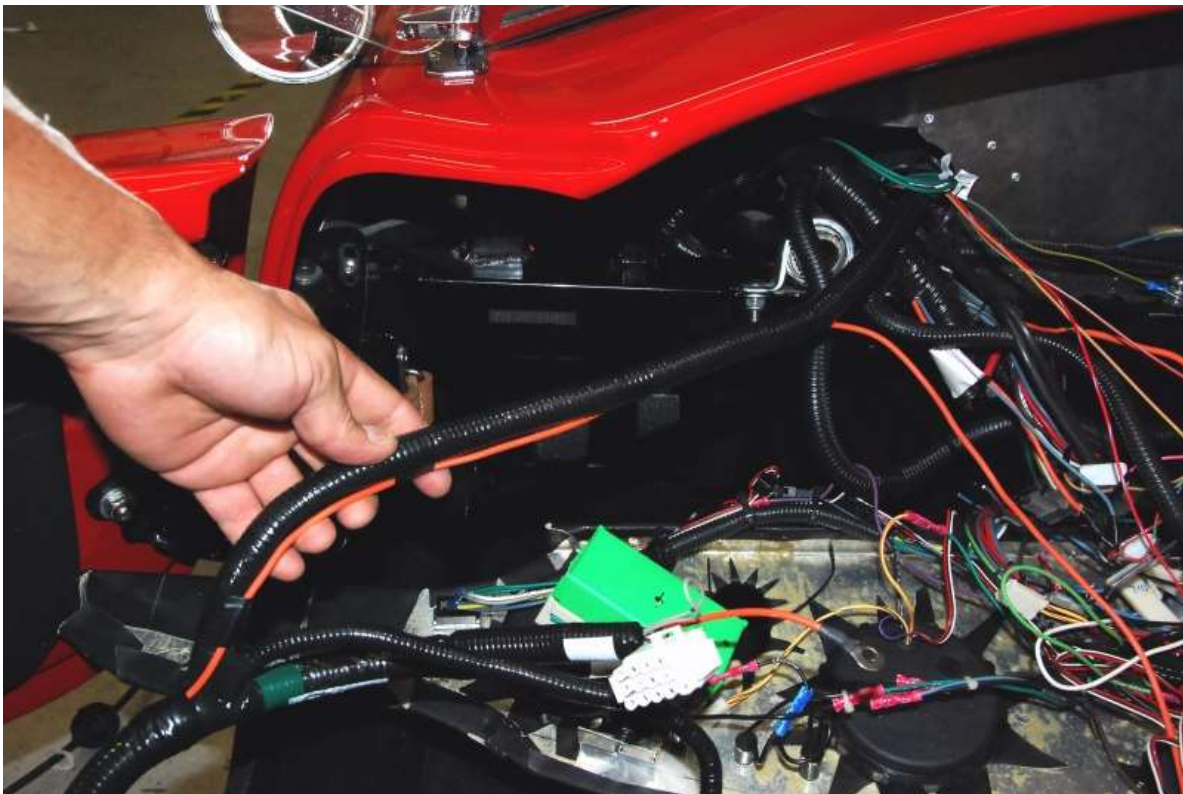

Run the orange wire along the outside of the harness going to the accelerator pedal.

- ✎ The Ford cooling fan circuit includes a fuse and relay in the black box.
- ✎ There are two ways to wire the cooling fan for 2011-2014:
 - Run the orange wire over to the fuse panel and use the Orange Ford wire to control the relay in the chassis harness. This would put a second relay and fuse in the circuit. The good side of this is that you can easily access the fuse and relay in the fuse panel. The fuse in the fuse panel would be the one that would burn out if there is a problem and you would not have to go into the black box ever. The down side is now you have 2 relays in the circuit.
 - The alternative wiring is to only use the black box fuse/relay and bypass the fuse panel.
- ✎ Both wiring methods are described below
- ✎ Installation is similar for the 2015 and newer. A third direct wire alternative is also shown.

WIRING USING THE FUSE PANEL

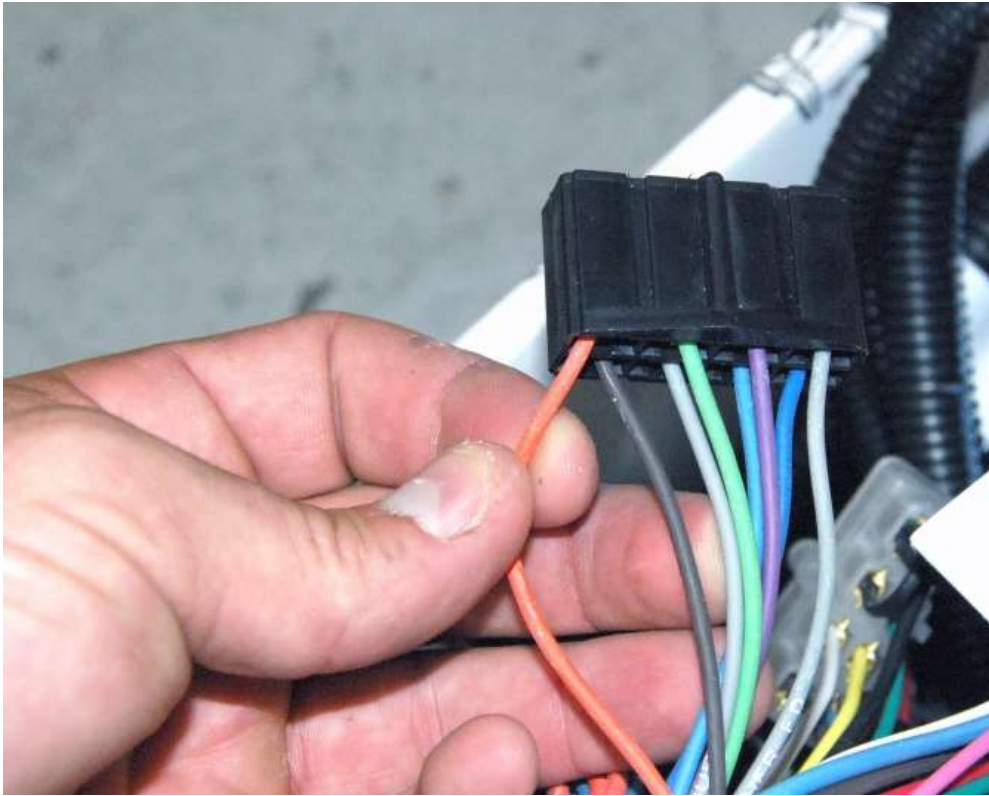

At the top of the footbox area, find the chassis harness orange fan wire in the dash harness plugs.
Cut the wire out of the plug.

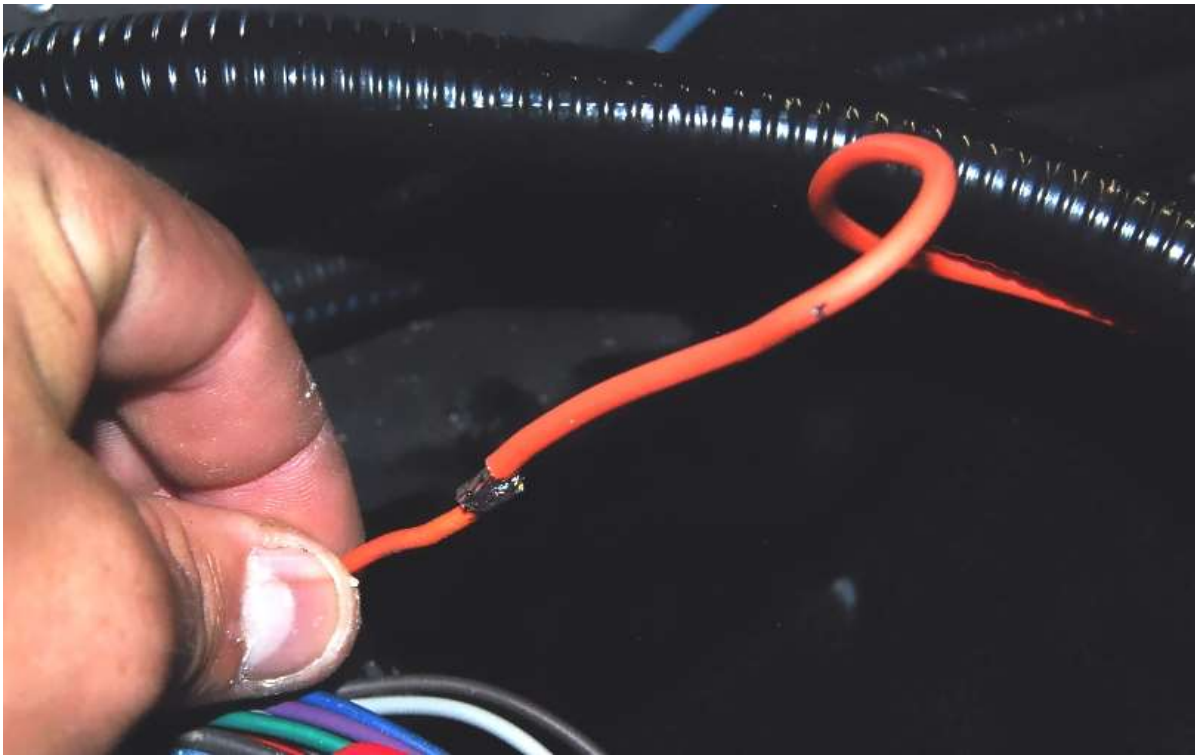

Solder or butt connect the orange fan wires together.

Skip to the next section.

WIRING BYPASSING THE FUSE PANEL

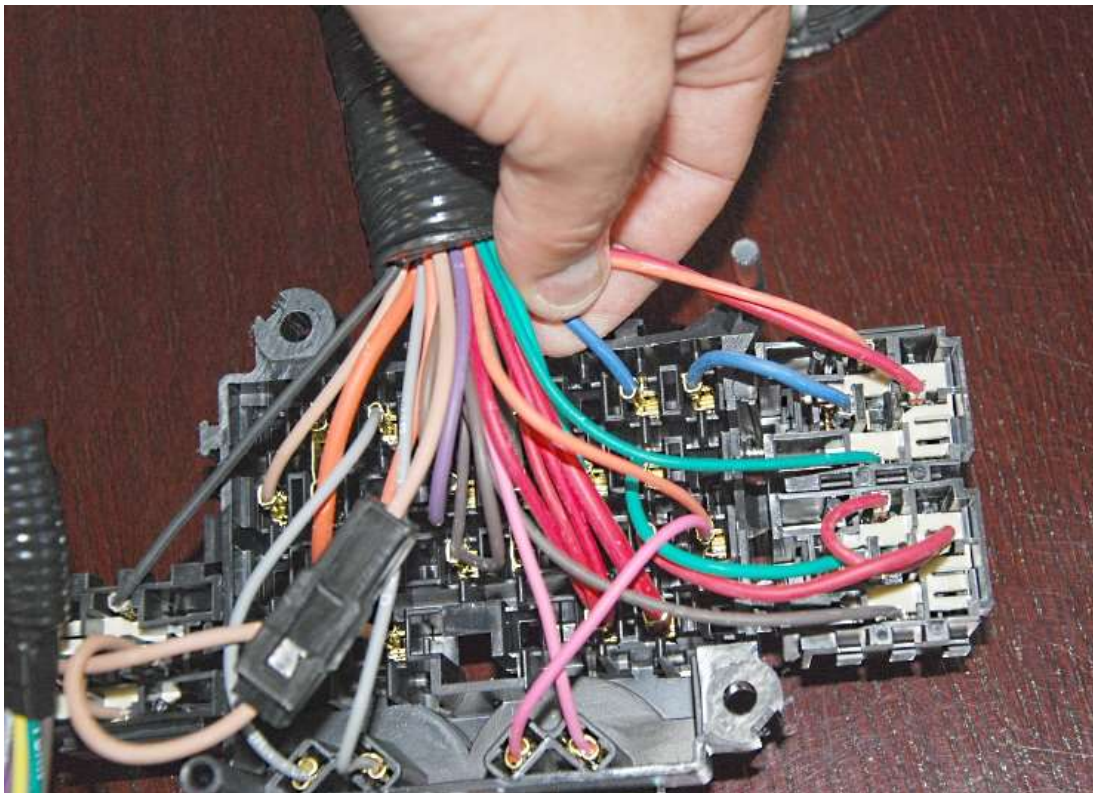

Locate the blue wire going into the harness on the opposite side of the cooling fan fuse from the blue wire coming from the fan relay.

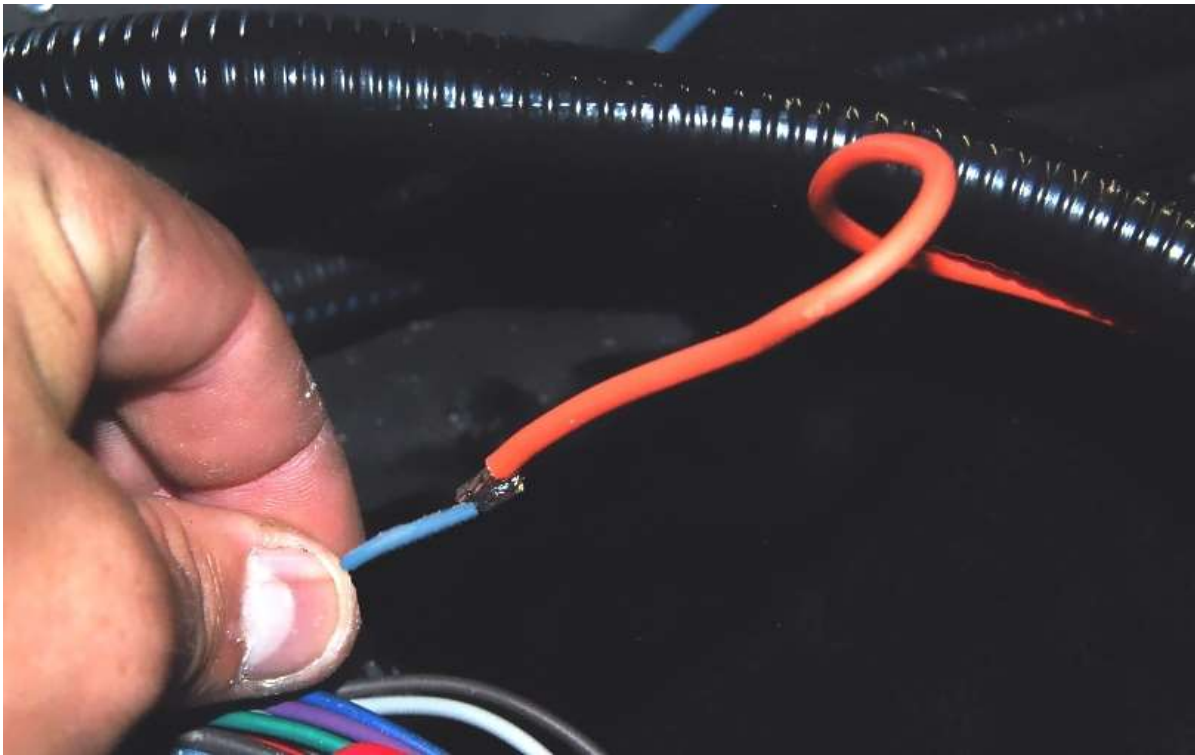

Cut the blue wire and solder it to the orange wire.

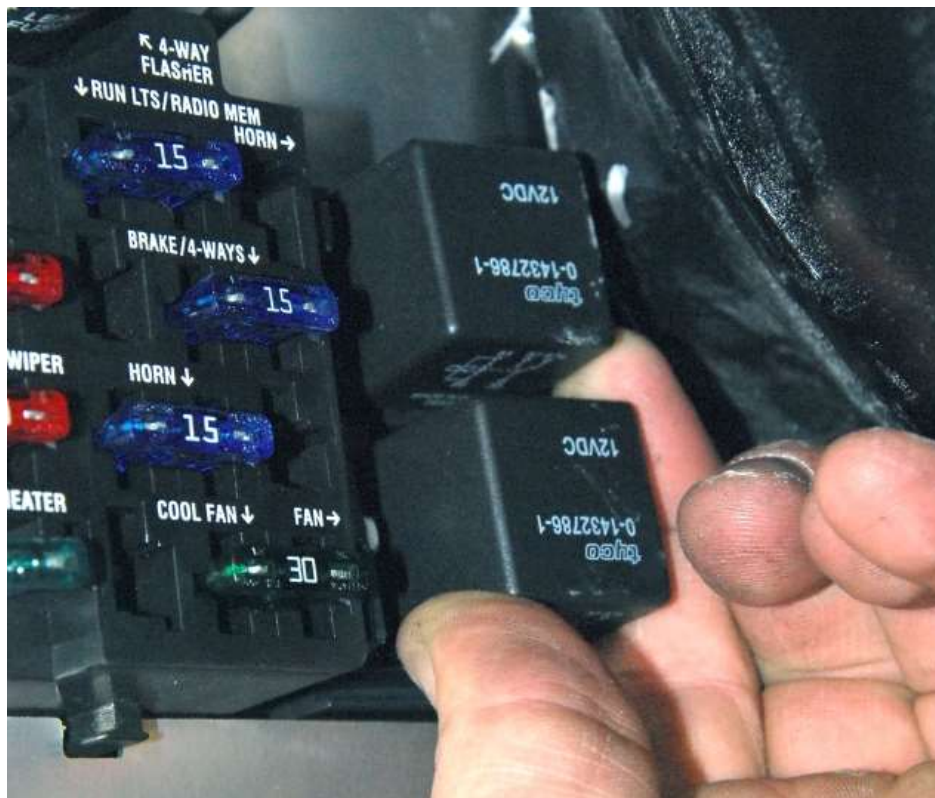

Remove the fan relay from the fuse panel.

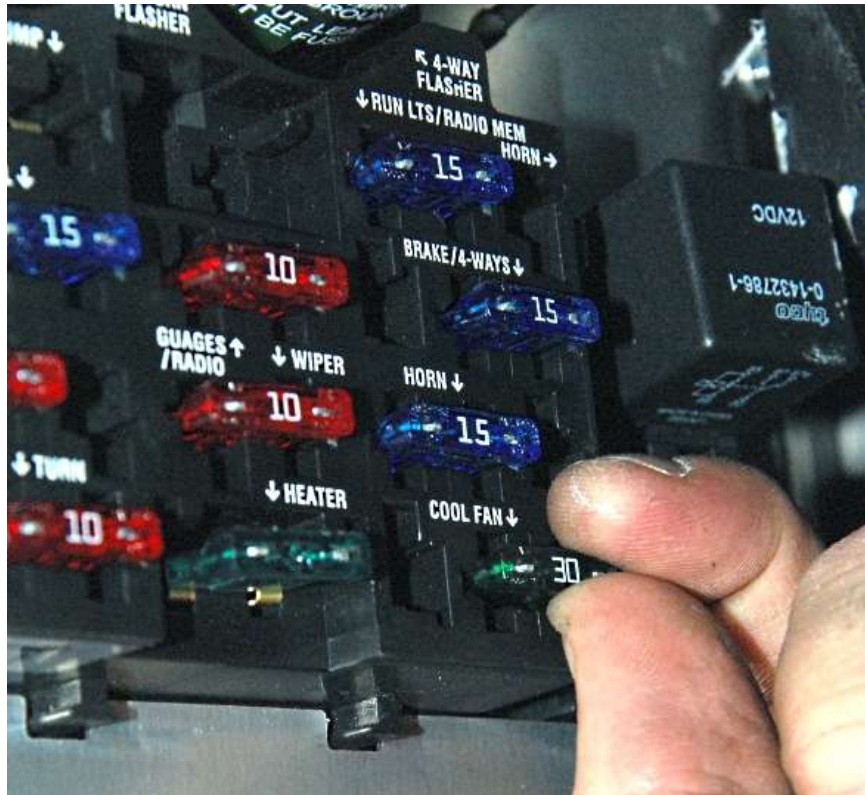

Remove the fan fuse.

The remaining fan wiring in the black box will be completed later.

2015 DIRECT WIRING



From the computer area, run the harness with the orange fan wire forward to the fan and connect to the blue fan wire.

Ground the black fan wire.

Power/start

✂ Soldering iron, wire cutters/strippers, electrical tape



Locate the EFI/crank and coil wires in the chassis harness.

2011-2014

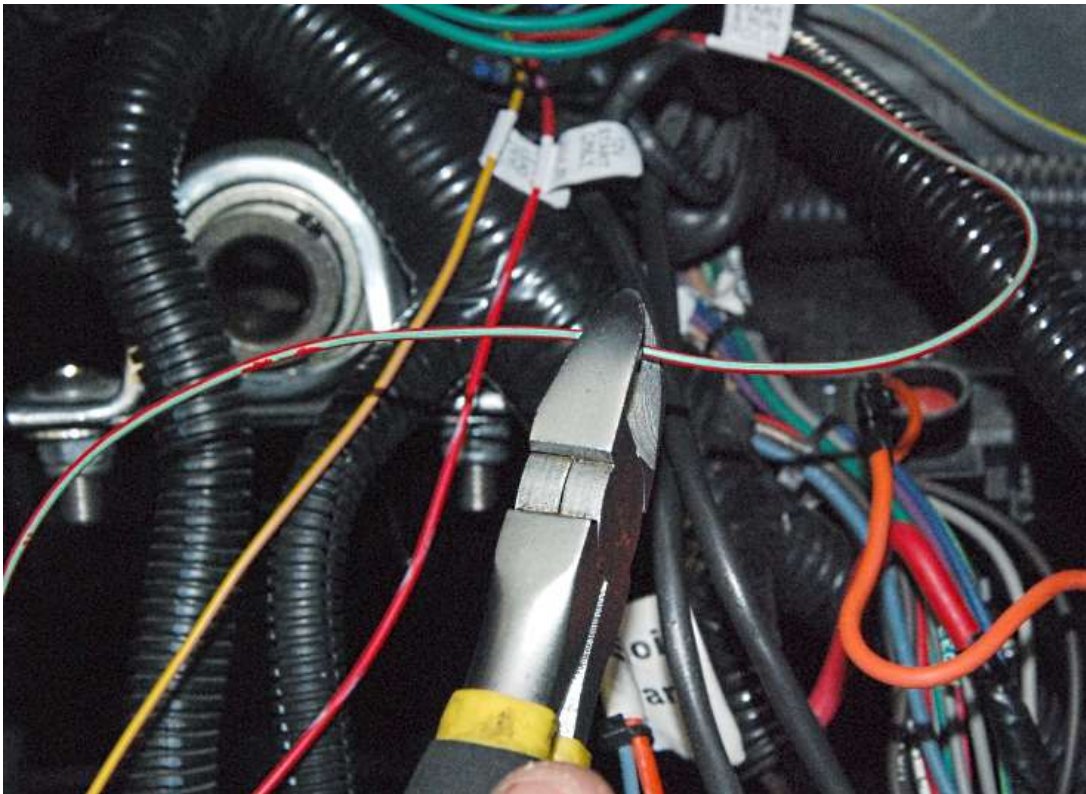

Route the Coyote 12v start/run wire (red/green) and 12v start (red/blue) wires to the chassis harness EFI wires and cut to length.

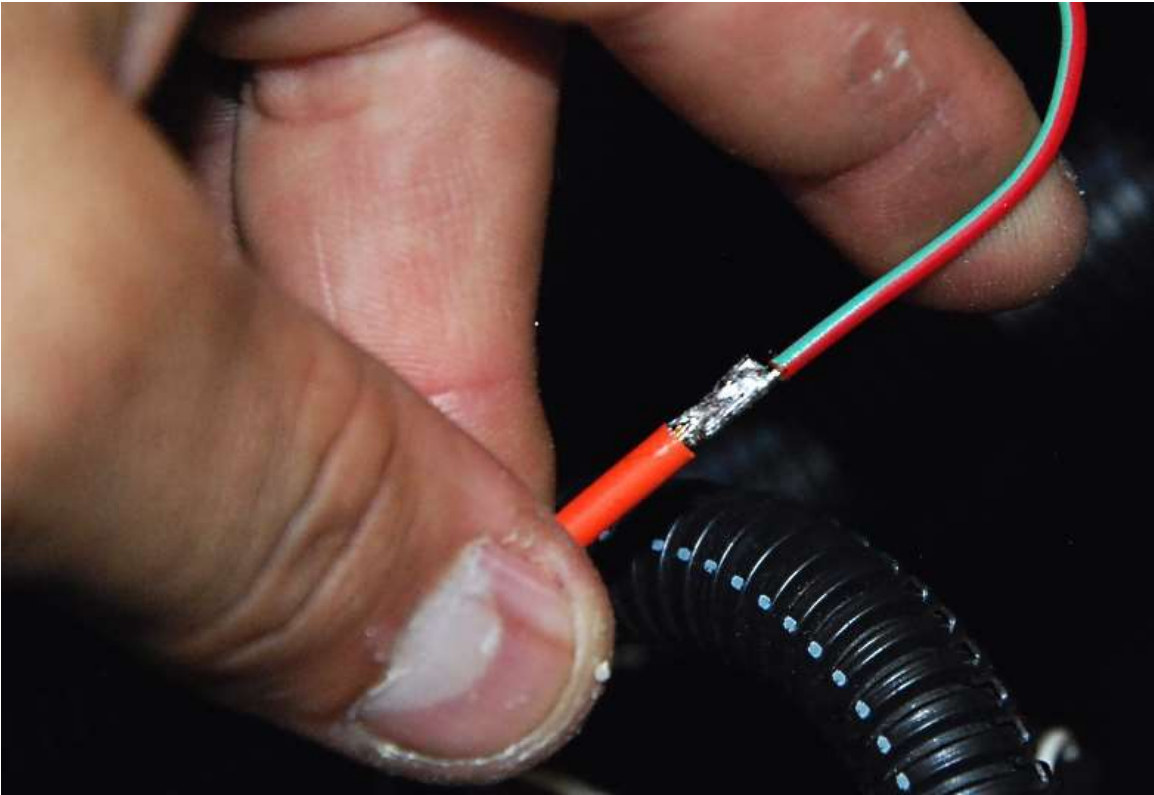

Connect the 12v start/run wire (red/green) wire to the orange coil wire.

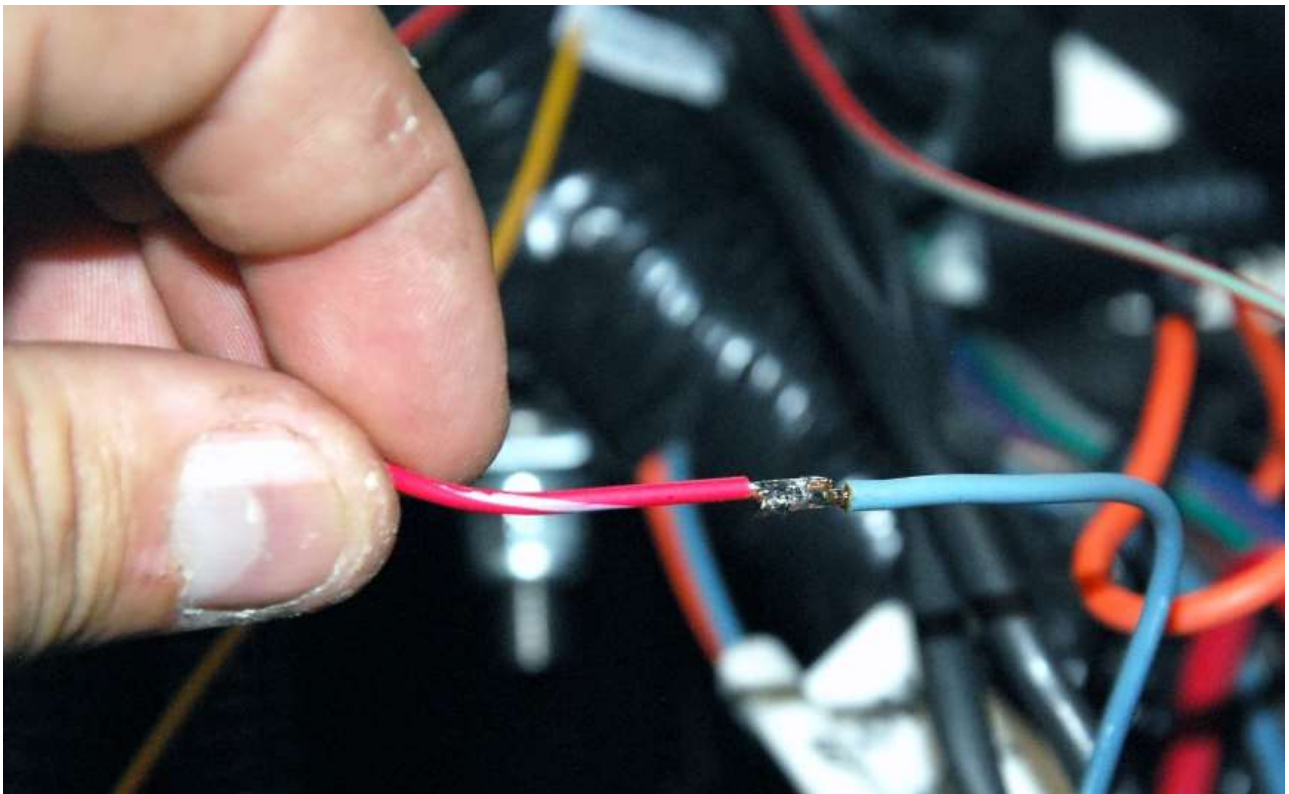

Connect the 12v start (red/blue) wire to the blue crank wire.

2015 & NEWER

✂ Soldering iron, wire cutters/strippers, electrical tape

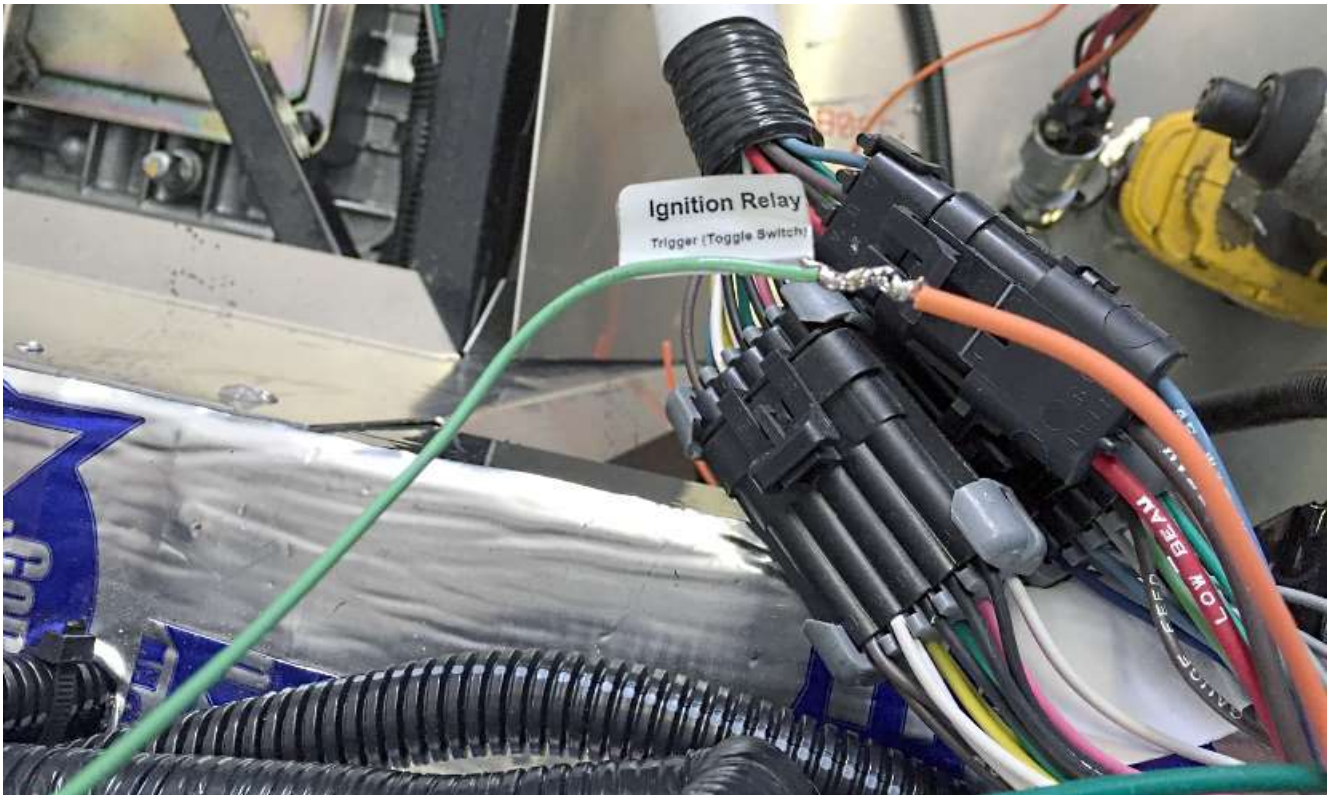

On the 16 way connector, connect the 12v Ignition relay trigger wire (light green) wire to the orange coil wire.

On the 16 way connector, ground the black wire as instructed in the Ford Performance instructions.

On the 16 way connector, do not connect the yellow wire. Doing so will make the engine run after the key is shut off.

👉 No other wires are used from the 16 way connector.

👉 We use the Non-PCM engine starting directions in the Ford Performance instructions. This uses the chassis harness starting wire to engage the starter.



If a neutral safety switch is not going to be used, connect the two blue chassis harness wires together by either soldering the wires or using a butt connector from the “misc. electrical components” assembly in the Factory Five Racing main kit pack.

Tach

✂ Soldering iron, wire cutters/strippers, electrical tape

2011-2014

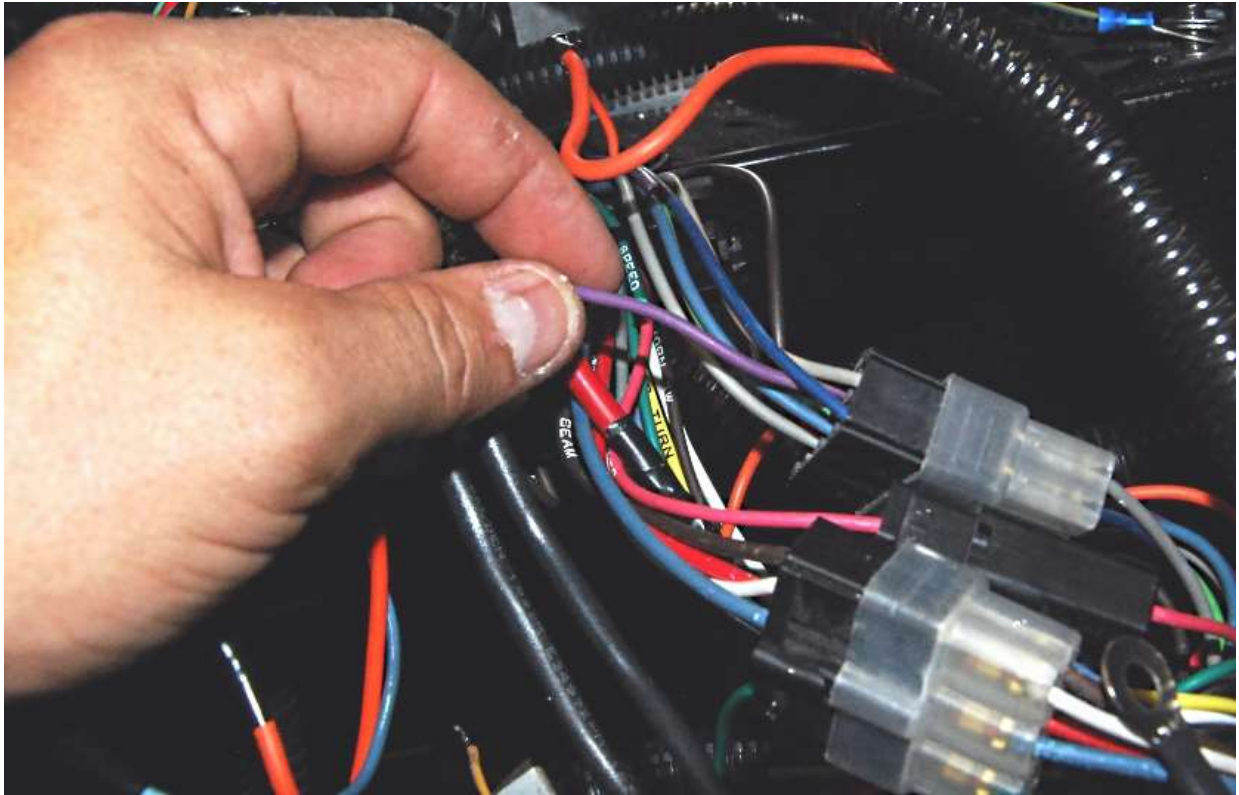

Find the purple tach wire in the sending unit plug and cut it so the engine harness can get connected to the purple wire.

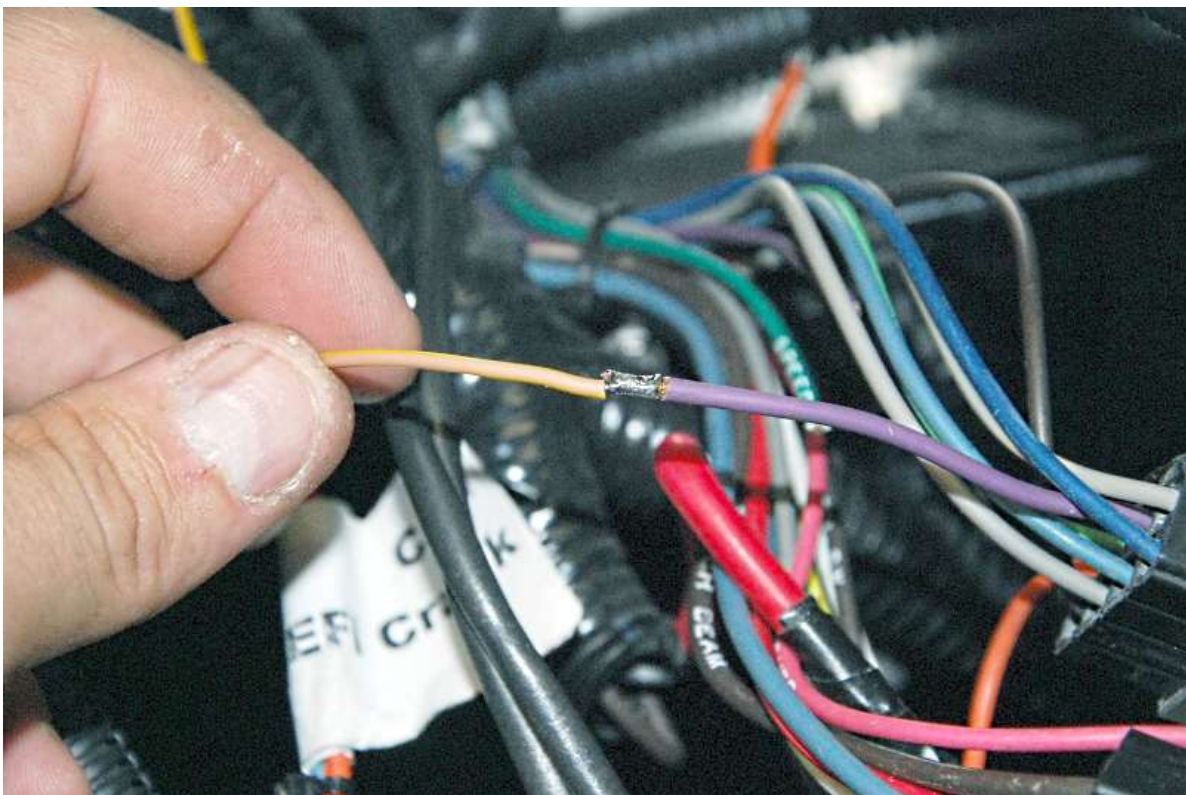

Connect the tach wire to the chassis harness plug and connect it to the purple wire attached to the plug.

2015 & NEWER

There is no tach wire in the engine harness. The tach will need to get connected to a coil wire as shown in the gauge instructions according to the #3 Coil on plug description.

Alternator

🛠 Ford Racing Alternator kit, battery cable

Attach the coyote harness alternator plug to the alternator.
Run the chassis harness red alternator wire to the alternator output post.
Cut the wire so that a ring terminal can be used on the alternator.

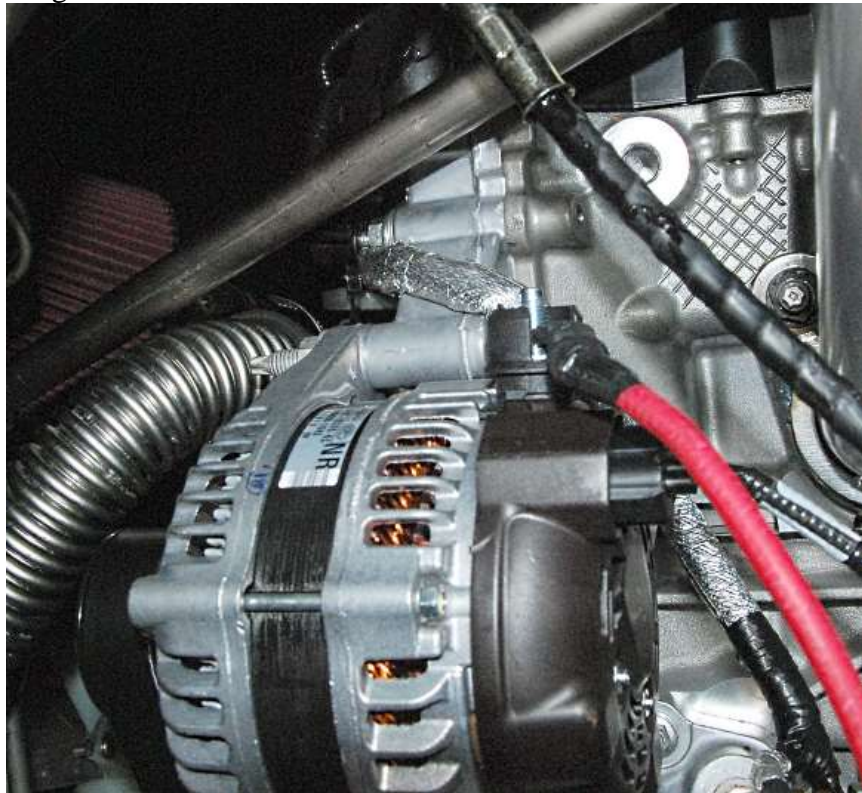

Crimp on a ring terminal and attach the red wire to the Alternator.

O₂ Harness

✂ Soldering iron, wire cutters/strippers, electrical tape

2011-14

Locate the O₂ wires in the Coyote harness.

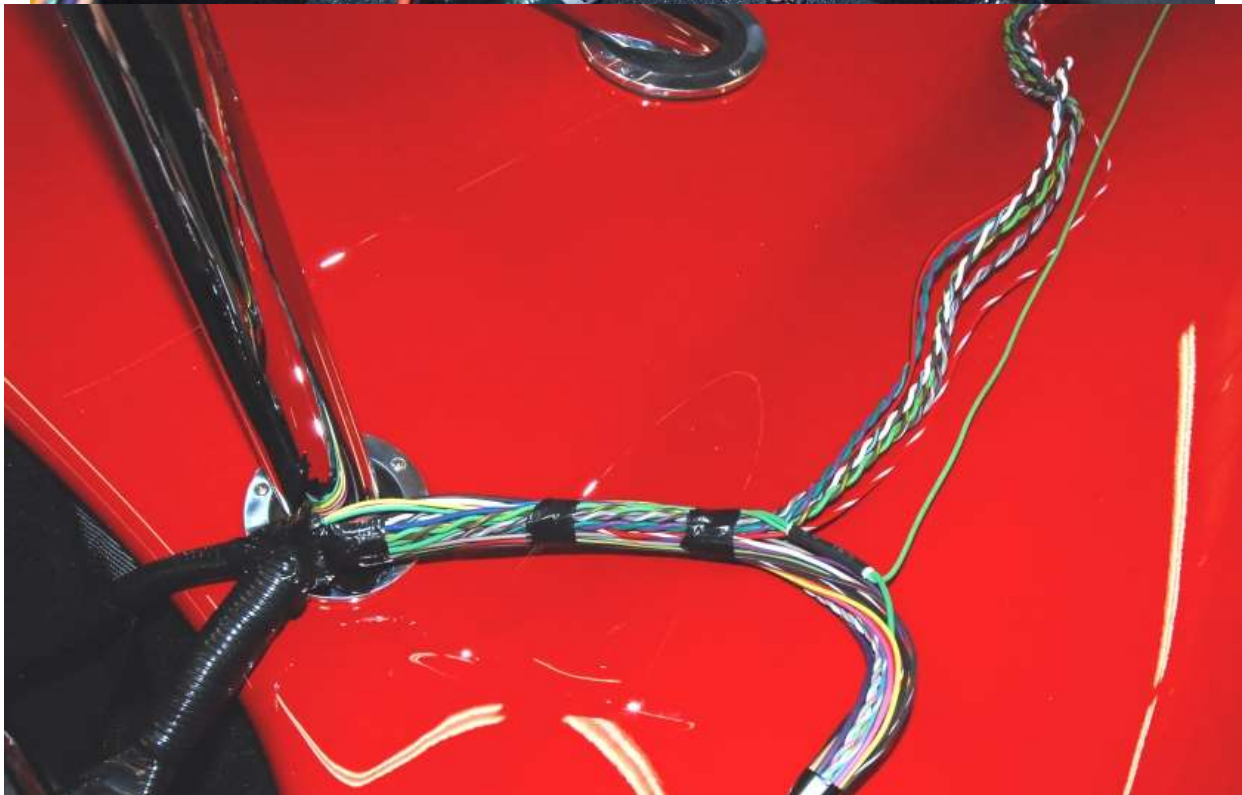
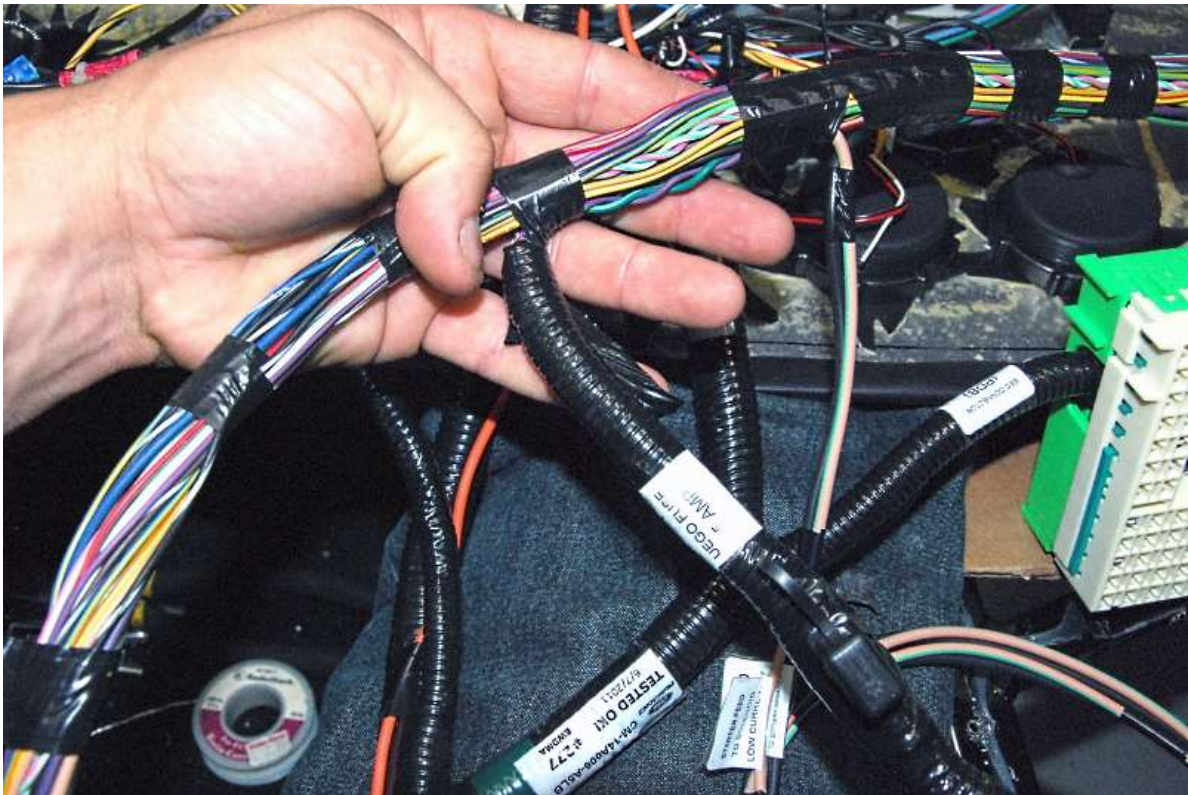

Remove the harness wrap and pull the wires back to the first harness branch. This will allow them to get routed in the engine bay with enough length.



Locate the red/black power wire junction between the two O₂ sensor plugs.

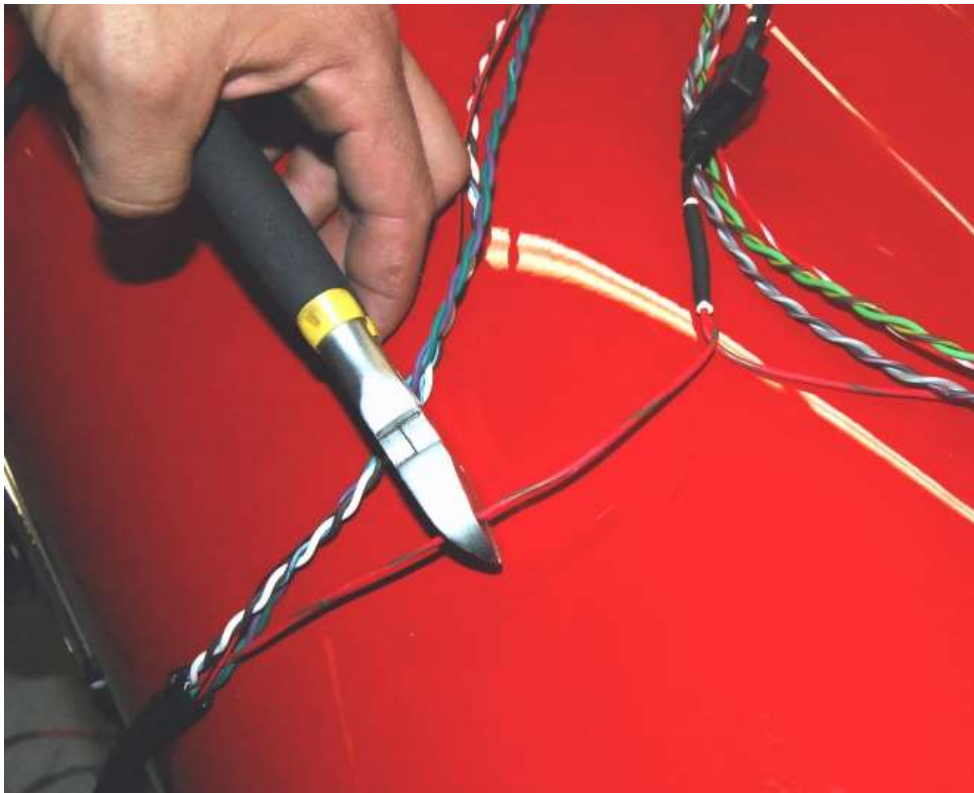

Cut the wire for the left side O₂ sensor a few inches from the junction.

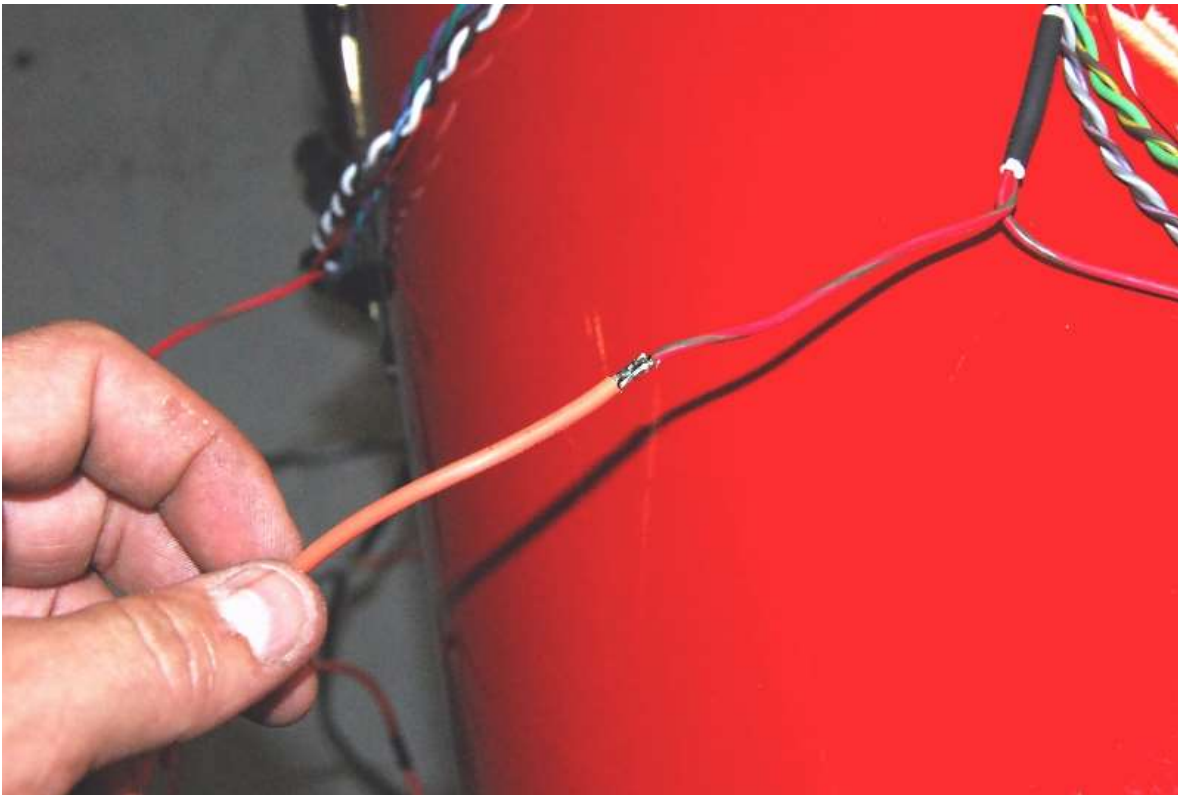

Use one of the extra wires pulled out of the harness or chassis harness to extend the wire. Start by soldering the wire to the end near the junction.

Pull the left side O₂ sensor wires so they are tight.

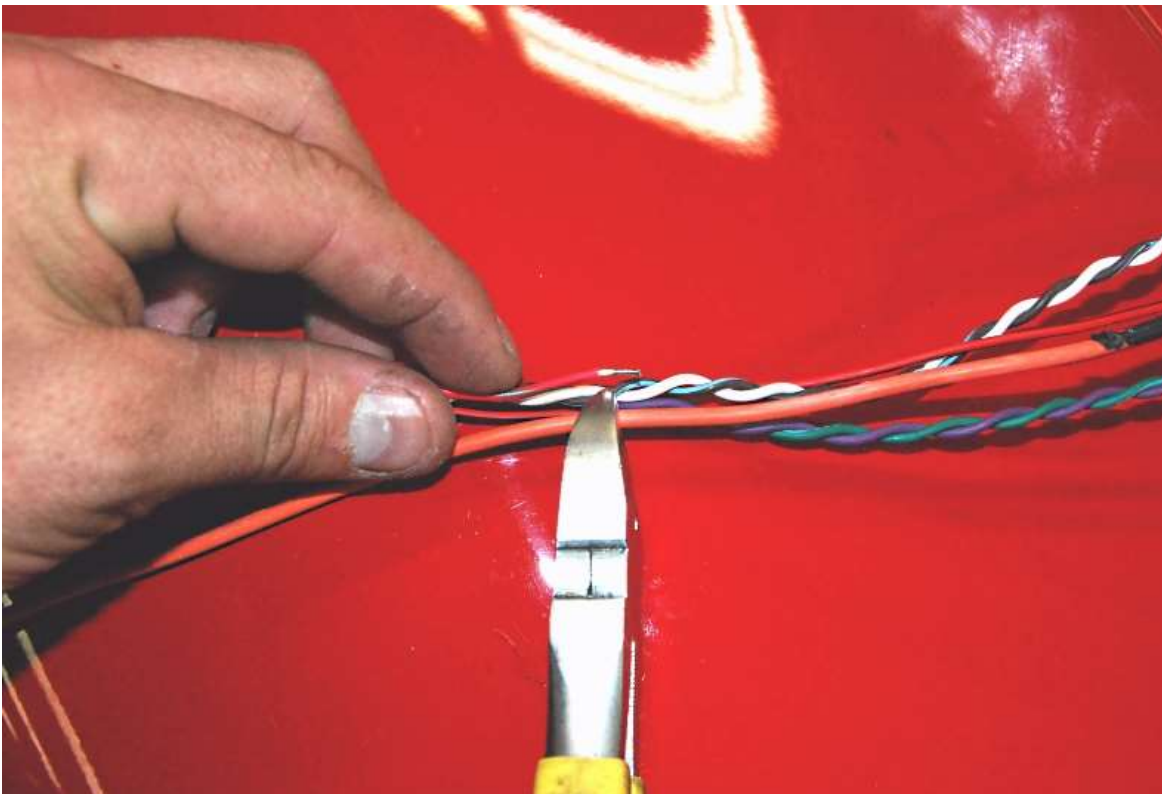

Pull the wire extension tight and cut to length.



Solder the other end of the extension wire to the O₂ sensor wire.



Recover the harness with the original conduit.

2015 & NEWER



Attach the right O₂ sensor to the connector at the back of the head.



Connect the left O₂ sensor to the connector down near the engine mount

Starter Solenoid

☞ The solenoid on the starter is the one being used to start the engine.

Run the battery cable to the starter solenoid along the transmission from the battery.



Attach the battery cable to the starter solenoid.

☞ Make sure not to push the cable too far over or it may contact the starter post.

2011-2014

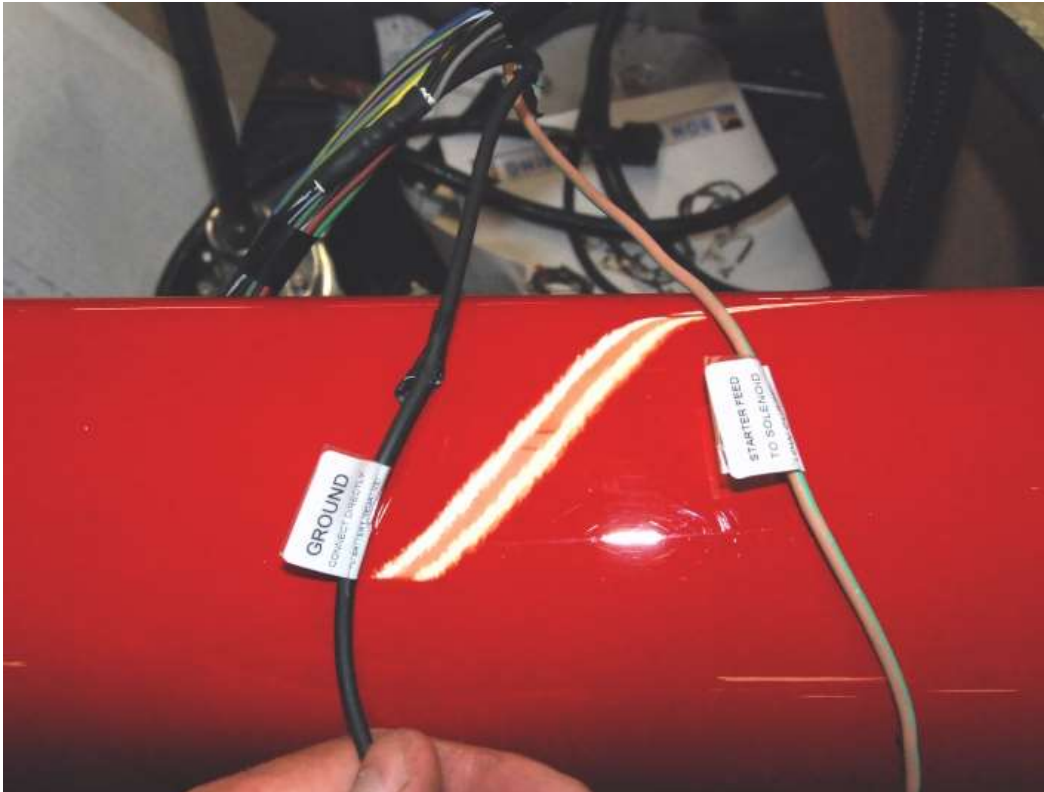

Separate the solenoid and ground wires.

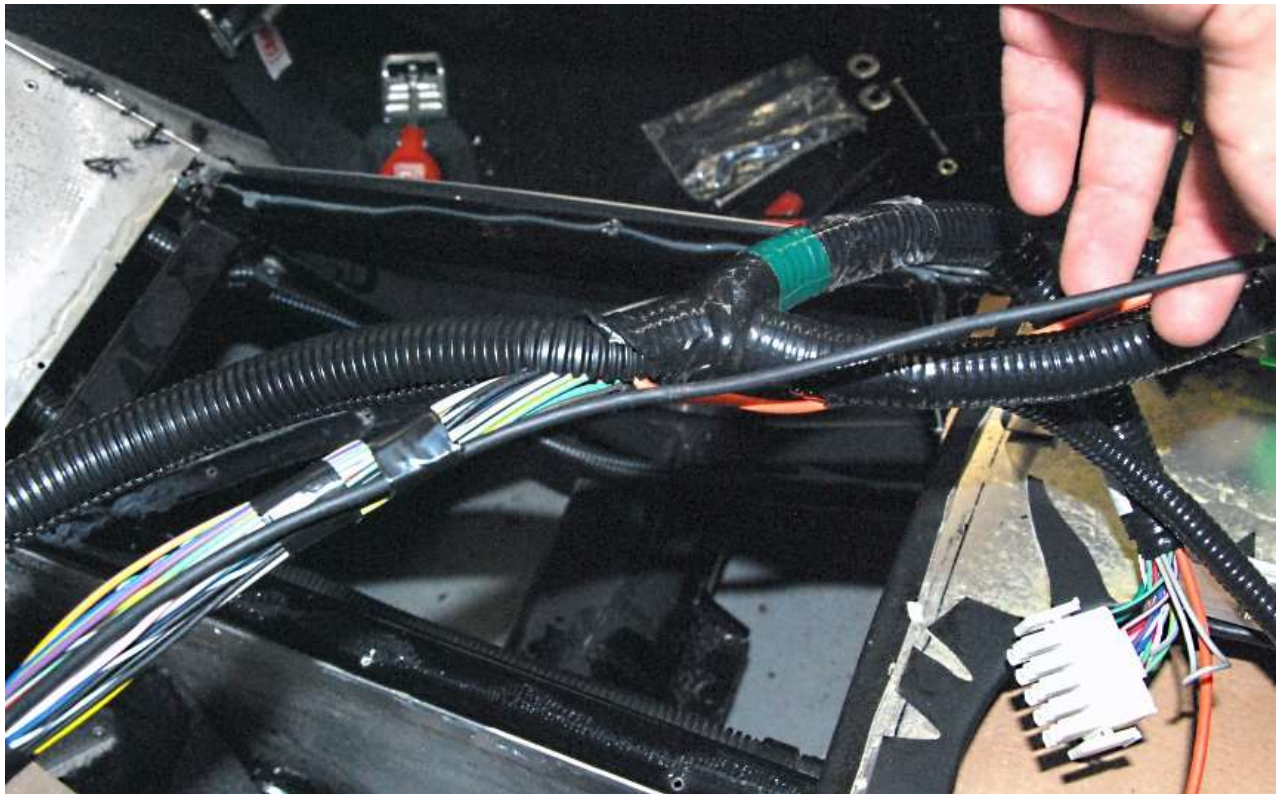

Tape the ground wire back along the harness to a common frame ground.

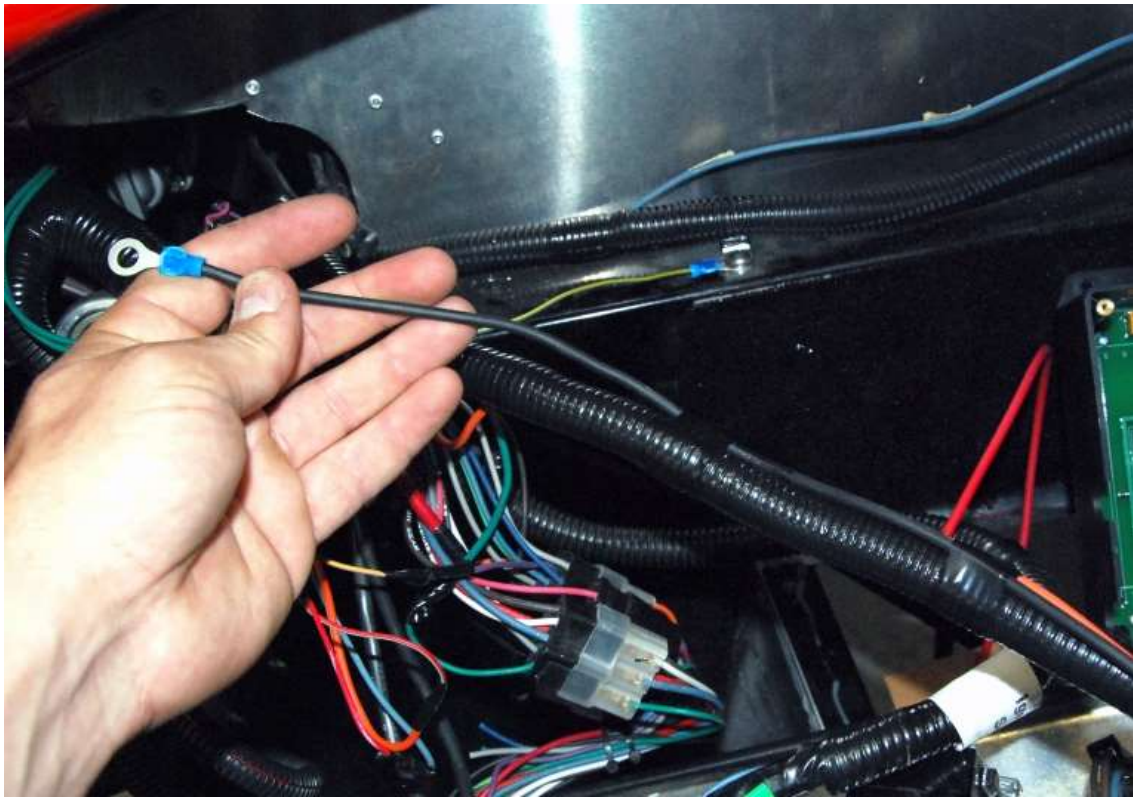

Crimp a ring connector to the ground wire.

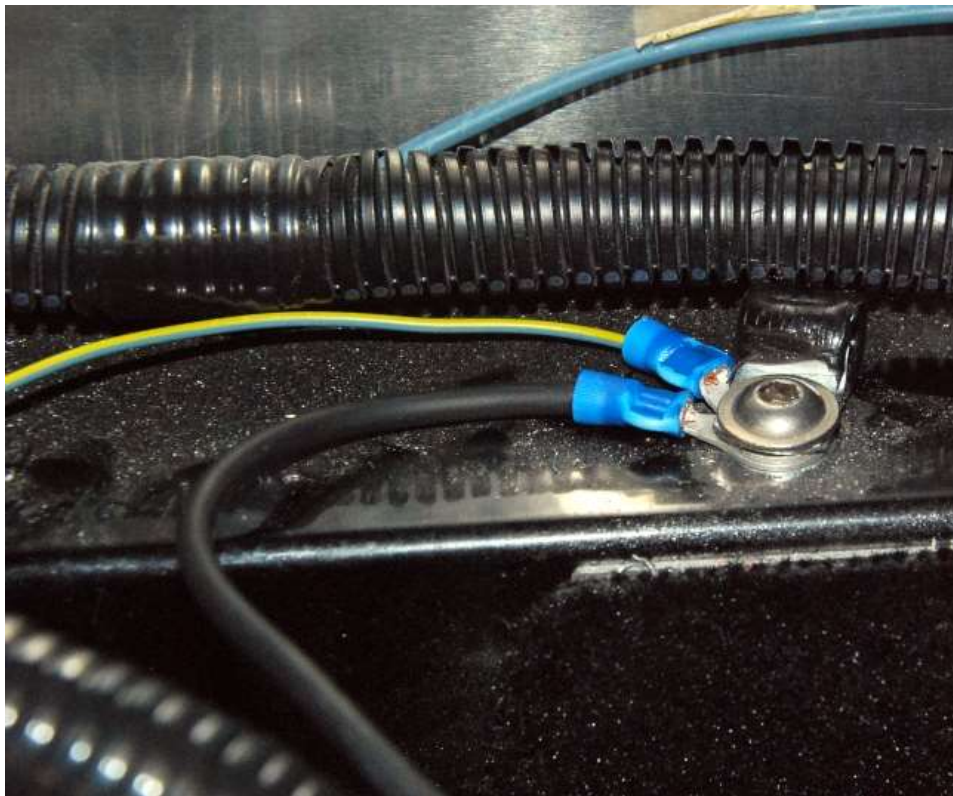

Attach the ring connector to ground.



Attach the tan/green wire to the starting post on the solenoid.

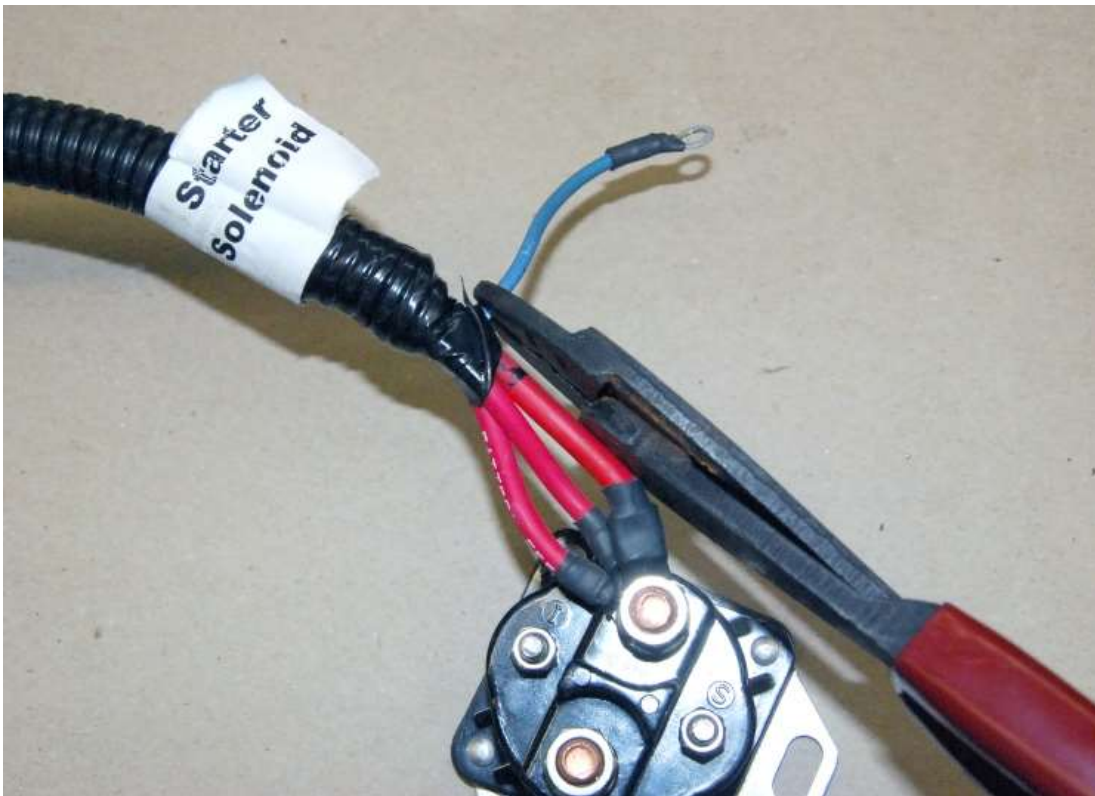

Cut the chassis harness blue starter solenoid wire back to the harness conduit.



Use electrical tape to cover the end of the blue wire.

2015 & NEWER

- ✂ $\frac{5}{32}$ " hex key, $\frac{1}{2}$ " wrench, $\frac{1}{4}$ " drill bit, 1" hole saw, drill
- 🔩 $\frac{1}{4}$ "-20 stainless washer head screws, locknuts, expandable grommet, Ford Performance control pack in-line fuse mount and 4ga battery cable.



Locate and mark the inline fuse just to the left of the dash support post on the firewall or on the 2" tube.

If firewall mounting, drill $\frac{1}{4}$ " holes and use the $\frac{1}{4}$ " x 0.75" stainless washer head screws, locknuts along with a $\frac{5}{32}$ " hex key and $\frac{1}{2}$ " wrench to attach the fuse mount to the firewall.

If mounting the fuse mount to the tube, use the #8 x $\frac{3}{4}$ " self-tapping screws.

Wire the fuse and harness per the Ford performance "Power distribution Box Installation Instructions".



Drill a 1" hole at the bottom in the center of the firewall then insert the expandable grommet.

Run the positive battery cable connecting to the fuse out of this hole and to the battery side of the starter solenoid on the starter.



Ground the control pack harness to the frame, make sure to remove any frame coating to ensure a good ground.

Black circuit Board box

- ✂ Small and Large Philips head screwdriver
- 👉 2011-2014 only

Inside the car, find a location that you can mount the black box from the coyote harness. We mounted it to the left of the center support.

- 👉 Do not mount the box yet.

Open the black box and remove the nut on the post marked “fan”.

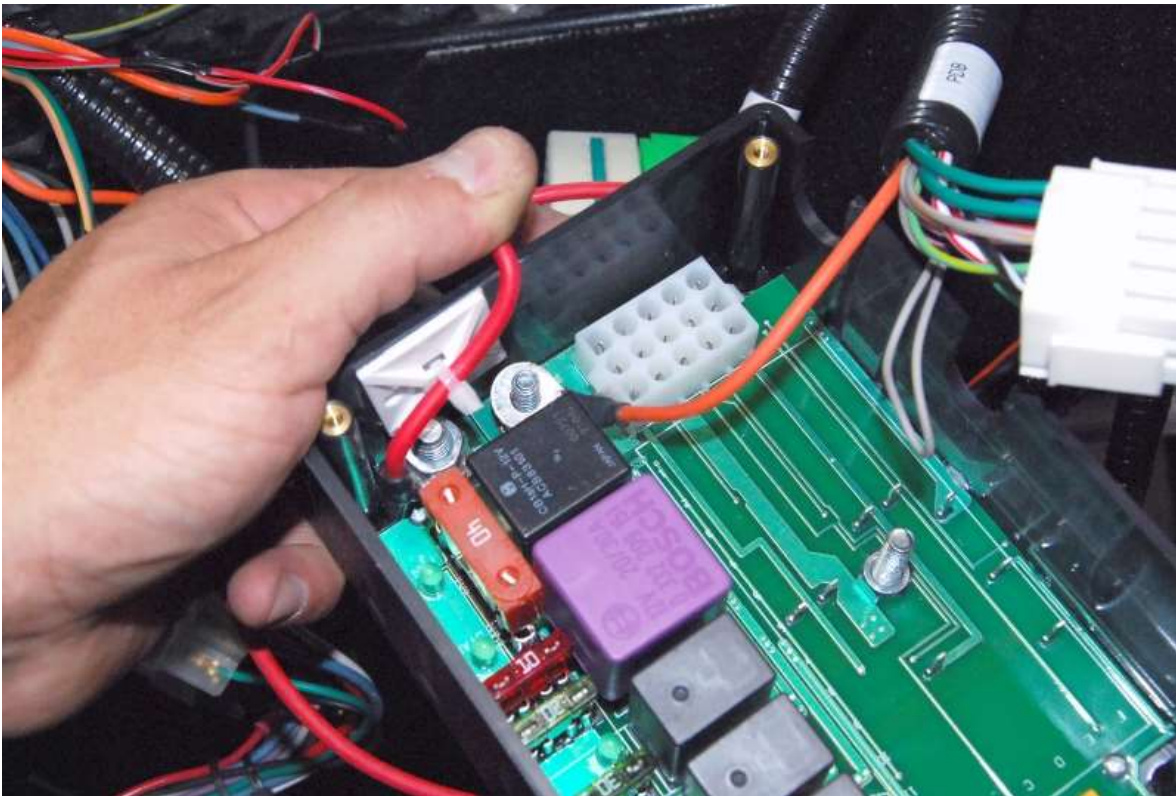

Put the orange wire ring connector onto the post.

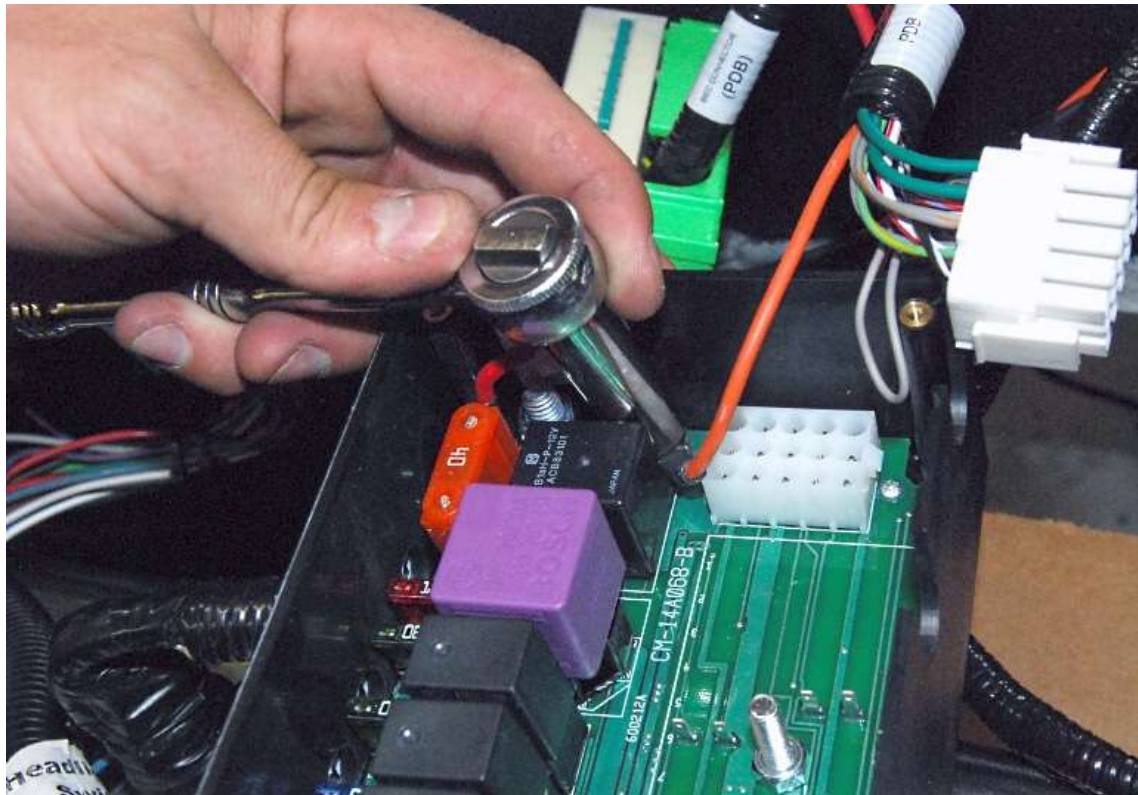

Tighten the nut on the fan post then bend the ring connector up so the wire clears the white connector.

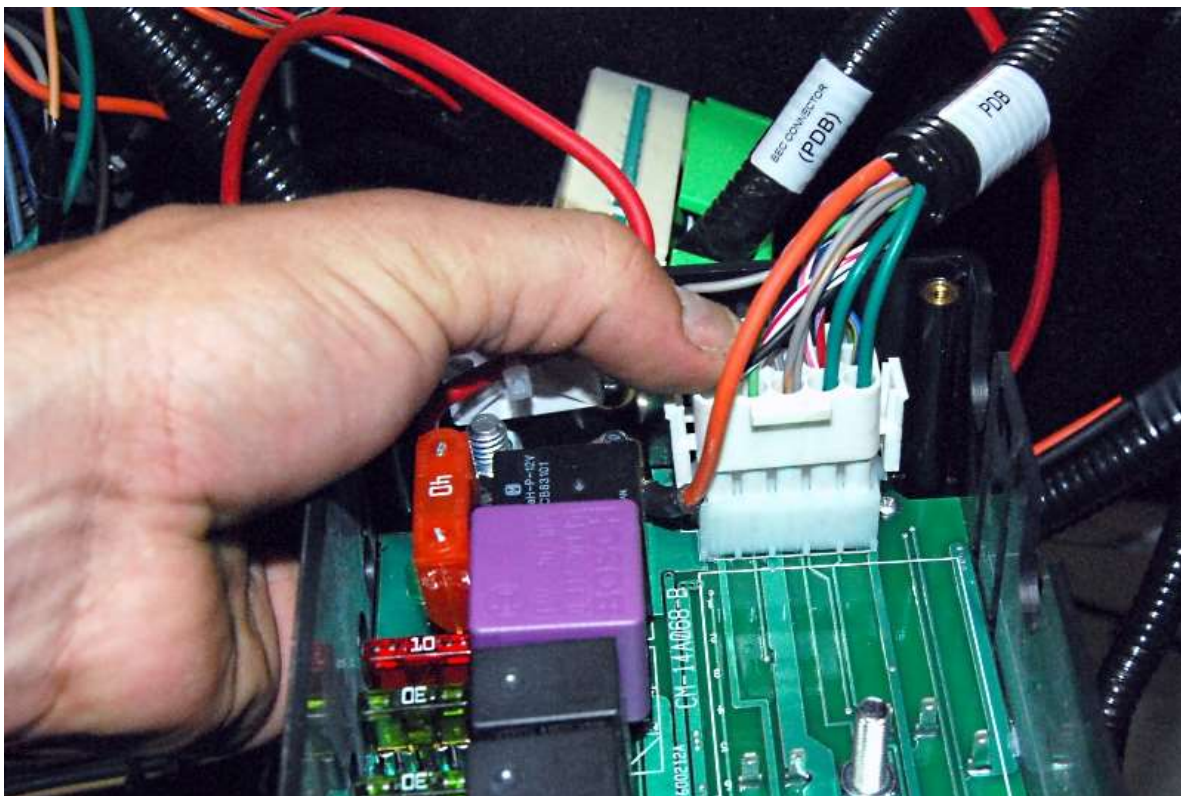

Push the white multipin connector onto the matching connector on the circuit board.

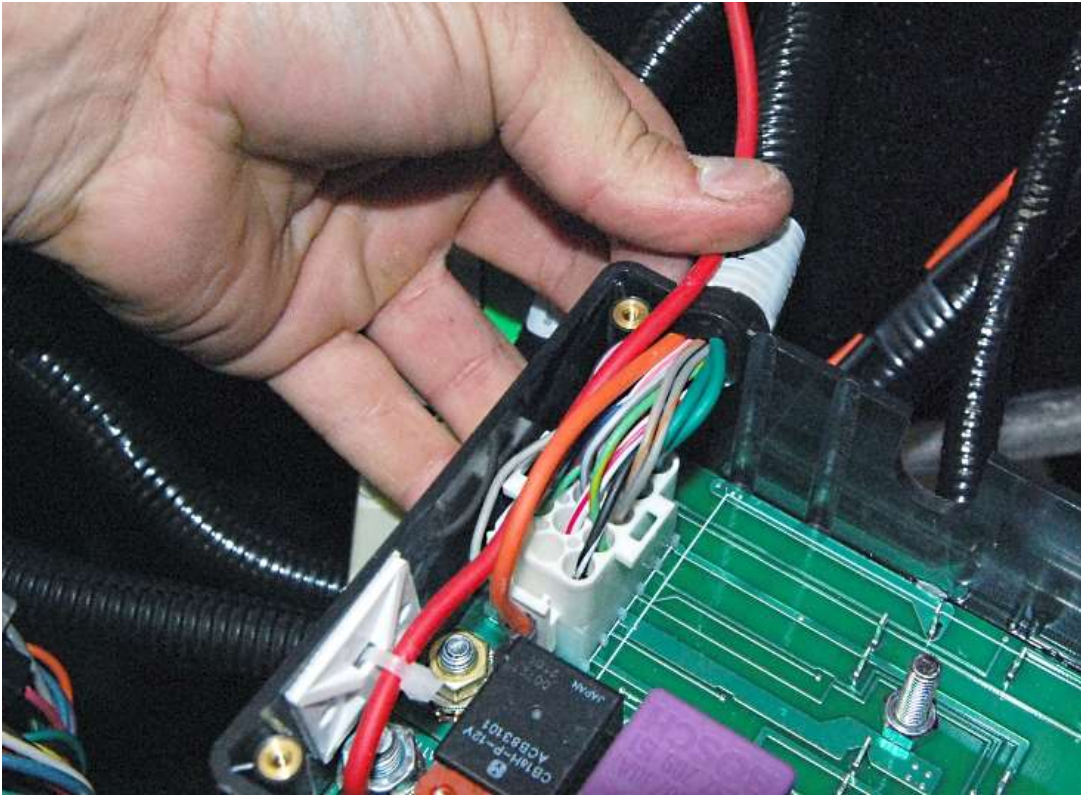

Run the white plug wires and the orange fan plug out of the box in the slot provided near the plug.

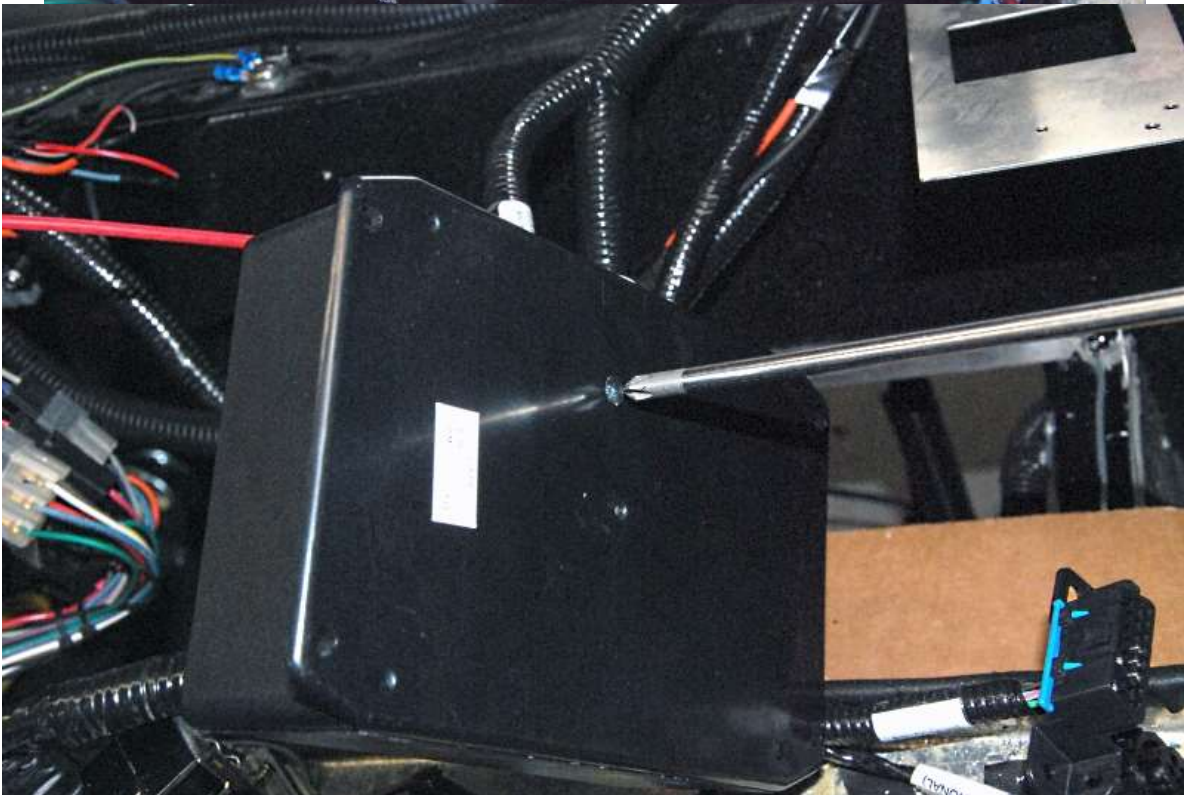
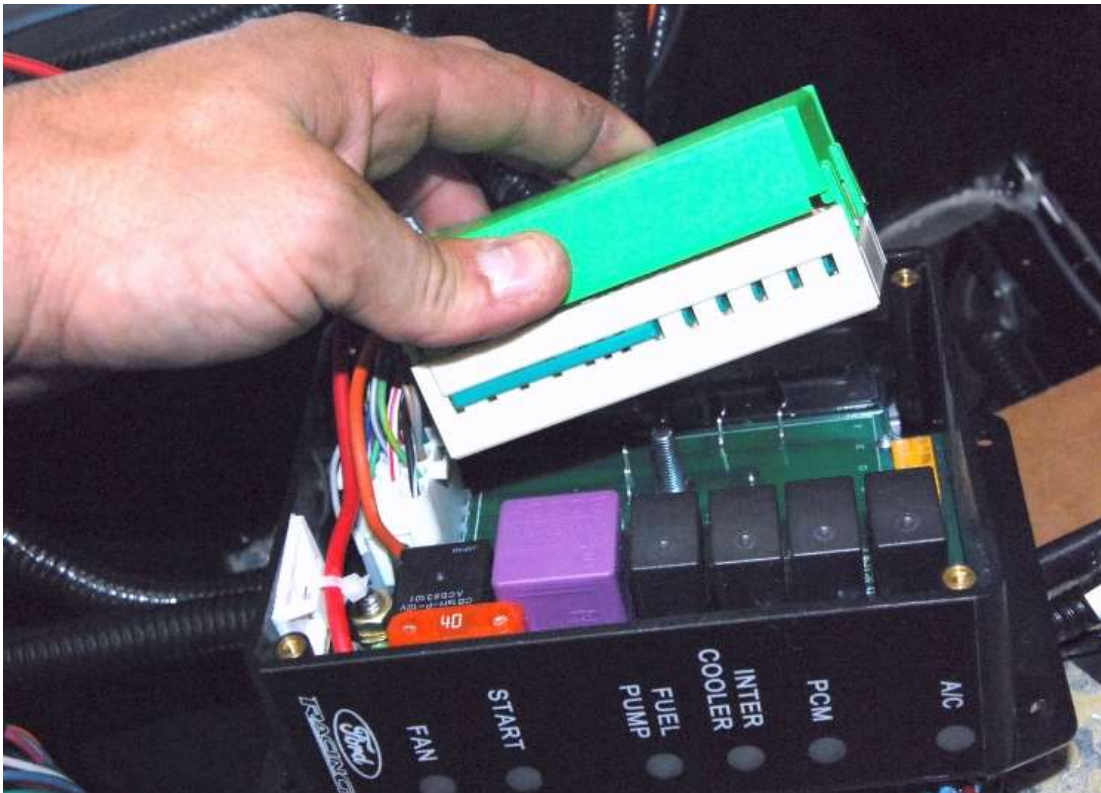

Connect the green power plug inside the box. It gets attached using a large Philips head screwdriver through the bottom of the box.

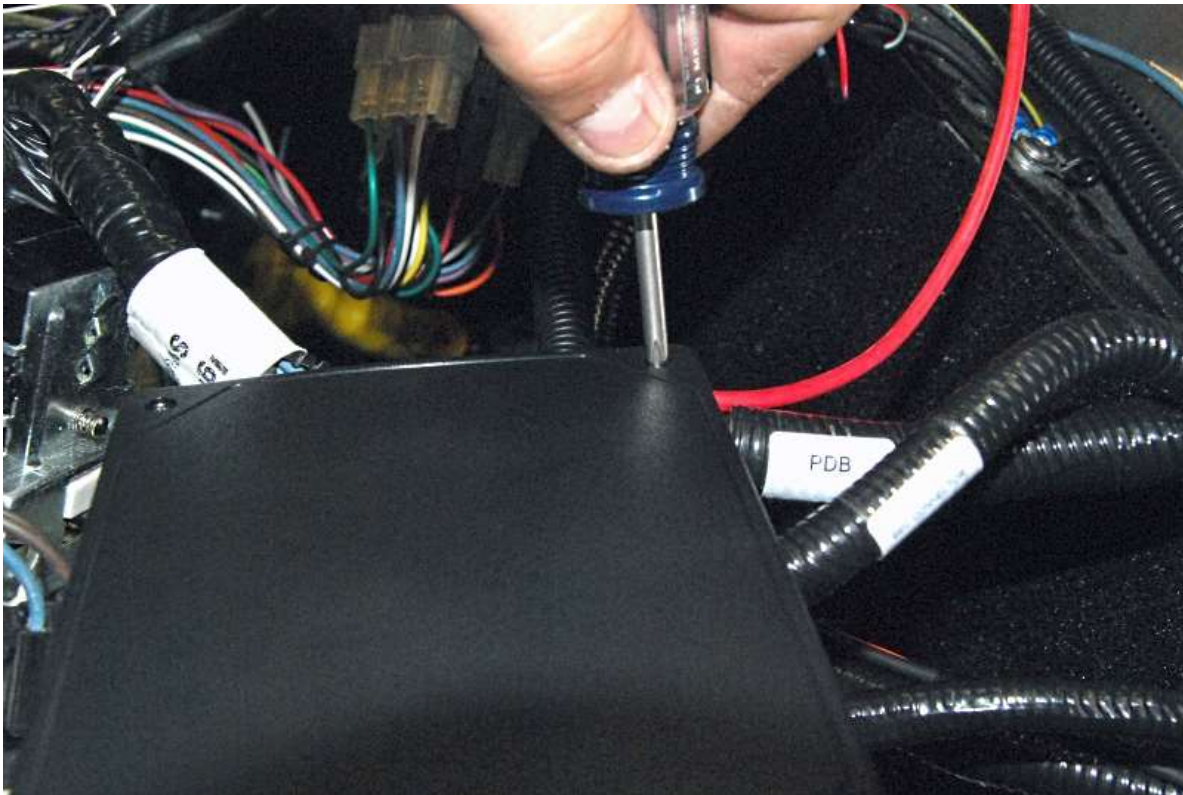

Reattach the top of the box.

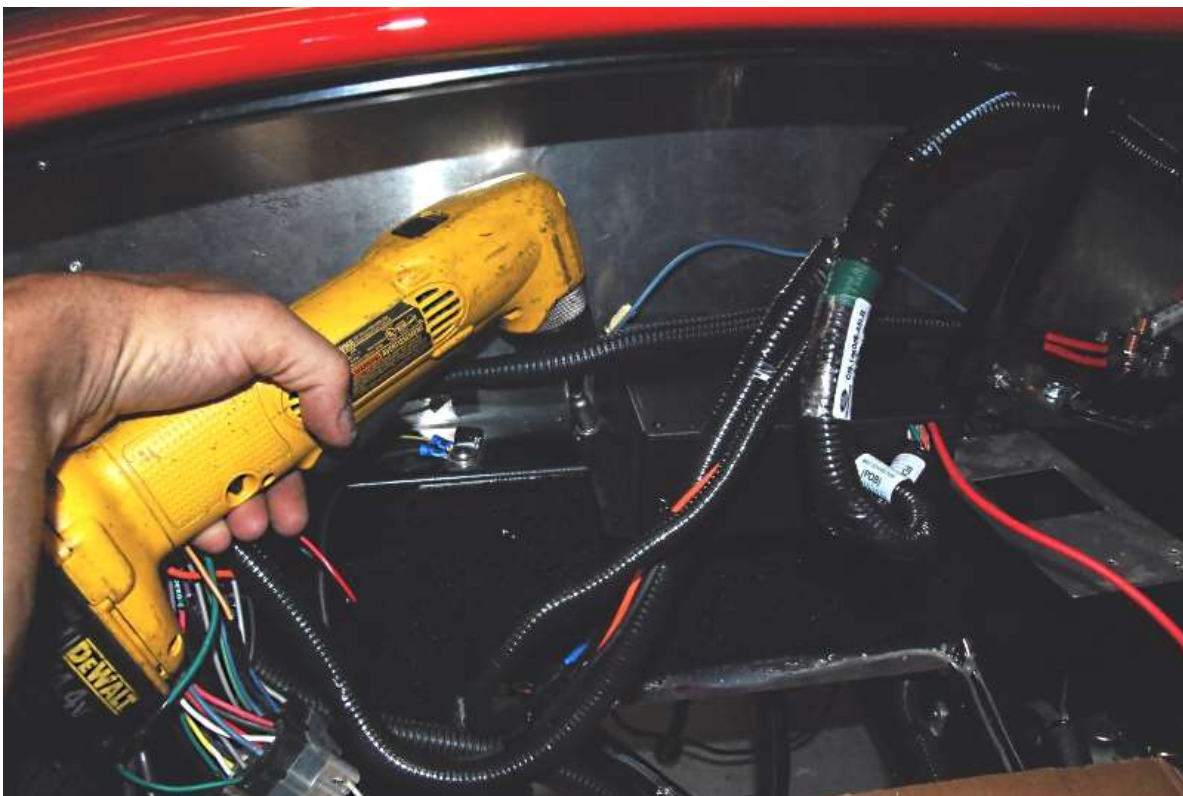

Attach the box to the frame.

Power Distribution

- ✂ Wire cutters/strippers, electrical tape, wire crimpers.

- 👉 We used an extra starter solenoid for power distribution in these instructions. A distribution post is provided in the Coyote kit.
- 👉 The solenoid on the starter is the one being used to start the engine.
- 👉 2011-2014 only

Locate and attach the power distribution post to the 2"x 2" tube.
Shorten and attach the red wire from the black box to the power distribution post using one of the yellow ring connectors.
Attach a ring connector to the 10 ga red wire.
Attach the 10 ga wire ring connector to the post.
Run the 10 ga wire to the battery side of the starter solenoid on the engine.
Cut the wire to length and attach another yellow ring connector.

OBD 2 Port



Locate the OBD 2 port on the 2"x 2" tube to the right of the steering wheel.



Use some of the aluminum panel #6 screws to attach the OBD 2 plug to the frame.

General

✂ Wire cutters/strippers, electrical tape

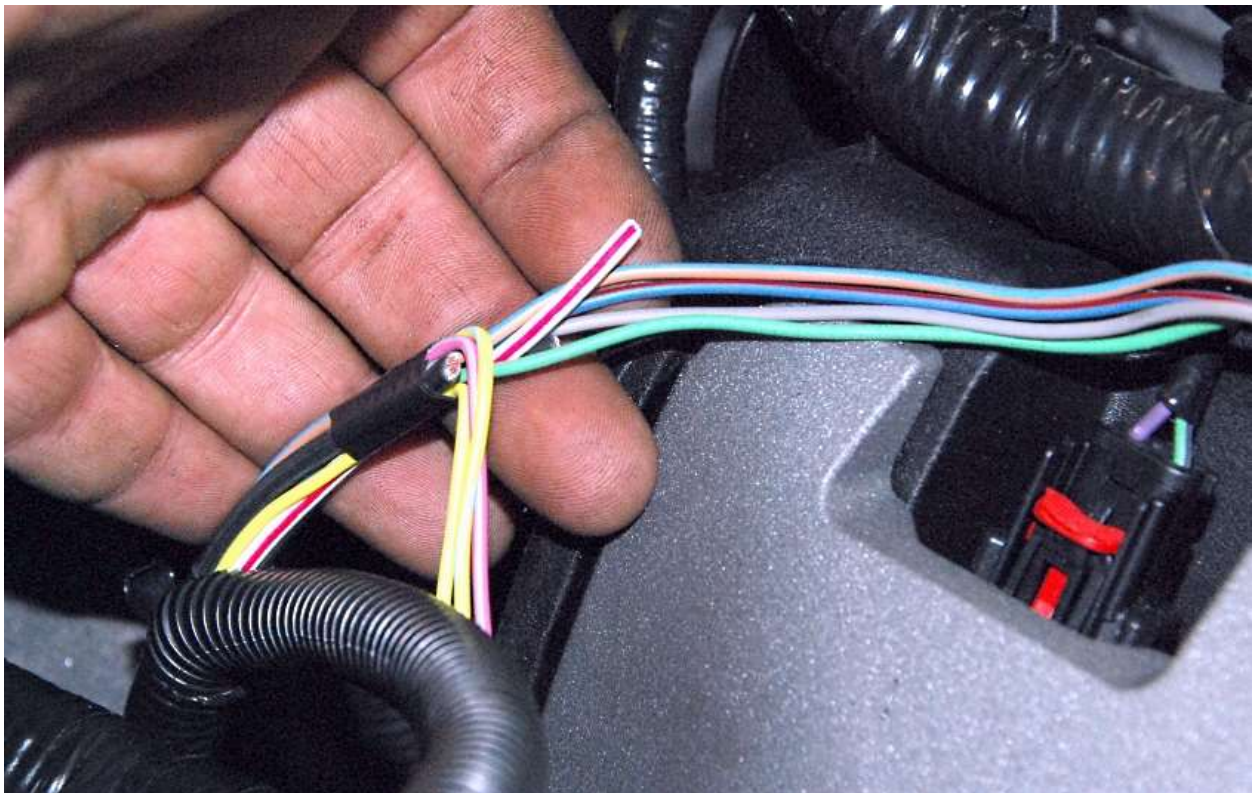

Cut the white/red Intercooler pump wire as far back in the harness as you can. It is not needed or used.

Attach the accelerator plug to the accelerator pedal.



Push the mass air plug onto the mass air meter.

Exhaust

✂ 15mm, 17mm sockets, 15mm wrench

🔧 Coyote headers, straight pipes

👉 **The threads in the heads for the headers changed a couple times during production Be careful when installing the headers bolts so the threads are not ruined. After removing the headers studs, compare the thread to the new header bolts.**

Production header bolt change dates:

From 3-22-10 to 9-8-10 M10 x 1.50 Coarse

From 9-8-10 to 1-18-11 M10 x 1.25 Fine

From 1-18-11 M10 x 1.50 Coarse

FFR supplies the course bolts only. If the fine thread bolts are needed, the specifications you require when you purchase the bolts are: M10 x 1.25mm x 25mm long grade 8.8 hex head bolt

👉 Insert and tighten all of the bolts by hand before tightening any with a wrench.

Attach the headers to the engine.

Attach the connector pipes to the headers and kit exhaust system.

Starting the engine

🚗 Oil, Coolant

If not already done, fill the engine with 8 quarts of the correct oil.



If not already done, fill the engine with coolant through an inline filler or radiator cap. To help remove air from the system, remove the top cap until coolant starts going up the tube then recap and hose clamp.

Fill the coolant overflow container.

Set the Fuel pressure regulator to the correct pressure as described in the Ford Racing engine control instructions.

Start the engine and allow the engine to get up to 195°F- 200°F then allow to cool completely, it will suck coolant from the overflow.

👉 Cooling fan is switched on at 195°F, turns off at 190°F. This is based on inferred engine coolant temperature. Engine coolant temperature is inferred from the cylinder head temperature. Inferred coolant temperature may not be the same as actual coolant temperature.

Once cool, check the radiator/inline filler neck and coolant overflow container. Top up with coolant if necessary.