

Part Number: 33871

Revision: X

Effective Date: 04/17/19

By: J. INGERSLEV

Document Type (indicate):

Bill of Material

Drawing (may be attached)

Specification

**Assembly Instructions**

Operating Procedure

Other

# Hot Rod Coyote Engine

## Installation Instructions



Parts needed .....	3
Ford Performance Parts.....	3
Ford Motor Co. Parts .....	3
Summit Racing .....	3
Fuel System.....	3
Oil Filter Relocator .....	3
Air Intake System.....	4
Other vendors.....	4
Autozone .....	4
Supplies.....	4
Information.....	4
Engine Prep.....	5
Exhaust.....	5
Oil Pressure sender.....	5
Oil Cooler Spacer.....	6
Oil filter relocater.....	9
Water Temp Sender .....	13
Oil pressure sender.....	17
Engine Bolts.....	18
Alternator Boss .....	18
CMCV removal.....	20
Clutch Fork .....	23
Engine/Transmission Installation .....	24
Fuel System.....	26

Fuel pressure regulator .....	27
Fuel lines .....	28
Fuel pressure regulator vacuum.....	29
Oil filter Relocator .....	31
Cooling system.....	32
Air Intake .....	40
Mass Air Meter .....	40
Intake tube.....	45
Spectre MAF Sensor .....	45
Treadstone MAF Sensor .....	47
Vacuum ports and PCV vent.....	49
Valve cover hoses .....	50
Steering shaft.....	52
Wiring .....	54
Cockpit.....	55
16-way Pigtail .....	55
Engine bay.....	56
Computer.....	56
Mass Air Meter .....	58
Fuel Pump .....	58
Clutch position switch.....	60
Radiator Cooling Fan .....	64
Power/start .....	66
Tach .....	71
Oil Pressure and Water temp sensors .....	75
OBD 2 Port .....	76
Clutch cable.....	77
Starter Solenoid.....	78
O <sub>2</sub> Harness.....	80
Intercooler wire .....	82
Power Distribution .....	82
Gauges.....	82
Tach .....	82
Water Temp Sender .....	83
Oil Temp sender.....	84
Alternator .....	86
Wiring .....	92
Accelerator Pedal .....	96
Exhaust.....	100
Starting the engine.....	101

## Parts needed

### Ford Performance Parts

M-6007-M50A - 5.0L Engine  
M-6017-A504V – 5.0L engine control pack  
M-7003-R58C - TKO transmission  
M-7771-A – Bellhousing bolt kit  
M-9680-M50 – 5.0L engine cover kit  
M-7007-A – Transmission Sandwich plate  
M-6392-M46 - Bellhousing  
M-7560-T46 – Clutch kit  
M-7515-A – Clutch fork  
M-6375-G46A – Flywheel (If not already on engine)  
M-7548-A – Clutch Release Bearing or Ford motor F7ZZ.7548.AA  
M-6397-B46 – Clutch bolt kit  
M-7600-B – Pilot bearing (If not already on engine)



### Ford Motor Co. Parts

F3LY-6C070-A – Flywheel access hole plug  
BR3Z-8260-BA – Mustang upper radiator hose – If not included with control pack  
GR3Z-11002-A – 2016 Mustang Starter  
W500310.S438- Starter bolts (3 needed)  
BR3Z-6379-A – Flywheel bolt (8 needed)  
AL3Z-6890-A – 2015 & newer only - Oil filter nipple to eliminate oil cooler spacer plate.

## Summit Racing

### FUEL SYSTEM

- ✎ Ford Performance does not recommend the Corvette fuel filter/pressure regulator
- ✎ An alternative to buying all these items is the FFR 34423 EFI Inline fuel system

AEI-13129 – 6AN Fuel pressure regulator  
SUM-220166B – 6AN O-ring to straight 6AN Adapter (2 needed)  
SUM-220701-B – 6AN to -6AN Hose Barb (1 needed)  
FRA-495110-BL – 6AN O-ring to straight -4AN Adapter (1 needed)  
SUM-220700-B – 4AN Hose Barb (1 needed)  
SUM-220711-B – 90° -6AN to -6AN Hose Barb (1 needed)  
SUM-800199 – 0-100 EFI fuel pressure gauge  
GSL392BX – Fuel Pump  
VPN-400-939 – Fuel pump mount/barbs for GSL392BX pump

### OIL FILTER RELOCATOR

- ✎ If using electric steering, these are needed. The oil filter will not clear the steering joint.

MMR 403335 – 5.0 Coyote Oil filter relocator kit

## AIR INTAKE SYSTEM

👉 Two possibilities

SPE-9741 – 4” to 3.50” Reducer adapter

SPE-9771 - 4” hose coupling

SPE-9799 - 4” 90 ° intake tube – Requires putting fitting in hose for PCV hose

SPE-9705 - Mass Air Sensor filter adapter

KNN-RU-5149 – 4” ID x 6.50” long Air Filter

Or use

[www.treadstoneperformance.com](http://www.treadstoneperformance.com) – MAPHL35

FFR 16404 - 90° Silicone hose with fittings

FFR 16608 -air filter

## Other vendors

### AUTOZONE

Short oil filter (if not using Electric steering) - Fram PH10060 or Mobil M1-113 or STP S10060

👉 If running electric steering, an oil filter relocater with a M22 threaded spin on adapter is needed.

👉 If not running A/C, a small 1-wire alternator can be used in the stock compressor location. If A/C is being used, the following alternator can be used with the brackets described.

2001-03 Honda Civic DX 1.7L MFI SOHC Alternator – 12308

Hoses and fittings for Vacuum lines

Autometer Tach Adapter 9117 (Only if using Autometer Gauges)

## Supplies

Oil – See instructions with engine - 8 quart

Coolant –2-3 gallons of **Dex-Cool concentrate**

Transmission fluid

Teflon tape

## Information

These instructions assume that the customer has the Coyote Installation kit from Factory Five Racing. Make sure to download the latest version of the engine controls instructions from the Ford Performance parts website: [www.performanceparts.ford.com](http://www.performanceparts.ford.com) . Do a parts search for: M-6017-A504V and click on the instructions pdf.

Use the following diagram as a guide for harness locations.





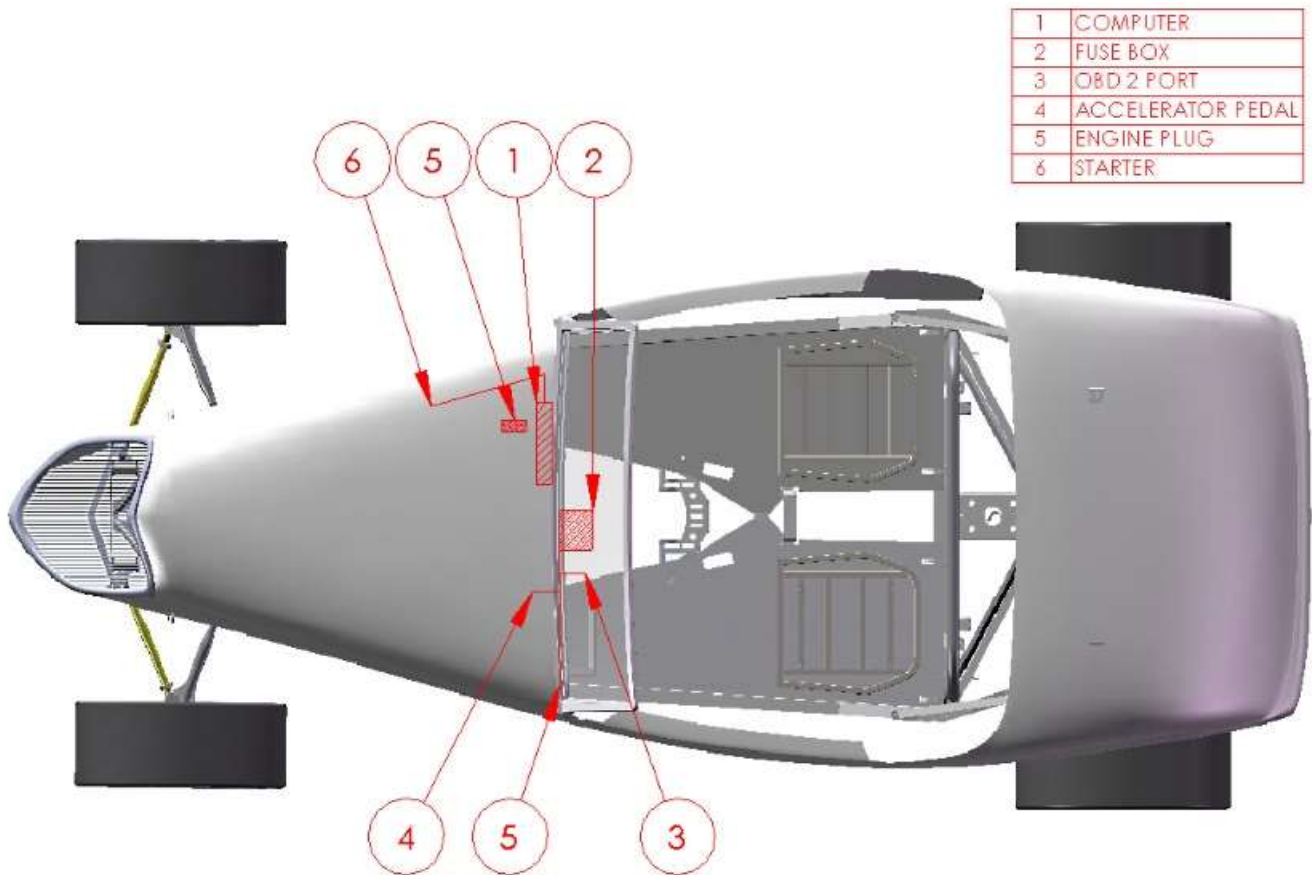



## Engine Prep

### Exhaust

Remove the Stock Mustang headers.  
 Remove all of the header studs using a 6mm 6 point socket.



### Oil Pressure sender

-  Pipe fittings, Gauge assembly
-  11/16", 7/8" wrenches



Remove the stock oil pressure gauge sender plug from the block located on the left front side of the engine. This plug will not be used again.

## Oil Cooler Spacer

-  H14 Hex key, ratchet
-  If Running Electric steering, an oil filter relocation kit will be needed. The oil filter will not clear the steering joint



Place a bucket or container to catch oil under the filter and remove the oil filter. This filter is too long and will not be used again.



Use an H14 hex key to remove the oil filter nipple and cooler. These will not be used again.





Insert the AL3Z-6890-A oil filter nipple.



Use the H14 hex key to tighten the nipple in the block.



The oil pressure sender will get installed after the water temp sender is installed.

## Oil filter relocater

- ✂  $\frac{3}{8}$ " Hex key, 8mm socket, ratchet, Teflon tape, ratchet extensions,  $\frac{7}{8}$ " wrench, vise grips, Pipe fittings, oil filter relocater.
- 👤 If Running Electric steering, an oil filter relocation kit will be needed.
- 👤 The filter on the engine has a metric thread while the FFR relocater does not.
- 👤 Do not use the spin-on adapter in the relocater box, it has the wrong thread. Use the spin-on adapter from Permacool.

Remove the oil filter that comes on the engine and discard.



Put the o-ring in the relocater groove and screw the spin-on adapter onto the block.



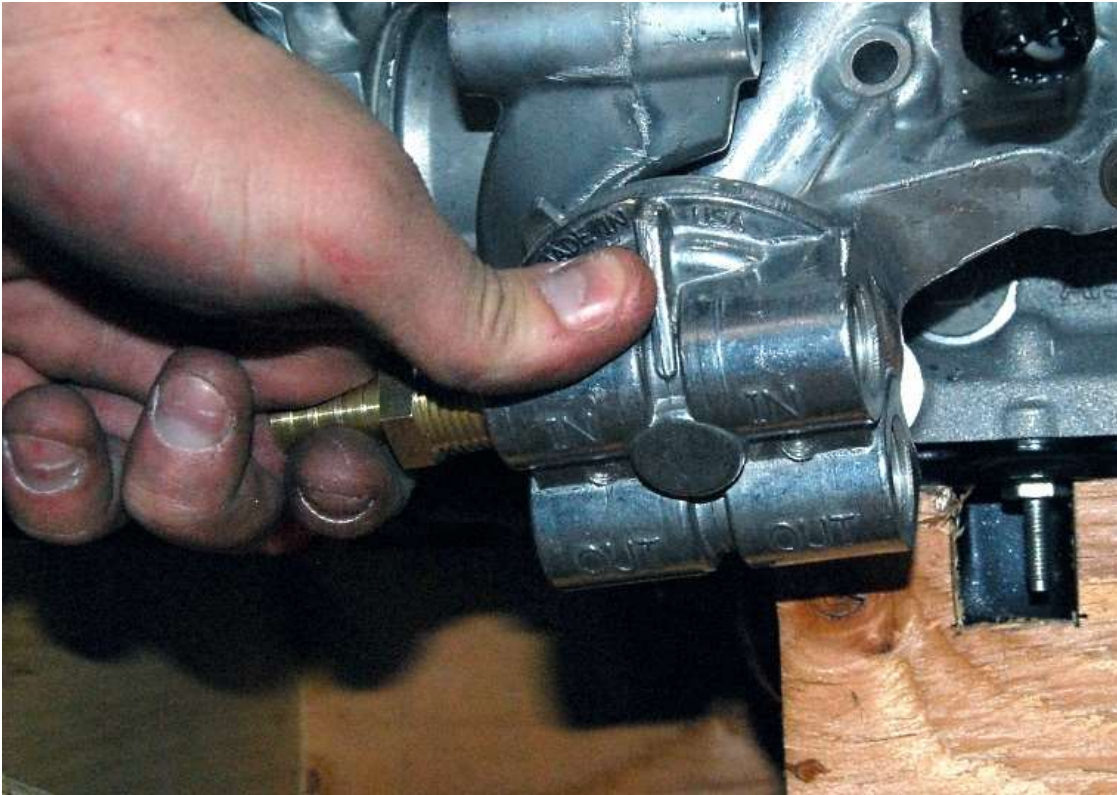

Use one of the hose adapters to turn the relocater if necessary so that the spin-on adapter is oriented front to back.



Use Teflon tape on the port plugs. Screw the plugs into the back side of the spin-on adapter.



Use Teflon tape on the hose fittings.

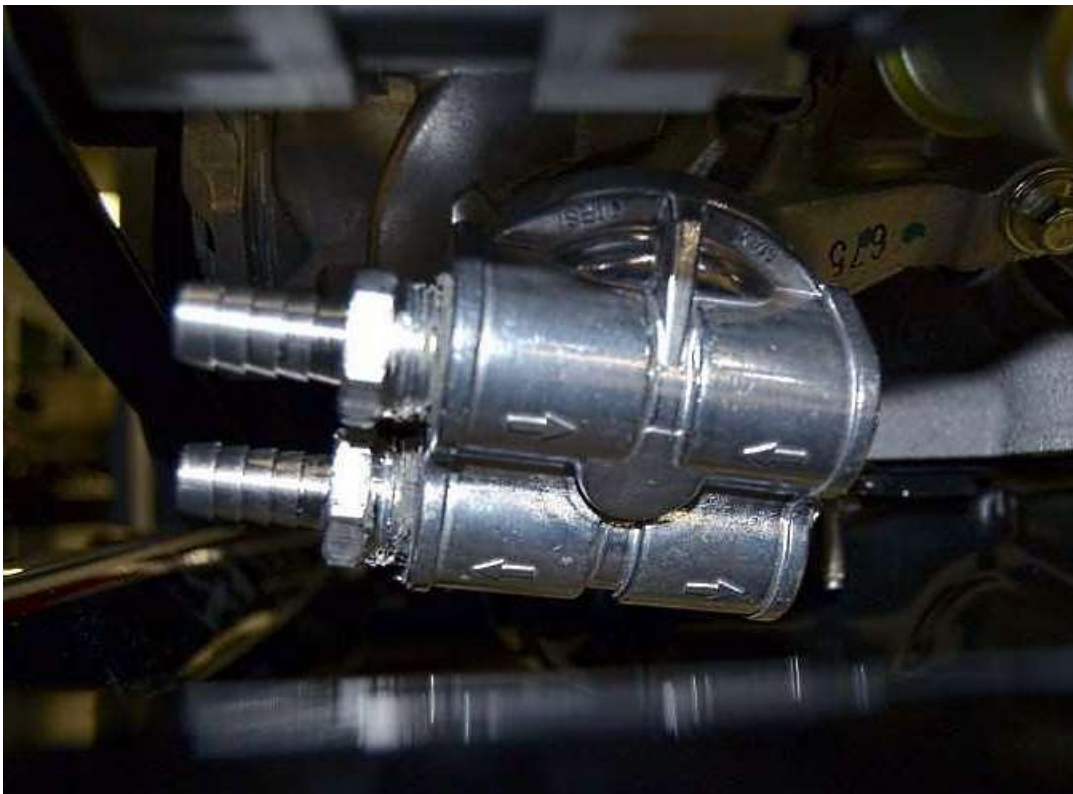

Screw the hose fittings into the front of the spin-on adapter.



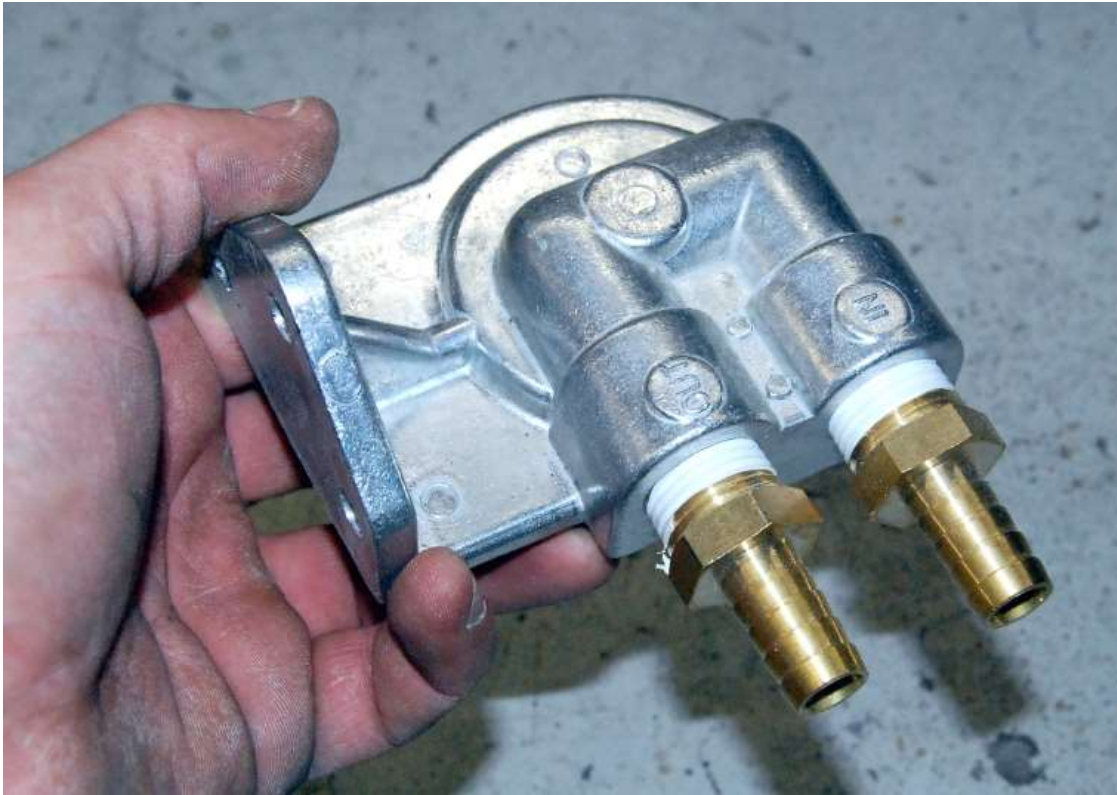

Screw hose fittings into the relocater.



Screw the threaded nipple into the relocater.



## Water Temp Sender

- ✂ H14 Hex key or socket,  $1\frac{1}{16}$ " socket,  $\frac{7}{8}$ ", 12mm deep socket, extension, ratchet, Teflon tape
- 🚗 Water temp gauge sending unit.
- 👤 Autometer gauge sender shown, similar install for Vintage gauge sender.





Remove the  $\frac{3}{4}$ " NPT plug from the side of the block using a H14 Hex key.



Use Teflon tape on the  $\frac{1}{8}$ " NPT to  $\frac{1}{2}$ " NPT adapter included with the gauge.



Use a vise to hold the large  $\frac{3}{4}$ " to  $\frac{1}{2}$ " NPT adapter then use a  $\frac{7}{8}$ " wrench to put the two adapters together.



Screw the adapter into the block using a  $1 \frac{1}{16}$ " socket.





Screw the adapter into the larger adapter on the block.



Put Teflon tape on the sending unit Autometer top



wrench to screw the sender into the adapters.

## Oil pressure sender



Screw the oil pressure sender and adapter into the block and tighten.



## Engine Bolts

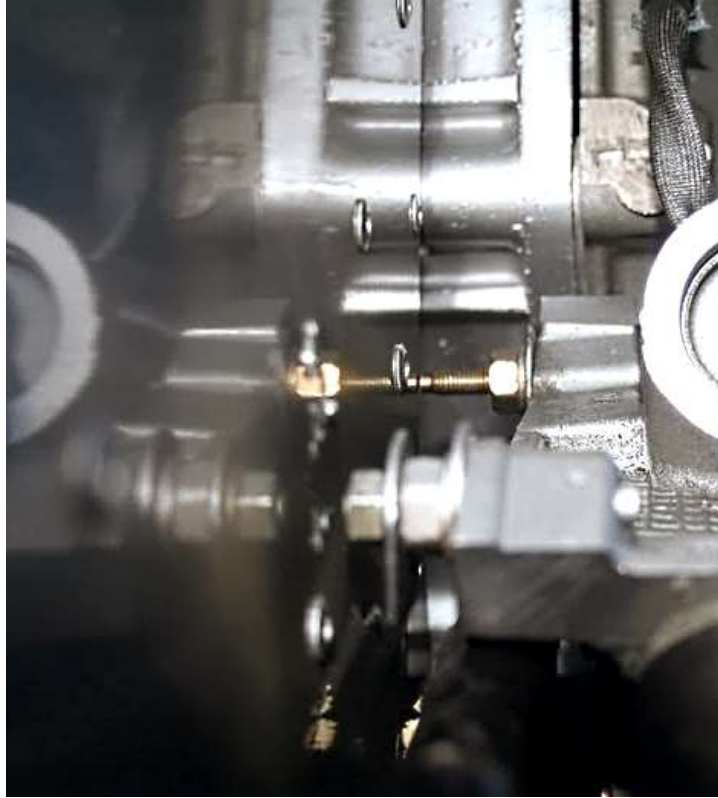

The engine ends up extremely close to the firewall. Cut any extra length off the bolts sticking out the back of the engine to prevent damaging the firewall.

## Alternator Boss

- ✂ Hack saw or jig saw
- 👤 Use a hack saw or sawzall with a course wood blade, a fine metal blade will get gummed up with the aluminum.





Use a Marker to mark the top stock alternator boss on the driver side as shown. It will hit the frame otherwise.



Cut the boss on the line marked with a jig saw.

## CMCV removal

- ☞ Charge Motion Control Valve - These valves introduce tumble and swirl into the airflow at part throttle, maximizing combustion efficiency.
- ☞ The coyote install in the Hot rod is very tight against the firewall, the new CMCV's stick out past the back of the block and therefor need to be disabled.

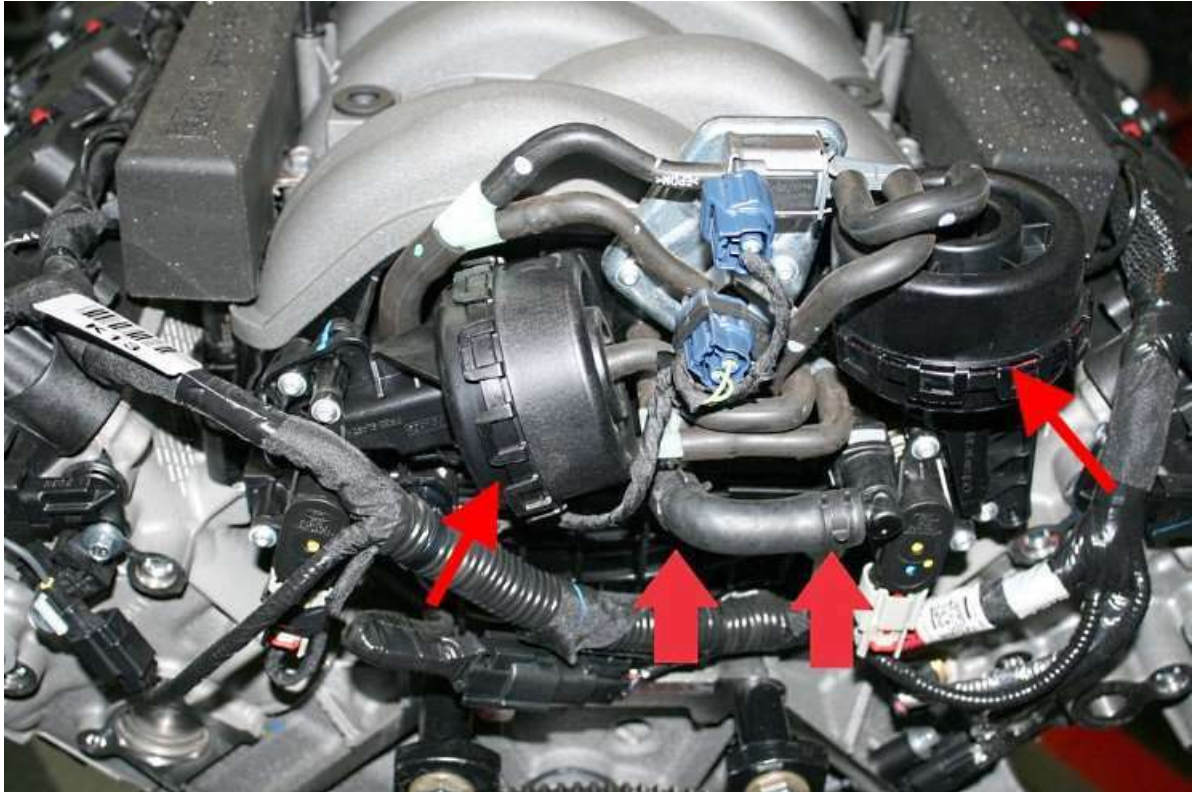

The CMCV actuators and PCV tube.





Remove the CMCV actuators and block off the vacuum feeds.



Shorten the end of the vacuum nipple with the hose on as much as possible to prevent the tube from hitting the firewall as shown.



Cap the vacuum nipple above the just shortened.





When standing in behind of the engine, the left side CMCV shaft needs to be rotated counterclockwise and locked in position.





When standing in behind of the engine, the right side CMCV shaft needs to be rotated clockwise and locked in place with a zip tie.

## Clutch Fork

-  3/4" socket, ratchet
-  Transmission, Polyurethane engine/transmission mount kit
-  The two aluminum spacers provides are not used.

If not already done, install the flywheel and clutch on the engine.



If the clutch fork has a vibration damping weight on it, remove it from the clutch fork, it is not needed.

Attach the bellhousing and clutch fork to the engine.

Attach the transmission to the engine.

## **Engine/Transmission Installation**

If electric steering is installed, undo the mounting bolts and rotate the motor down out of the way.



Install the engine and transmission per the assembly manual.





Attach the polyurethane transmission mount to the frame mount and transmission using the 1.09" and 0.32" spacers provided.





If using electric steering, reattach the motor mounting bolts. Make sure there is some clearance between the oil pan and motor. Redrill/slot one or two of the mounting holes if necessary.

## Fuel System

-  Fuel pressure regulator, fittings, fuel hose, hose clamps, high pressure fuel pump
-  The Coyote engine requires a 255 lph high pressure fuel pump such as a Walbro GSL 392 Fuel Pump or use the FFR inline Fuel system..

## Fuel pressure regulator



Mount a fuel pressure regulator to the firewall and connect the appropriate fittings, the return is on the bottom.

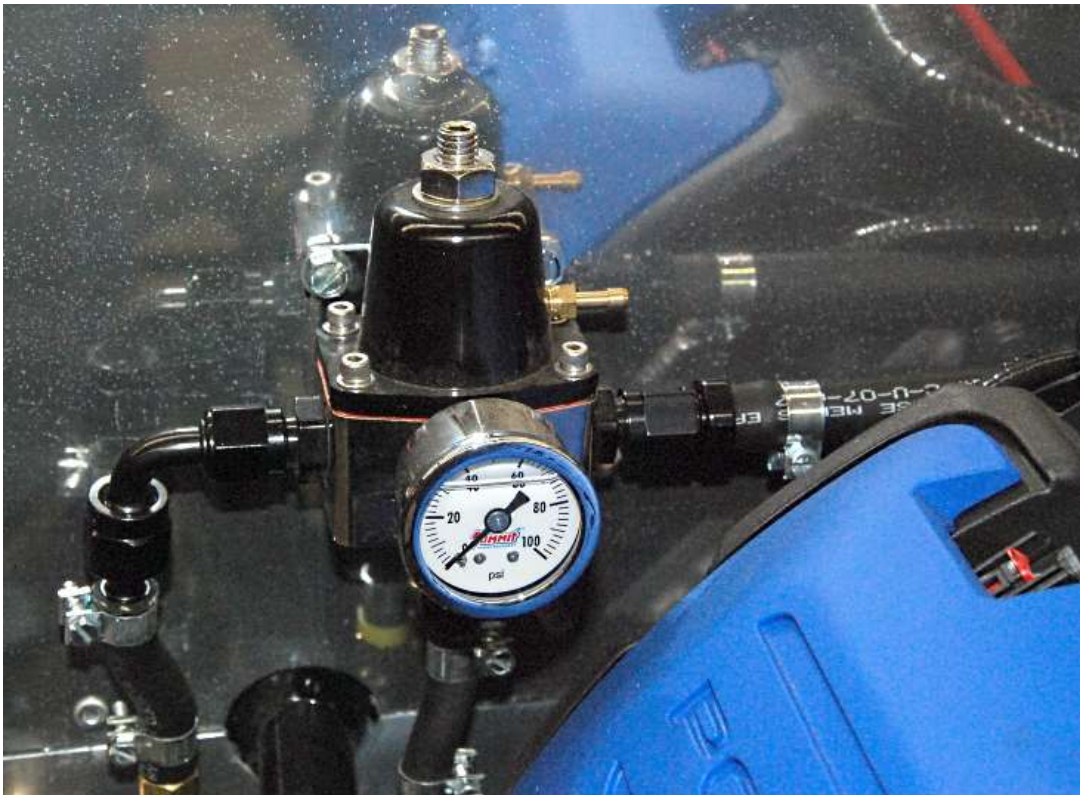

Push the  $\frac{3}{8}$ " fuel line onto the right side of the regulator then attach a hose clamp and run it over to the engine fuel rail.

## Fuel lines

Push the white fuel line connector onto the fuel rail.

Hold the fuel line up to the connector and cut it to length with a razor knife.

Remove the fuel line connector.

Slide a hose clamp onto the hose then push the fuel line connector into the hose and tighten the clamp.



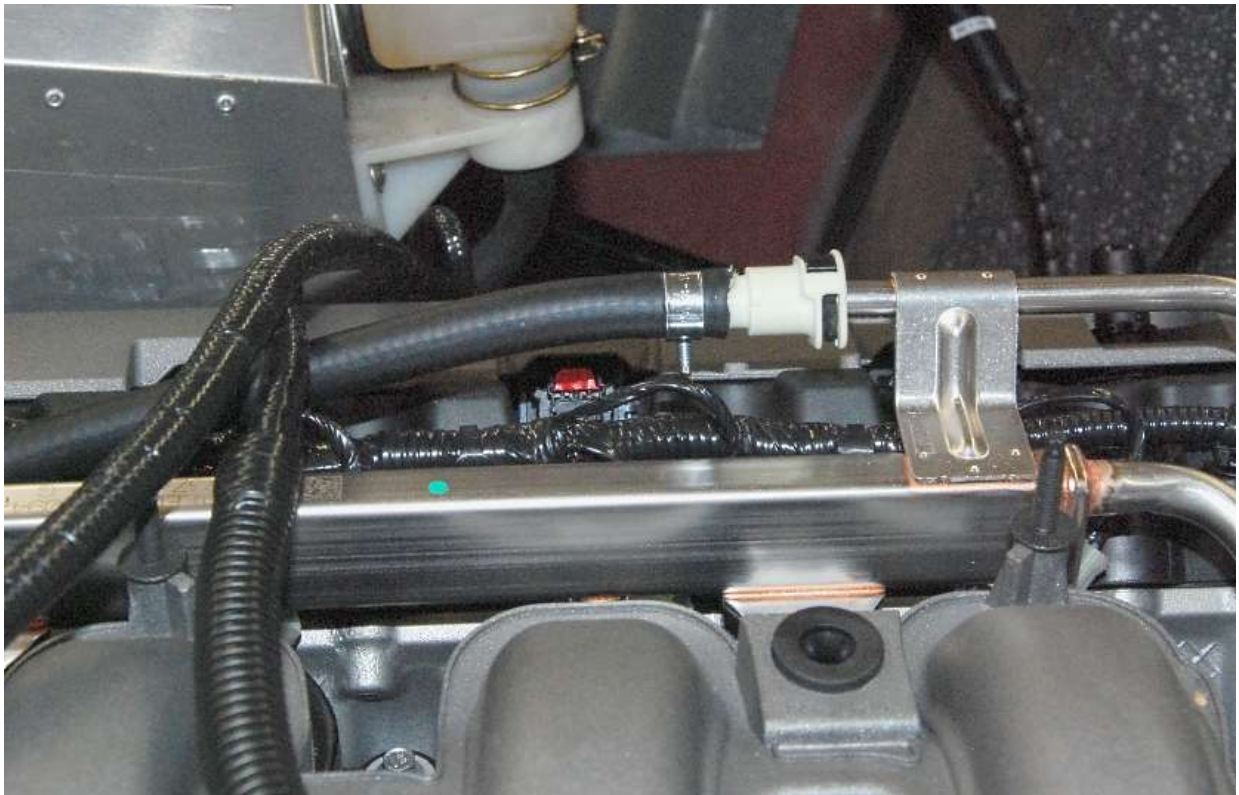

Push the white connector onto the fuel rail.

### **Fuel pressure regulator vacuum**

Cut a 2.50" section from the length of 1/2" hose provided.



Assemble the 1/2" to 5/32" 90 degree adapter.

Push the ½” side into the short section of ½” hose and fasten with a hose clamp.  
Slide a second hose clamp onto the hose.  
Push the vacuum line onto the hose adapter.



Push the ½” hose onto the vacuum port on the right side of the throttle body so the small end points towards the firewall and tighten the hose clamp.





Run the vacuum line to the fuel pressure regulator and push it onto vacuum barb.

## Oil filter Relocator

👉 This is only needed if running electric steering



Locate the filter relocator under the steering rack or a similar place to allow a straight shot for the hoses to the filter spin-on adapter.

## Cooling system

- ✂ Razor knife, flat head screwdriver, wire cutters, hack saw, marker,  $\frac{5}{16}$ " socket, ratchet.
- 🔧 Stainless radiator hose kit



Push the correct size adapters onto to the thermostat housing with a length of the stainless hose.





Route the stainless hose to the left side lower radiator outlet and mark the hose for cutting.

Remove the stainless hose and cut it where marked with a hack saw.  
Reinstall the hose.



Cut the plastic clamp off the stock upper hose.



Cut and remove the rubber hose from the plastic adapter.



Attach one of the kit hose adapters to the plastic adapter





Push the adapter onto the engine.



Attach another hose adapter to the radiator.





Route and cut the radiator hose so that the hose curls towards the right side of the car not the left (the air filter goes there). Push the bypass caps onto the tubes to the left of the throttle body and hose clamp the lower one.

- ✎ For air bleeding later, remove the top cap until coolant starts going up the tube then recap and hose clamp.
- ✎ This top one is one of the heater core hose locations if running a heater and A/C.

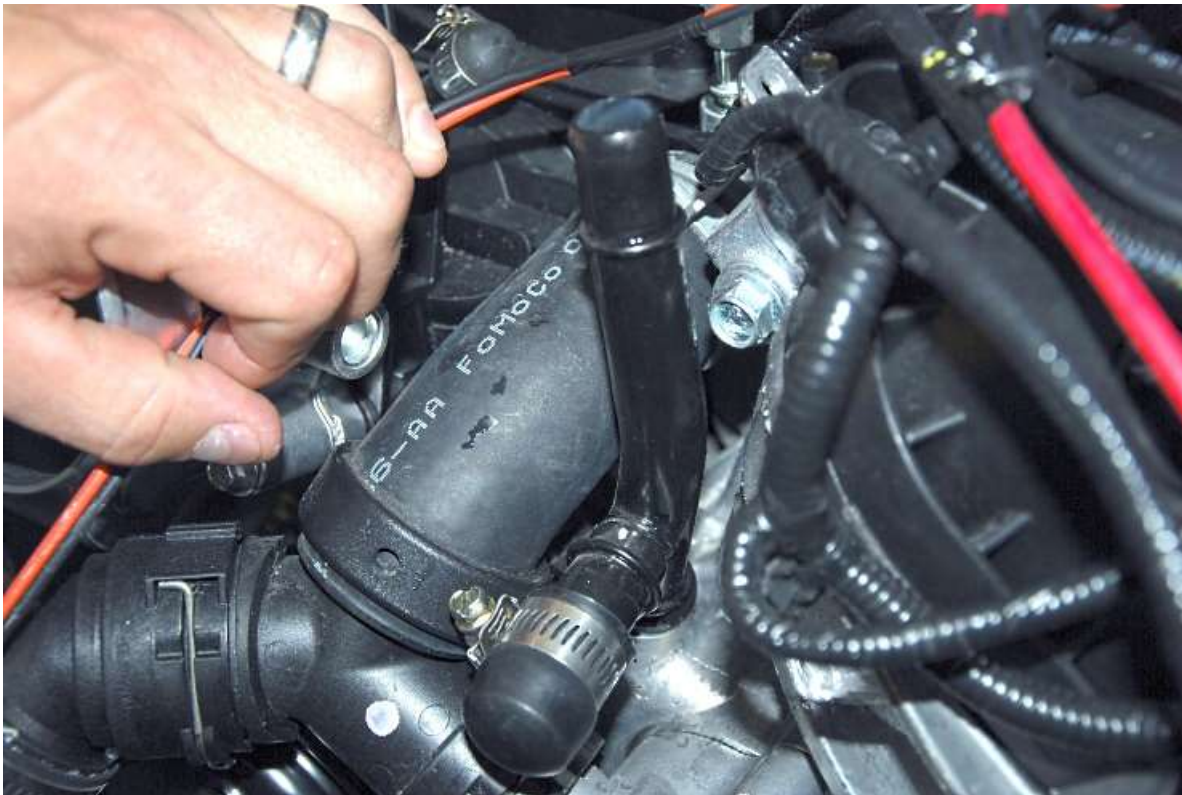

Push the bypass caps onto the lower tube to the left of the throttle body and hose clamp it.

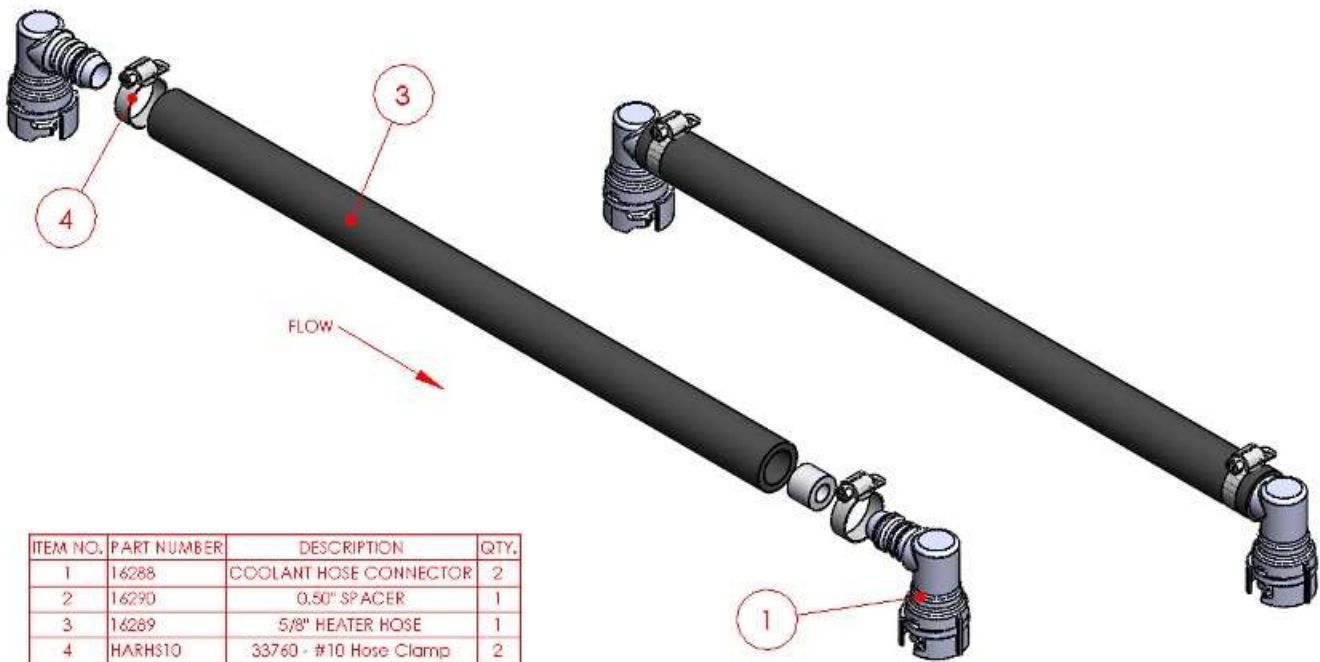

Assemble the right side of the heater bypass hose, insert the 0.50" aluminum spacer into the 5/8" heater hose followed by a hose clamp then push one of the 90° plastic coolant hose adapters.

Tighten the hose clamp using a 5/16" socket and ratchet.





Push the hose onto the top of the tube to the left of the throttle body.

Push the other adapter onto the tube on the right side of the intake then measure and cut the  $\frac{5}{8}$ " heater hose so that it will connect to the adapter and route where desired.



Put a hose clamp on the hose, push it onto the coolant adapter and tighten the hose clamp.



- ✎ For air bleeding later, remove the 90° plastic coolant hose adapter until coolant starts going up the tube then recap and hose clamp.
- ✎ This top one is one of the heater core hose locations if running a heater.



Push and hose clamp the small coolant barb behind the 3/4" coolant tubes.



Cap and hose clamp the 3/4" coolant.



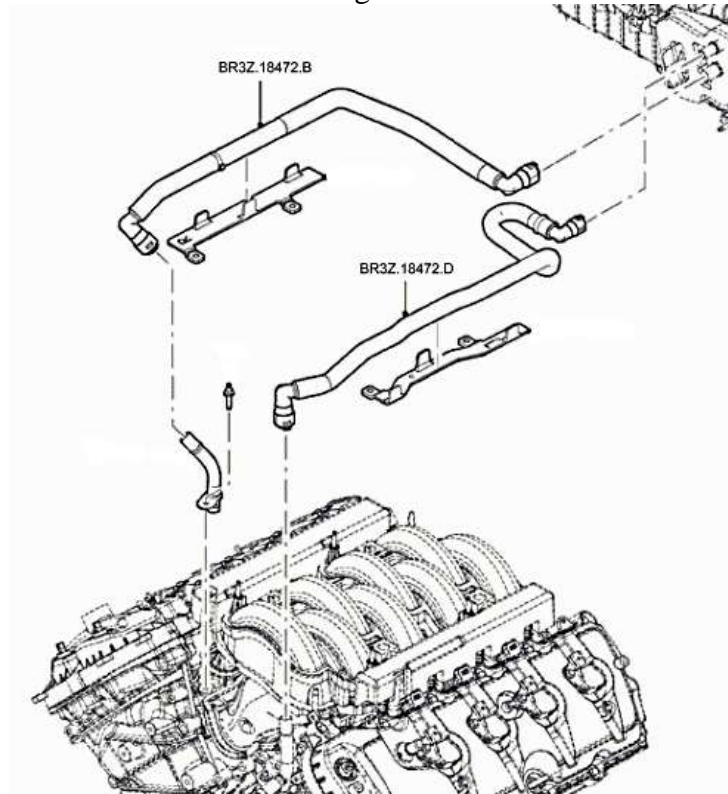

This is the other heater core location if running a heater.



If running a heater or A/C, use the bypass hose connectors and some heater hose to connect to the heater.

## Air Intake

### Mass Air Meter

-  Mass air meter, silicone hoses, intake tubes, air filter
-  T-20 Torx driver, Flat head screwdriver, Philips head screwdriver, sensor safe RTV silicone
-  These instructions show the Spectre parts. For the Treadstone MAF tube, make sure the Mass Air meter is pointed in the correct direction.





Unscrew the mass air sensor from the Ford intake using a T-20 Torx driver



Remove the sensor and note the direction of the curved part of the sensor.





Install the rubber ring into the intake mount.

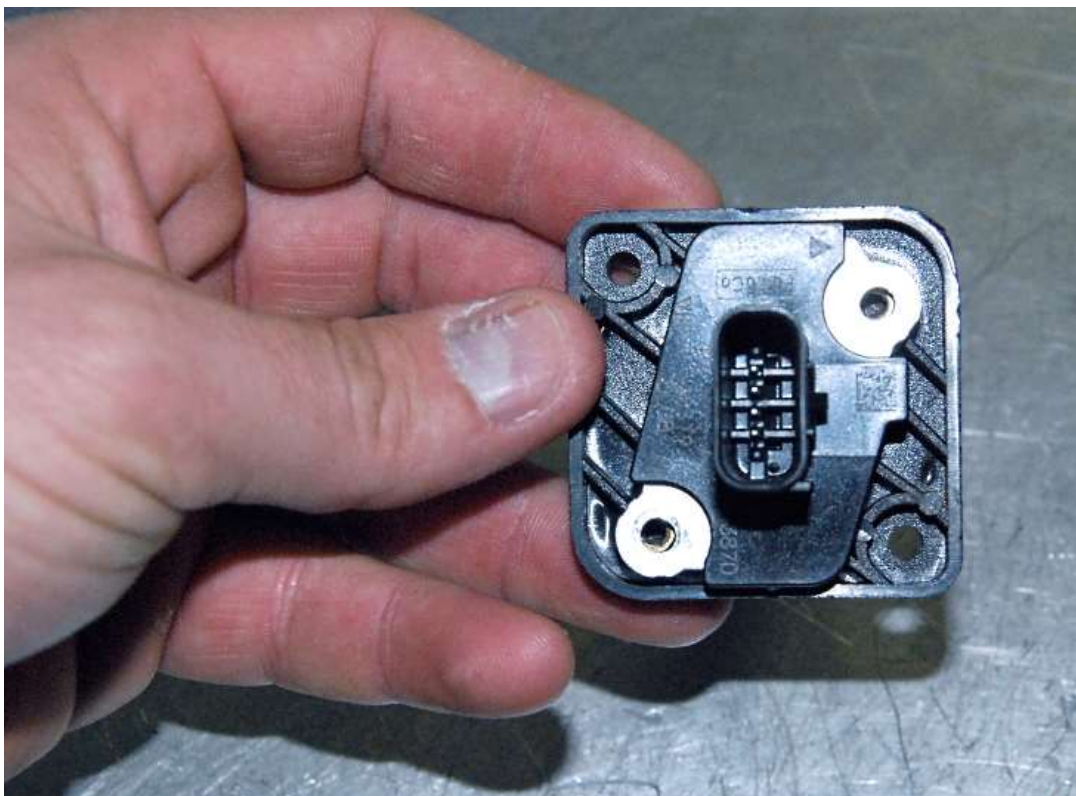

Insert the sensor into the mount to determine which way around it needs to go so the sensor mount holes will line up and the sensor will mount the correct way.



Attach the mount to the intake tube using the long screws so that the flat side of the sensor will face the “Spectre” writing.

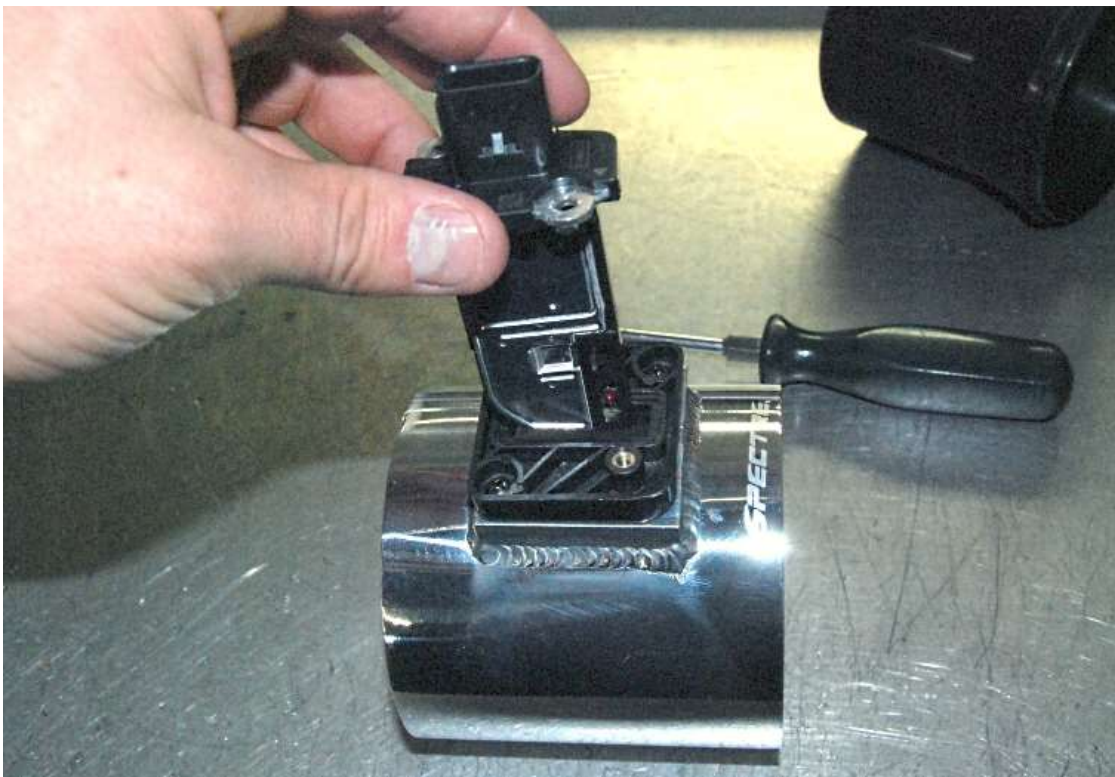

Install the sensor on the mount using the short screws so the flat side of the sensor will face the “Spectre” writing.





Run a bead of Sensor safe RTV silicone around the flange of the large plastic reducer.



Slide the Mass Air Meter tube flat sensor side first (Spectre writing) down onto the plastic reducer.

Wipe any excess RTV off the tube.





Turn the mass air meter over so the Reducer is on the top and let the RTV dry overnight.

## **Intake tube**

### **SPECTRE MAF SENSOR**



Slide the Mass Air Meter tube flat sensor side first (Spectre writing) into the air filter.



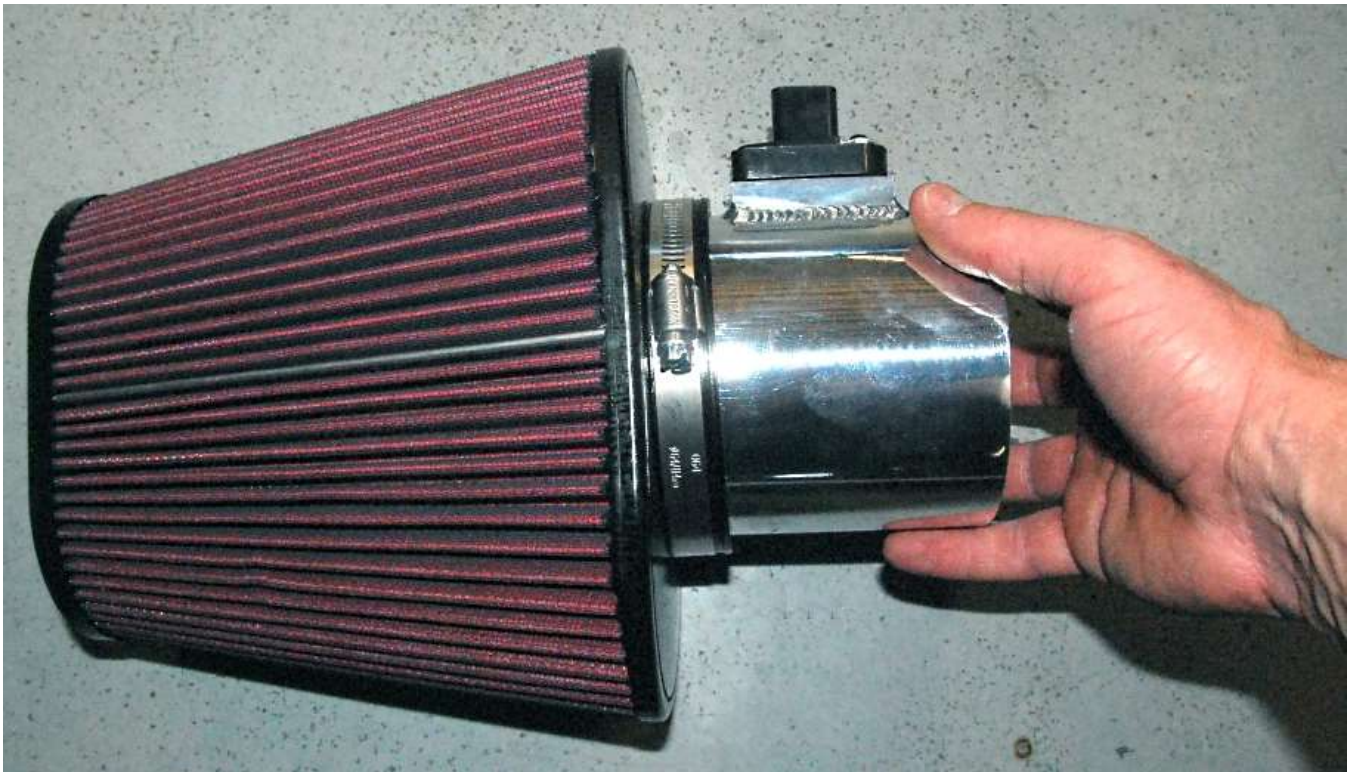

Adjust the Mass air meter so that the mass air plug is on the far side as the Ford Racing instructions recommend.



Tighten the hose clamp.

Connect the elbow tube to the mass air meter using the silicone connector; only tighten one of the hose clamps right now.

Attach the silicone reducer to the tube elbow.



Push the intake tube onto the throttle body and position the air filter under the hood hinge. Tighten the hose clamps.



### TREADSTONE MAF SENSOR



Push the FFR filter onto the Mass Air meter making sure that the meter is facing the correct direction.

Slide hose clamps onto the 90° Silicone hose.



Test fit the 90° Silicone hose on the mass air meter and the throttle body.

Adjust the Mass air meter so that the mass air plug is on the far side as the Ford Performance instructions recommend.

Tighten the hose clamps





Push the mass air plug onto the mass air meter.

## Vacuum ports and PCV vent

- ✂ Flat head screwdriver, razor knife, WD40
- 🚗 Vacuum plugs, PCV lines, ½" rubber hose, T connector



Block off the vacuum ports and fuel evaporator intake tube just behind the throttle body.

## Valve cover hoses



If not already done, connect the right side stock PCV hose from the valve cover to behind the throttle body.





Attach the Right PCV fitting to the left side valve cover.



Attach the other end of hose to the intake hose.

Block off the other intake tube fitting.

## Steering shaft

- ✂ Hack saw,  $\frac{7}{16}$ " socket, ratchet,  $\frac{3}{16}$ " drill bit, drill,  $\frac{3}{16}$ " hex key
- 🛠 Hot Rod steering parts

Remove the middle steering shaft that goes from the firewall to the lower steering bearing in the engine bay. Cut the shaft into two sections,  $8\frac{7}{8}$ " for the lower shaft and 4.25" for the upper shaft. Assemble the two shaft pieces with the included steering joint with the short half of joint on the long shaft. Slide the  $\frac{3}{4}$ " pillow block onto the long shaft with the bearing lock pointed away from the steering joint. Assemble the shaft on the frame so that the ends of the shafts are flush with the inside of the joint. Loosely attach the tube clamps to the 1" round tube near the steering shaft.

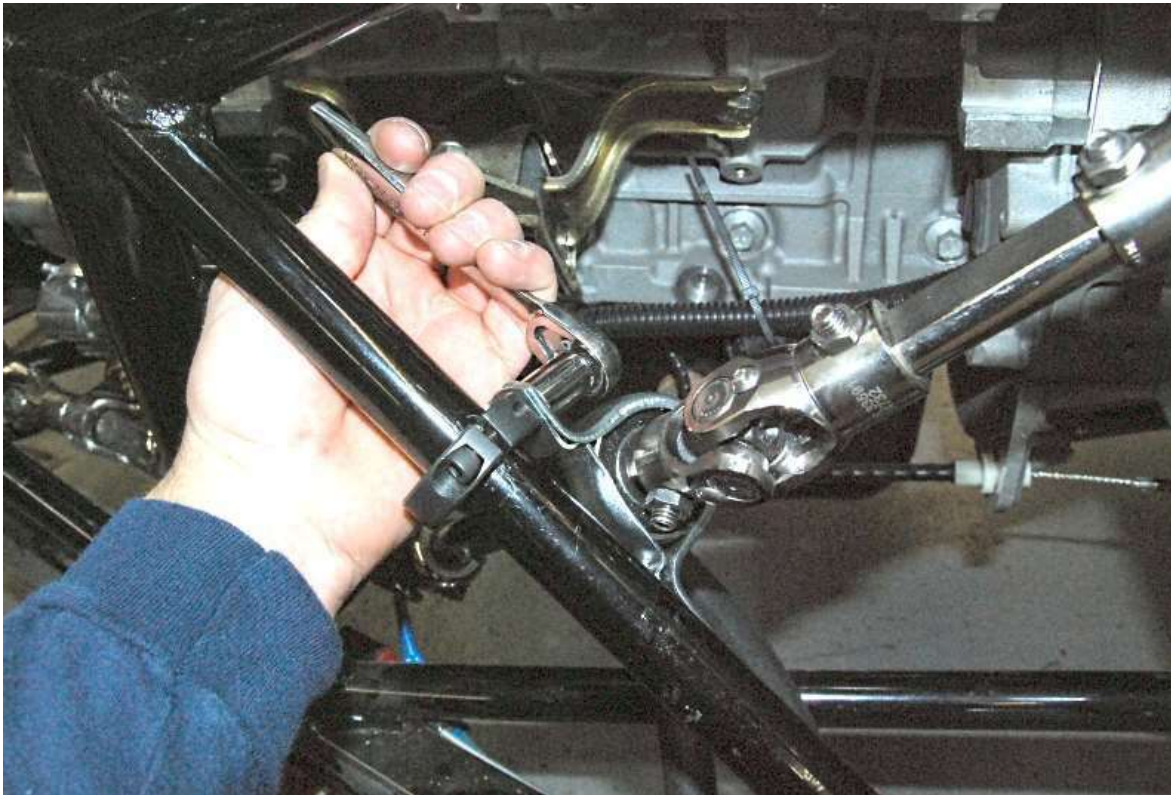

Loosely attach the pillow block to the tube clamps, the screws will not tighten because of the tube.





Locate the tube clamps on the tube so that the shaft is as straight as possible and then tighten the clamps.

Remove the pillow block screws and use a marker or small drill bit through the screw hole to mark the location on the 1" tube.

Remove the tube clamps.

Drill the marked locations using a 1/4" drill bit. This will allow the pillow block mounting screw to go into the tube and also prevent the tube clamps from turning or moving if they loosen for some reason.

Reassemble the tube clamps and pillow block on the tubes using the pillow block mounting screws in the drilled holes to locate them.



Tighten the set screws on the steering joint and pillow block.

## Wiring

- ✂ Soldering iron, solder, electrical tape, wire cutters, wire strippers
- 👉 Use the diagram at the beginning of these instructions for general routing and component location.



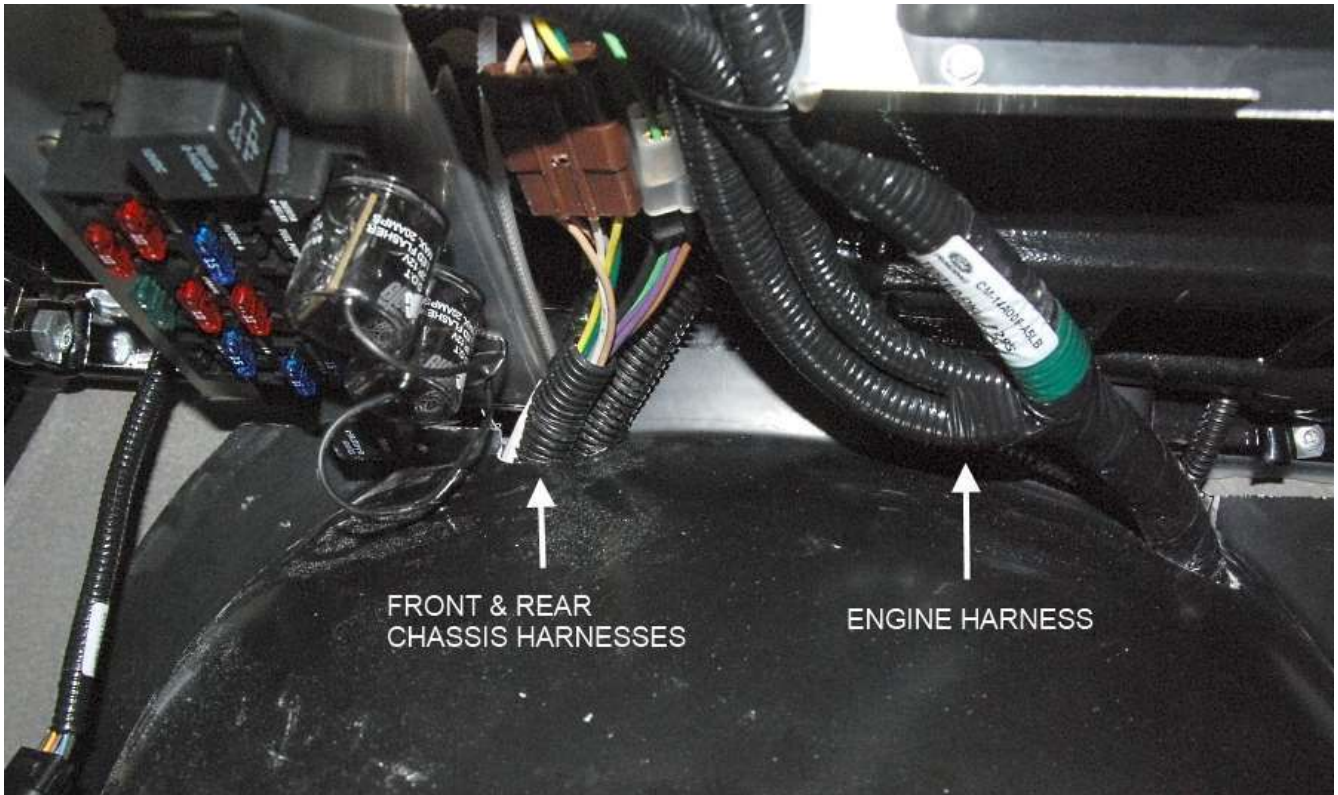

The main wiring harness will exit the cockpit towards the right side of the transmission tunnel.

## Cockpit

### 16-WAY PIGTAIL

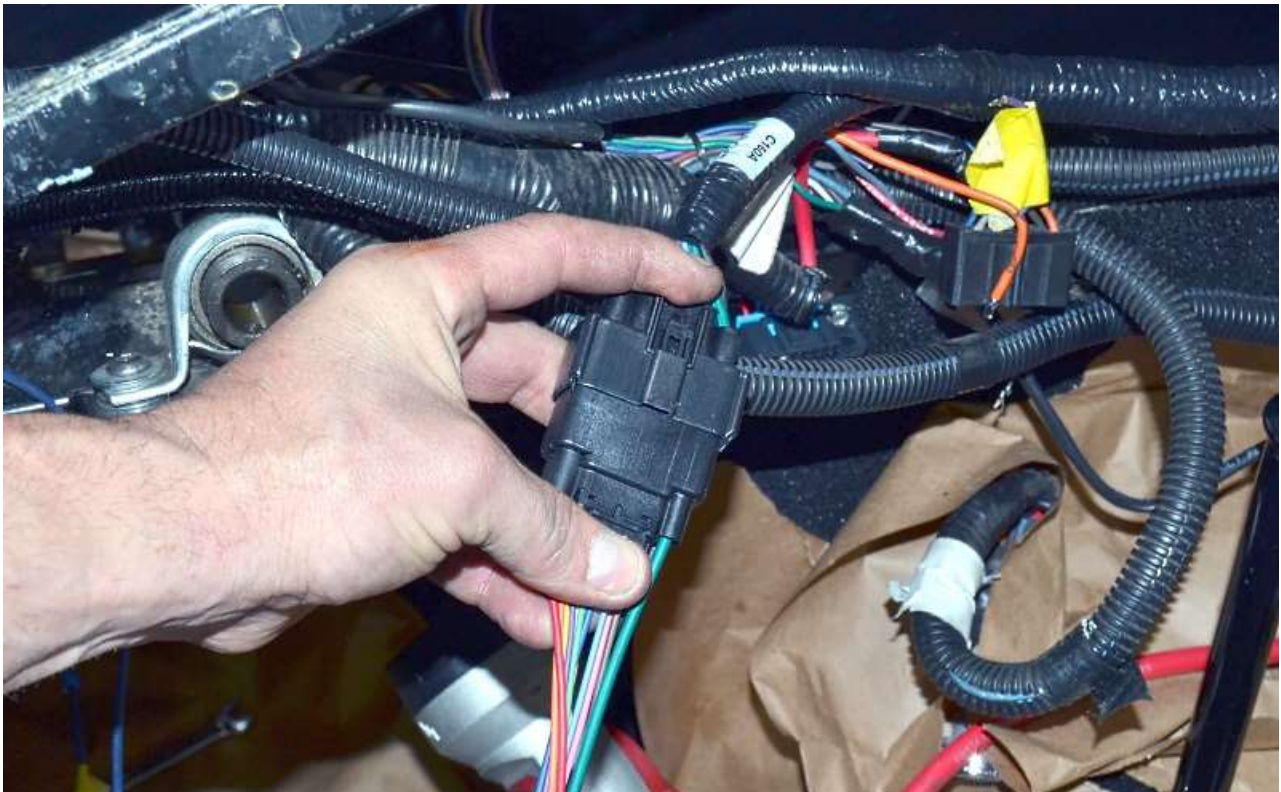

Connect the 16 way pigtail plug to the harness.

## Engine bay

### COMPUTER



Locate the computer so that the engine plugs will reach and the wires going inside will reach up through the transmission tunnel area.

Connect the Engine harness plug and the Control pack plugs to the computer.





Connect the Engine harness plug to the control pack plug.

Run the BB harness across the back of the engine to the left side.



Run the BB harness leg back to the front of the engine on the left side.

## MASS AIR METER



Plug the mass air meter connector into the mass air meter.

## Fuel Pump

Route the Coyote harness fuel pump green wire to the back of the chassis harness fuse panel.



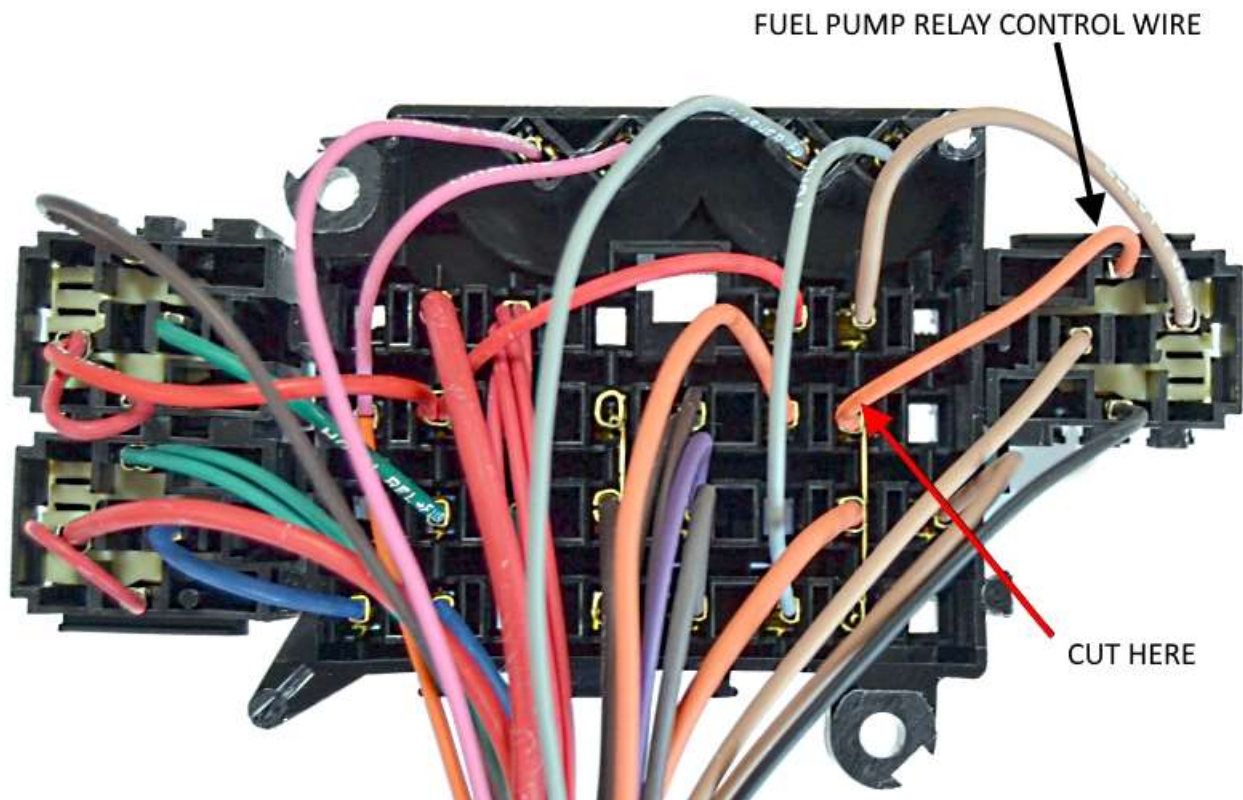

On the chassis harness, cut the small ORANGE jumper wire close to the buss bar that it jumpers from and connect the fuel pump wire from the EFI harness to the orange relay wire. This will use the EFI computer to turn the relay on/off.



The Inertia switch grounds the relay so this wiring still uses the inertia switch.



Solder and tape the green wire and Fuel pump relay wires together.

Make sure the wires and harness are out of the way of the steering shaft.

## Clutch position switch

-  Ford Performance bottom travel switch, coyote clutch switch components.
-   $\frac{1}{2}$ " ,  $\frac{9}{16}$ " wrench,  $\frac{1}{2}$ " socket, Ratchet,  $\frac{3}{16}$ " ,  $\frac{5}{16}$ " hex keys.
-  The install is shown outside the footbox for better pictures.

Remove the clutch cable from the quadrant.



On the clutch pedal, remove the last  $\frac{1}{8}$ " clutch quadrant end plate and replace it with the stainless bottom switch clutch quadrant plate.





Tighten the locknuts.

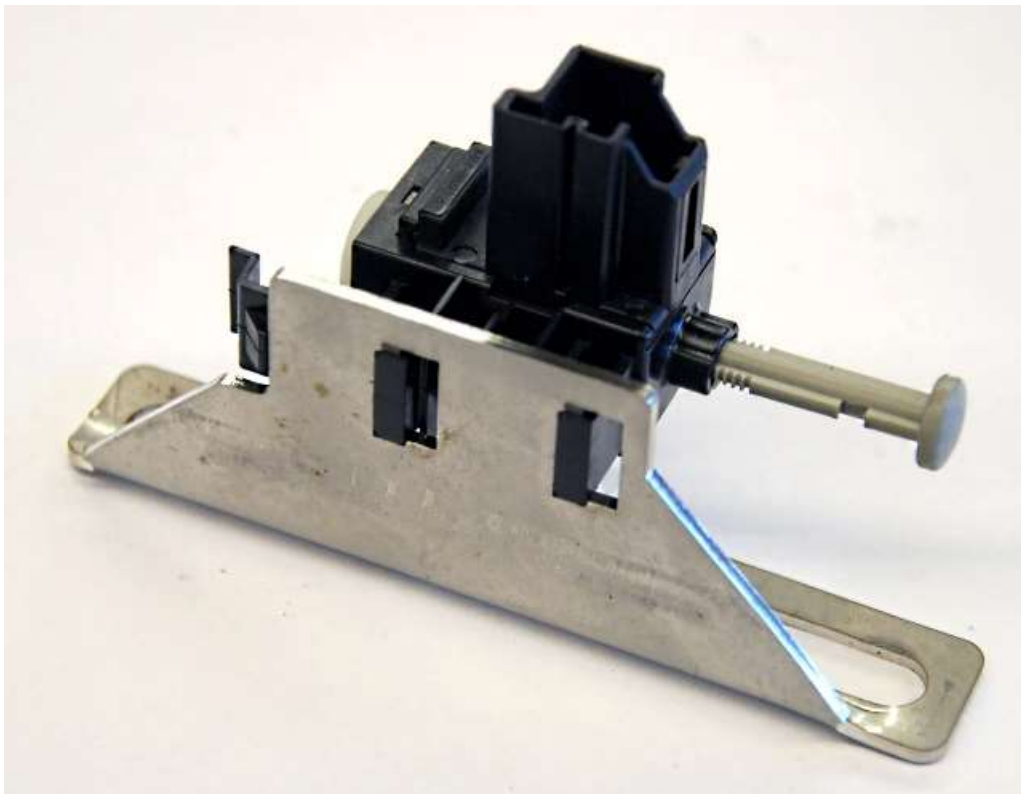

Attach the Bottom travel (gray plunger) clutch switch to the bottom travel switch mount as shown.

Remove the bolts holding the left side of the pedal box to the mount bracket.



Insert the new  $\frac{5}{16}$ " x 1.25" bolts through the bottom travel switch mount then through the pedal box bracket and pedal box.



Attach the top travel clutch switch bracket to the bottom of the bolts.





Snug the bolts up with a 1/2" wrench and socket so the bottom travel switch bracket can still move.

Reattach the clutch cable to the quadrant.

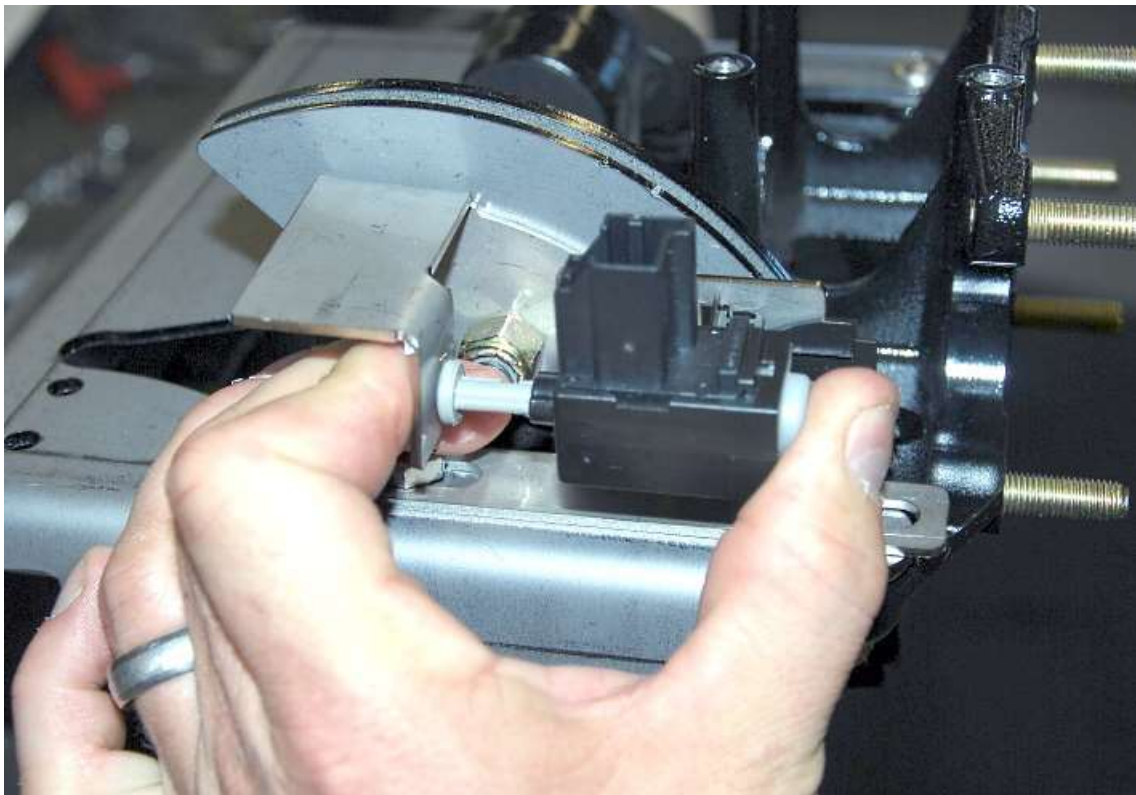

Have someone push the clutch pedal all the way in then slide the bottom travel switch mount so that the bottom travel switch is pressed in all the way against the quadrant plate. Hold the switch mount so that it

does not move and let the clutch out then tighten the pedalbox mount screws with a ½” wrench and socket making sure the switch mount does not move.

Check the throw of the clutch pedal again carefully. The switch should get pressed in all the way but should not get pushed hard enough to stress/move the body of the switch.

## Radiator Cooling Fan

👉 It is best to let the engine control the radiator fan. If you do not want to do this, do not use the wires and remove the correct radiator fan fuse from the black box.



Pull the blue fan wire out of the chasis harness back to the steering bearing mount.





Cut the blue fan wire.

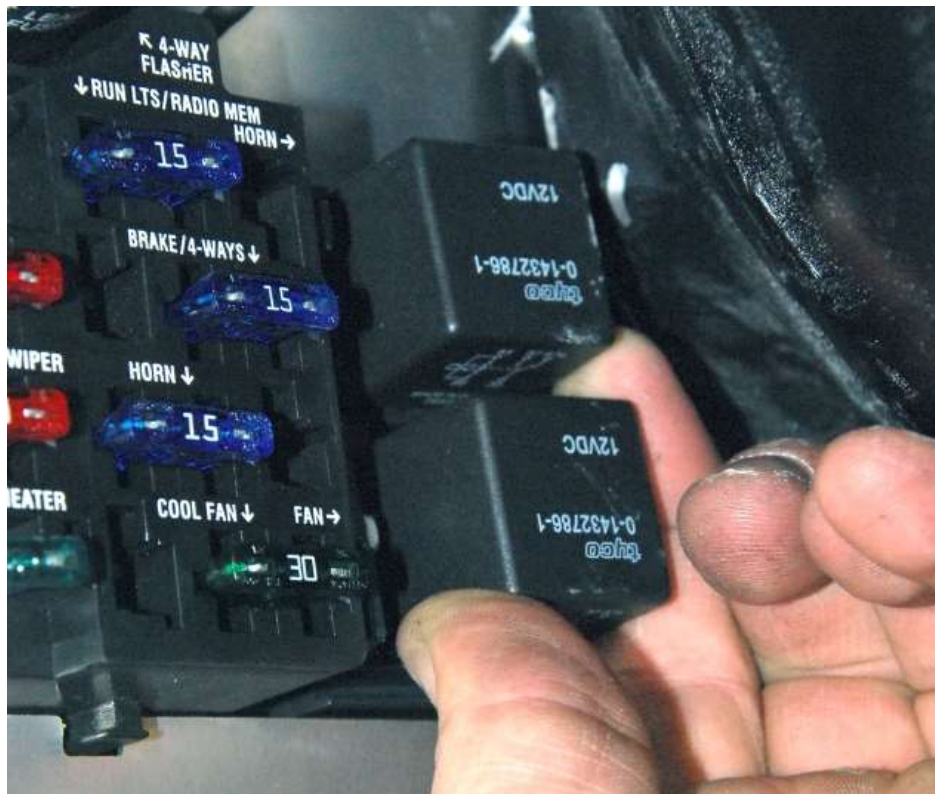

Remove the fan relay from the fuse panel.

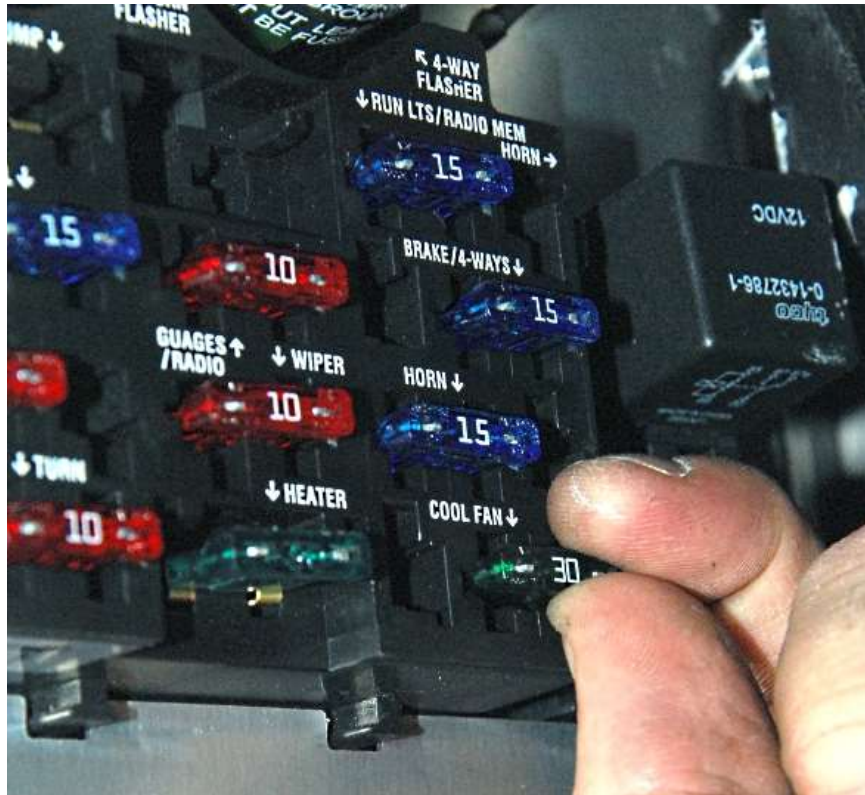

Remove the fan fuse.

Run the orange and black Coyote harness fan wires over to the front chassis harness.

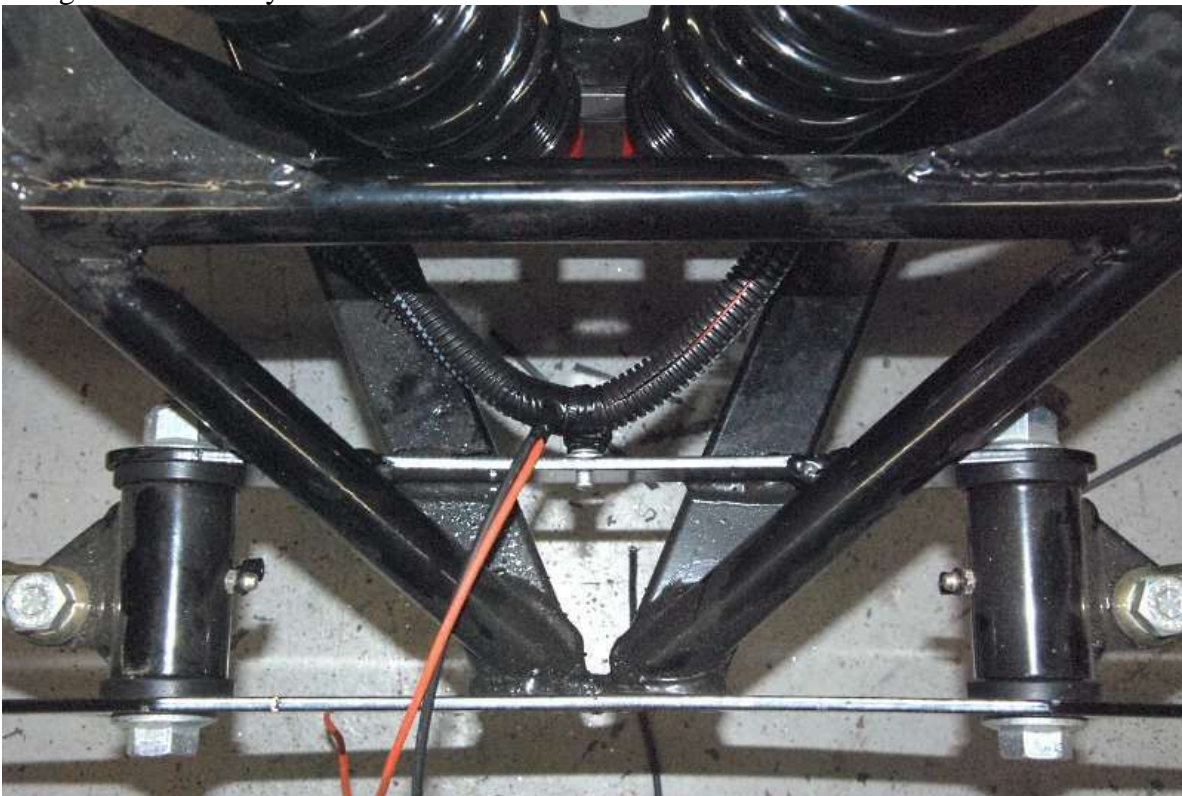

Run the fan wires forward to the front of the frame with the chassis harness.

## Power/start

✂ Soldering iron, wire cutters/strippers, electrical tape





Locate the EFI/crank and coil wires in the chassis harness.



Attach a ring connector to the black ground wire and ground it to the chassis.

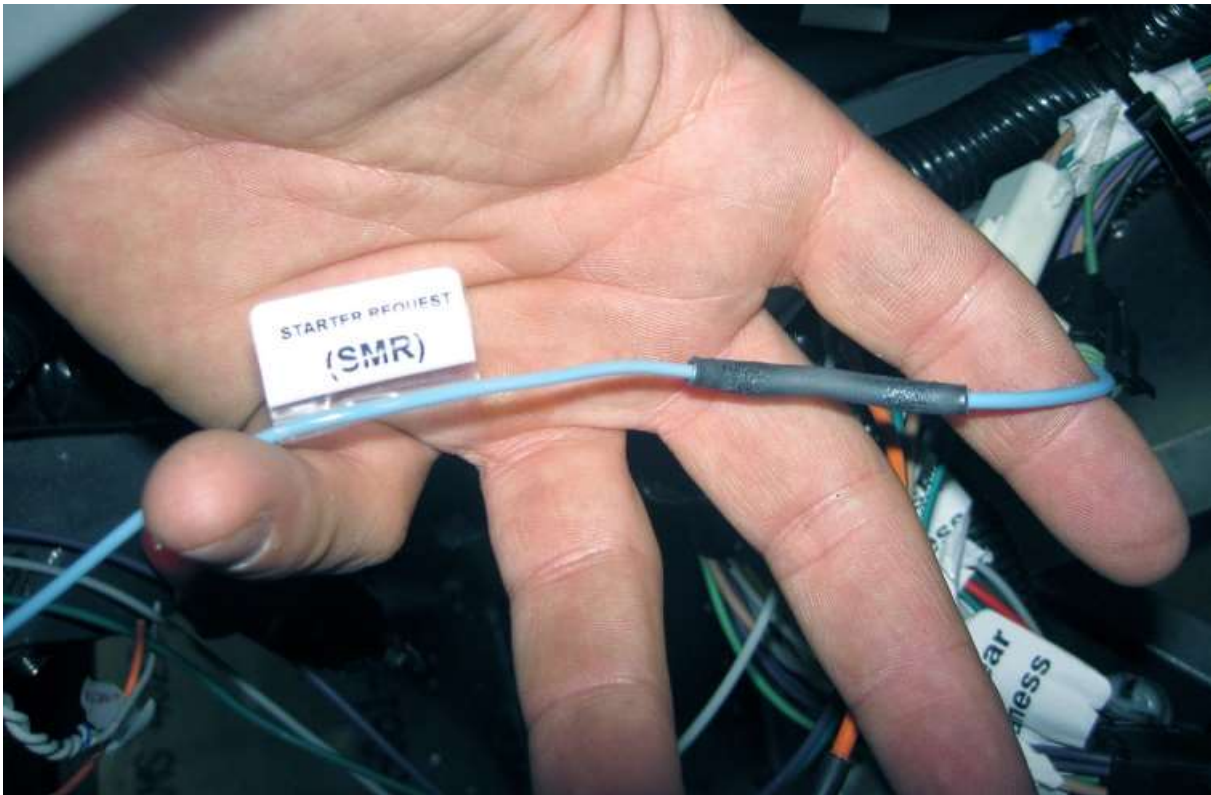

Attach the blue starter wire to the blue EFI wire in the harness.

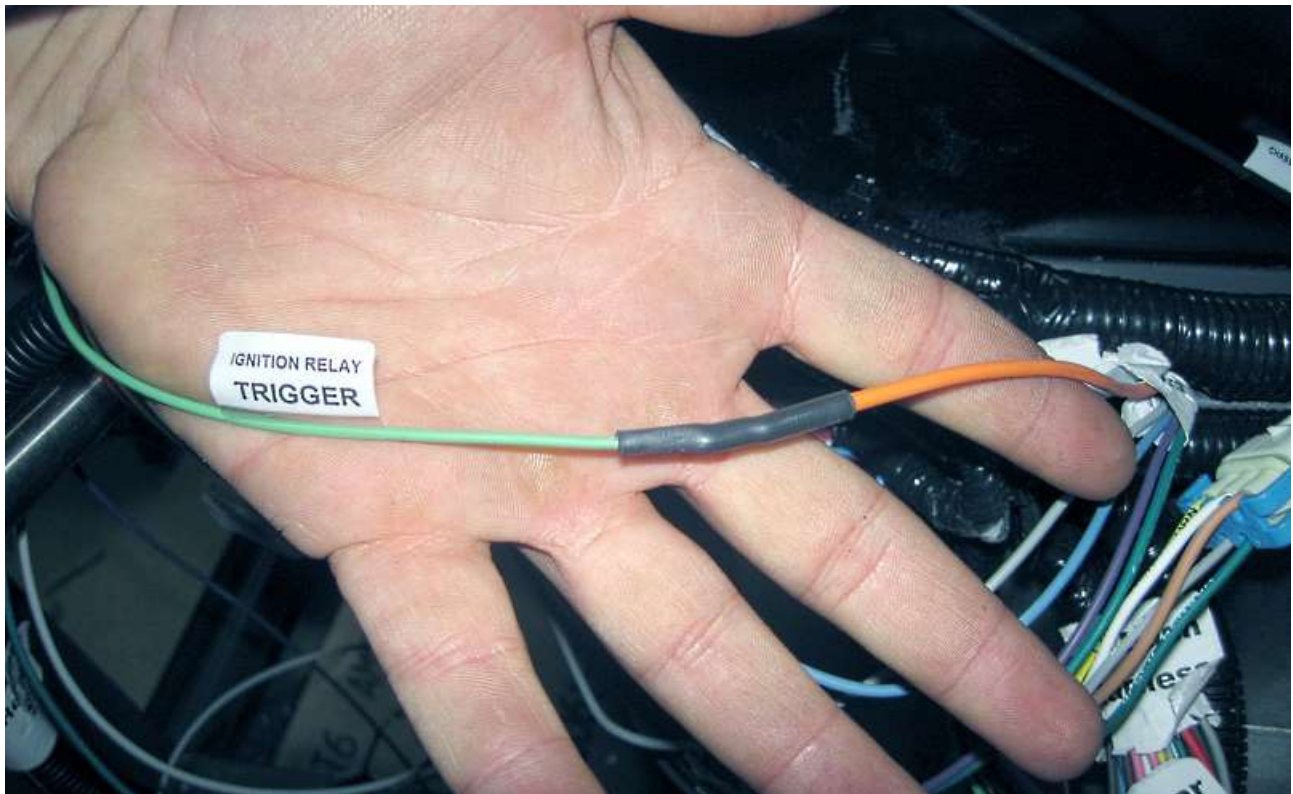

Attach the green ignition trigger wire to the orange EFI wire in the harness.

👉 No other wires are used from the 16 way connector.



☞ We use the PCM engine starting directions in the Ford Performance instructions. This uses the engine harness starting wire to engage the starter.

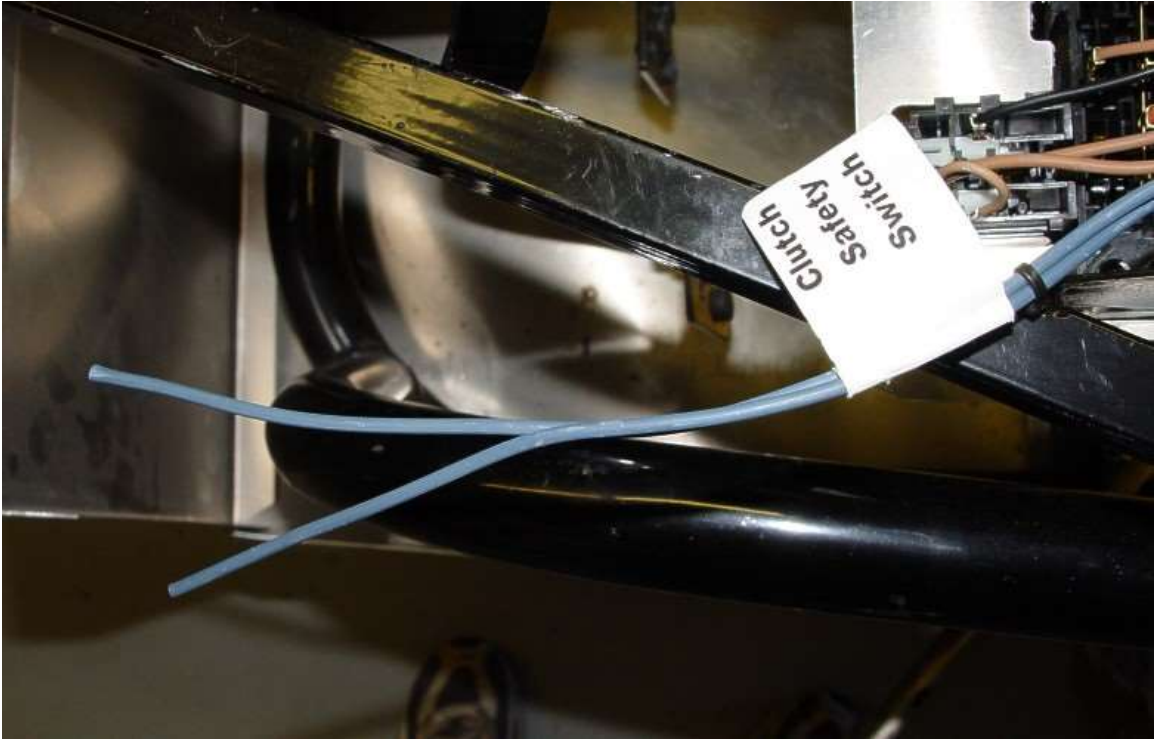

Find the clutch safty switch wires in the left footbox.

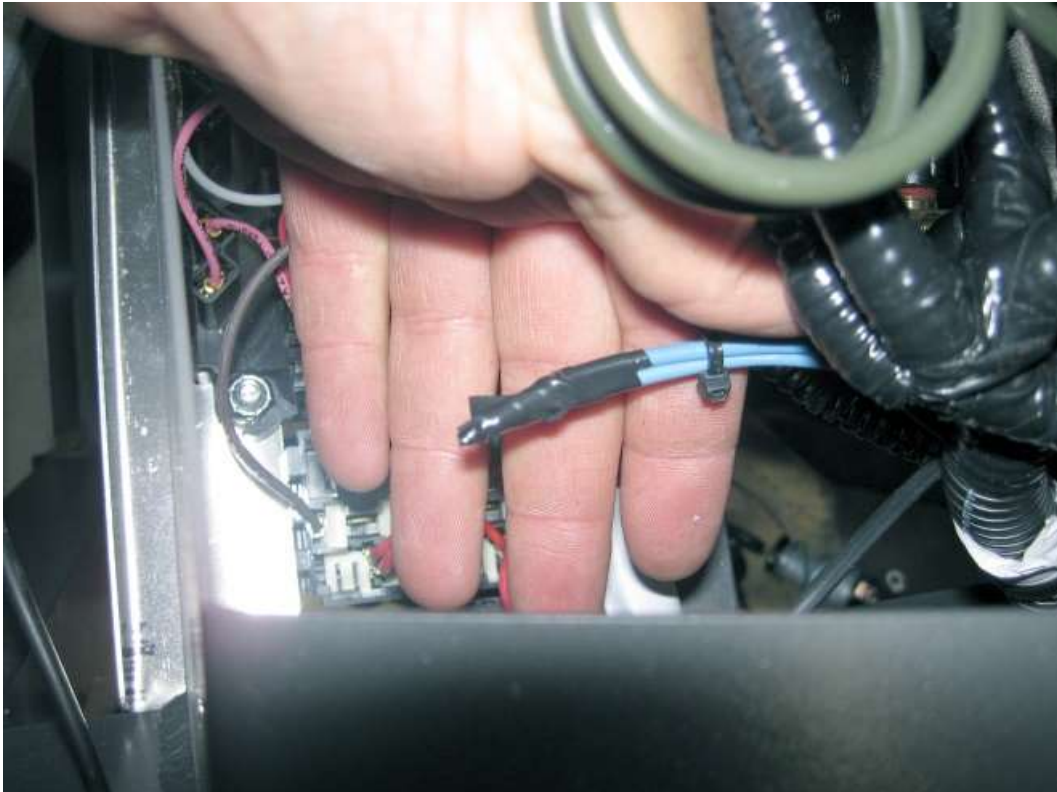

If a neutral safety switch is not going to be used, cut one of the two blue chassis harness wires slightly shorter than the other so the ends do not touch and electrical tape the end .



In the chassis harness on the starter wires leg, cut the blue starter wire end off.



Pull the loom back further down the leg then pull the blue wire out so it does not stick out for the harness and cut it off.





Electrical tape the end to the other wires.

## Tach



Soldering iron, wire cutters/strippers, electrical tape.



There is no tach wire in the engine harness. The tach will need to get connected to a coil wire as shown in the gauge instructions according to the Type #3 Coil on plug description.



Run the sending unit harness along the lefttop side of the engine.



At the #4 cylinder, pull the chassis harness tach wire (purple) out of the harness and remove the tape covering the coil plug wires.



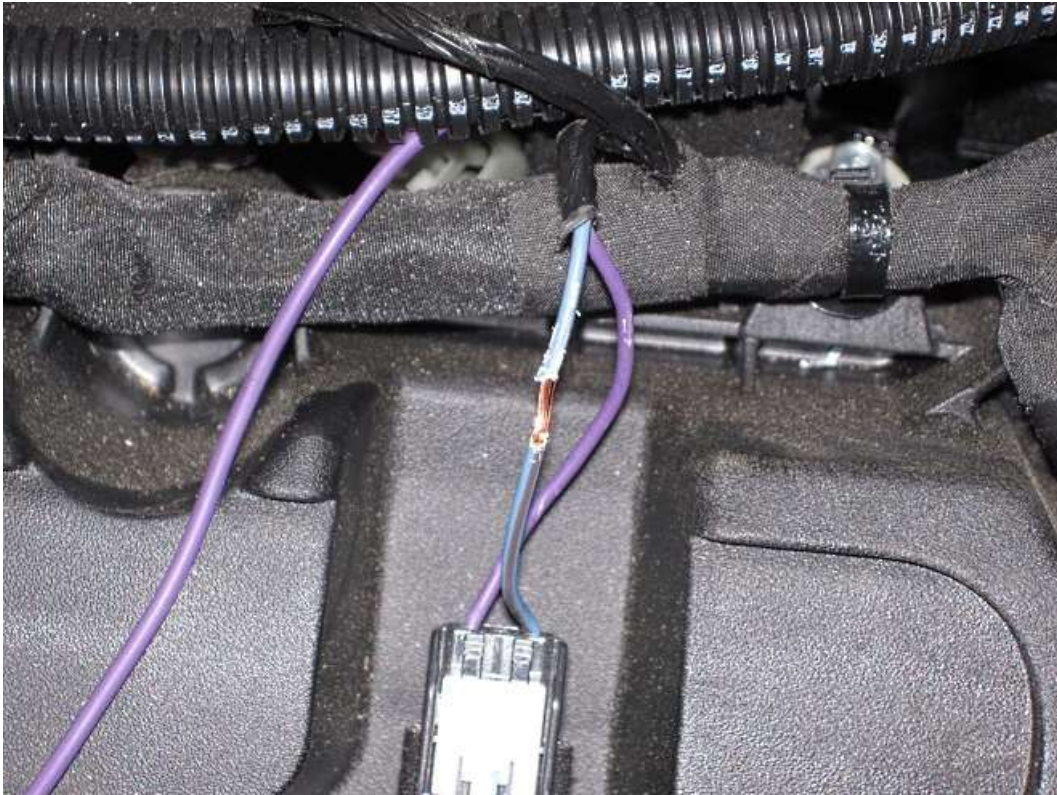

Use a razor knife and wire strippers to remove a short section of the wire insulation on the blue/red wire.

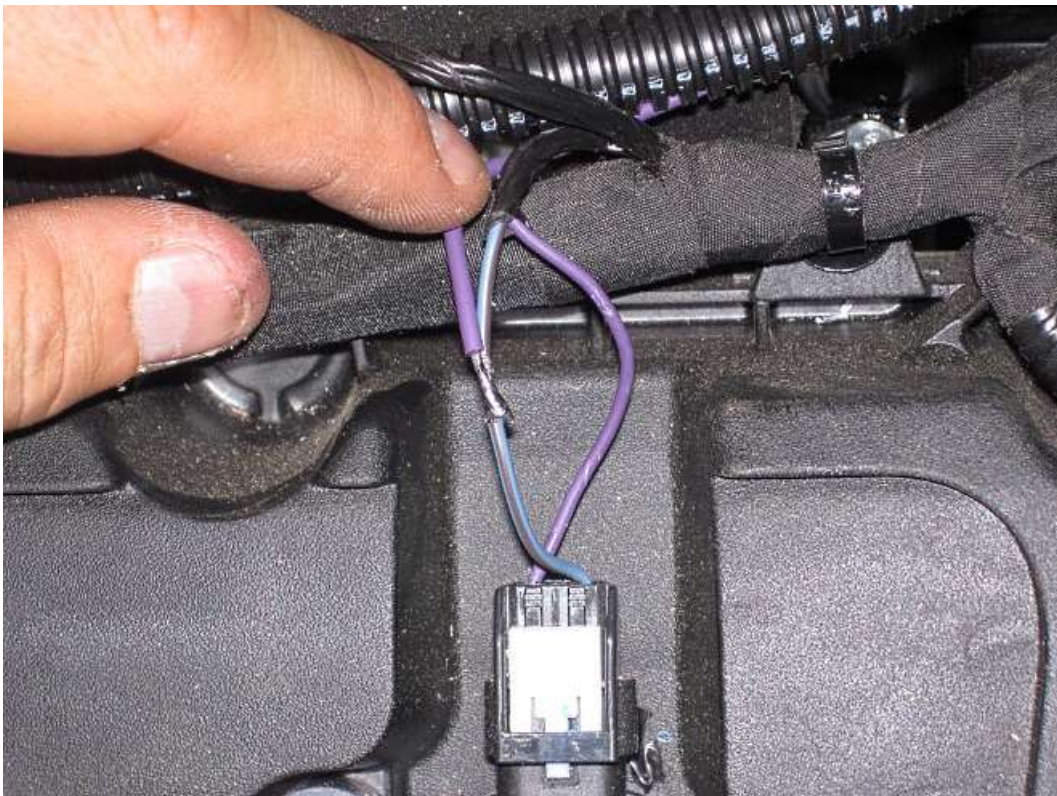

Solder the tach wire to the blue/red wire.





Wrap the connection in electrical tape.



Re-wrap the coil plug wires.



## Oil Pressure and Water temp sensors



Continue the sending unit harness to the front of the engine.



Use some of the kit  $\frac{3}{4}$ " loom to cover a couple of the smaller looms to declutter the wiring.

Run the wires down the front of the engine to the sending units.





Attach the gauge sensor wires to the correct sensor.

## OBD 2 Port



Locate the OBD 2 port on the 2"x 2" tube to the right of the steering wheel.



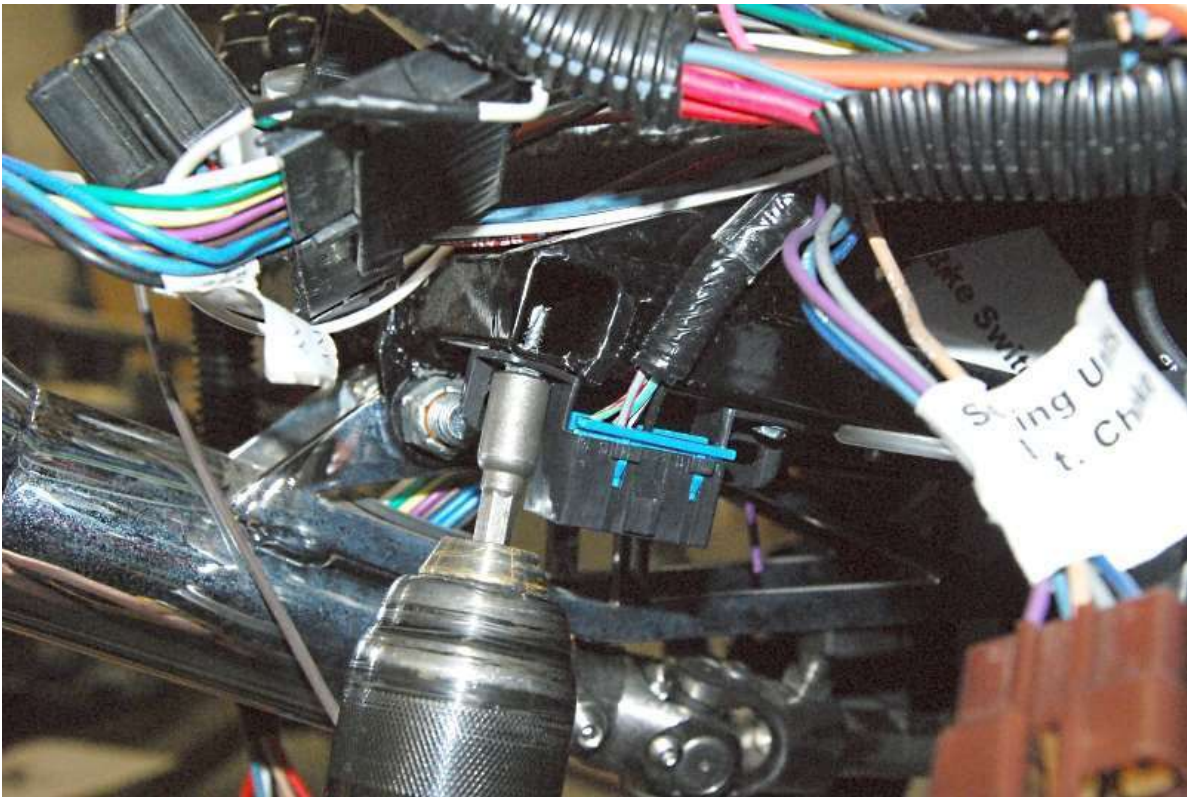

Use some of the aluminum panel #6 screws to attach the OBD 2 plug to the frame.

## Clutch cable



Attach the clutch cable to the quadrant and to the clutch fork.



## Starter Solenoid



The solenoid on the starter is the one being used to start the engine.

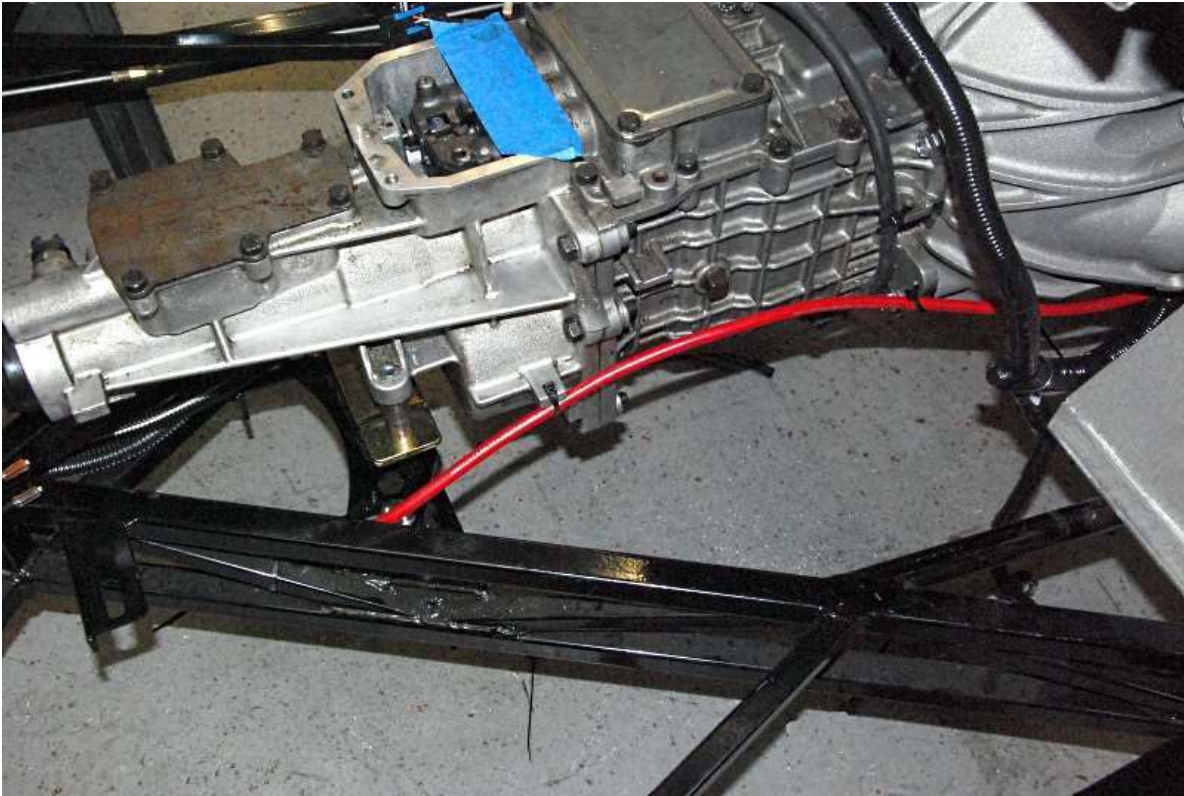

Run the battery cable forward along the transmission from the battery.

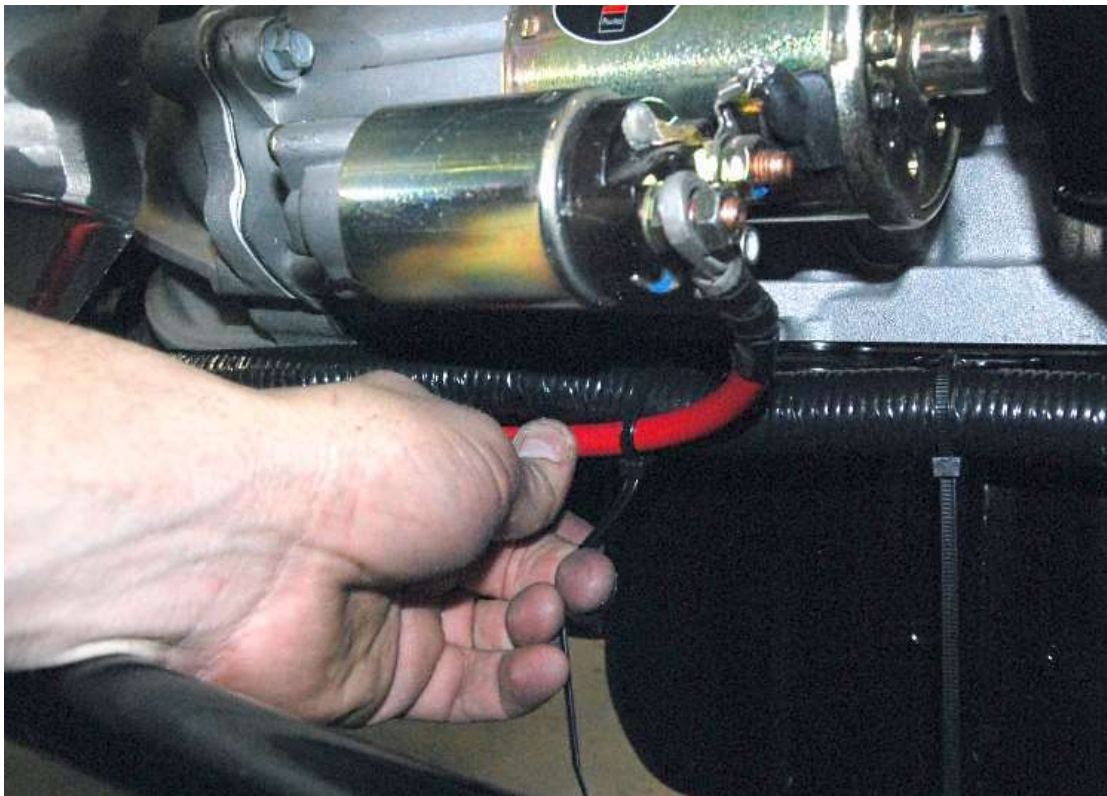

Attach the battery cable to the starter solenoid.



- ✎ Make sure not to push the cable too far over or it may contact the starter post.
- ✂  $\frac{5}{32}$ " hex key,  $\frac{1}{2}$ " wrench,  $\frac{1}{4}$ " drill bit, 1" hole saw, drill
- 🔧  $\frac{1}{4}$ "-20 stainless washer head screws, locknuts, expandable grommet, Ford Performance control pack in-line fuse mount and 4ga battery cable.



Locate and mark the inline fuse just to the left of the dash support post on the firewall or on the 2" tube.

If firewall mounting, drill  $\frac{1}{4}$ " holes and use the  $\frac{1}{4}$ "x 0.75" stainless washer head screws, locknuts along with a  $\frac{5}{32}$ " hex key and  $\frac{1}{2}$ " wrench to attach the fuse mount to the firewall.

If mounting the fuse mount to the tube, use the #8 x  $\frac{3}{4}$ " self-tapping screws.

Wire the fuse and harness per the Ford performance "Power distribution Box Installation Instructions".

Drill a 1" hole at the top center of the transmission tunnel then insert the expandable grommet.

Run the positive battery cable connecting to the fuse out of this hole and to the battery side of the starter solenoid on the starter.



Ground the control pack harness to the frame, make sure to remove any frame coating to ensure a good ground.

## **O<sub>2</sub> Harness**

✂ Soldering iron, wire cutters/strippers, electrical tape





Attach the right O<sub>2</sub> sensor to the connector at the back of the head.



Connect the left O<sub>2</sub> sensor to the connector down near the engine mount

## Intercooler wire



Cut the white/red Intercooler pump wire as far back in the harness as you can. It is not needed or used.

## Power Distribution

- ✂ Wire cutters/strippers, electrical tape, wire crimpers.
- ✎ We used an extra starter solenoid for power distribution in these instructions. A distribution post is provided in the Coyote kit.
- ✎ The solenoid on the starter is the one being used to start the engine.

Locate and attach the power distribution post to the 2"x 2" tube.

Shorten and attach the red wire from the black box to the power distribution post using one of the yellow ring connectors.

Attach a ring connector to the 10 ga red wire.

Attach the 10 ga wire ring connector to the post.

Run the 10 ga wire to the battery side of the starter solenoid on the engine.

Cut the wire to length and attach another yellow ring connector.

## Gauges

### TACH

- ✂ Soldering iron, wire cutters/strippers, electrical tape

There is no tach wire in the engine harness. The tach will need to get connected to a coil wire as shown in the gauge instructions according to the #3 Coil on plug description.



## WATER TEMP SENDER

✂ Wire cutter, wire crimper,  $\frac{3}{8}$ " wrench



Run the blue water temp chassis harness wire to the sending unit and cut to length.

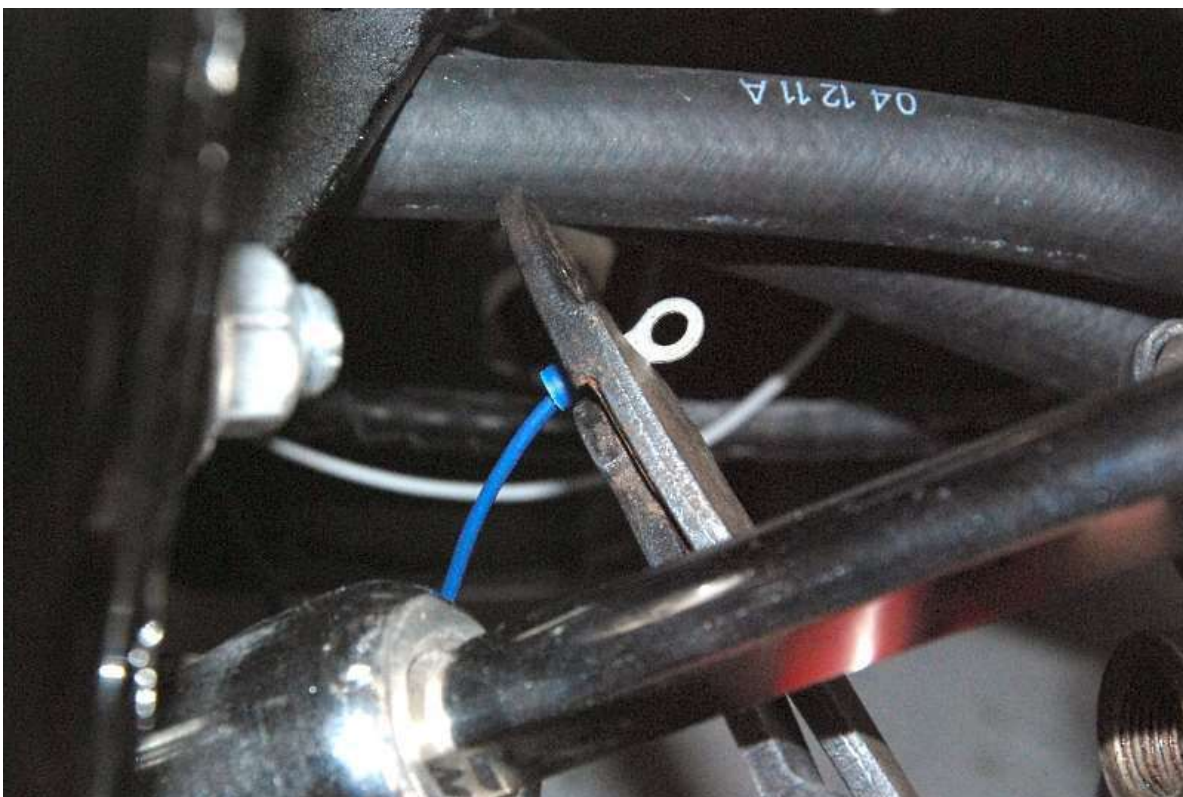

Crimp a ring terminal to the sending unit wire.



Attach the ring terminal to the water temp sending unit.

### **OIL TEMP SENDER**

✂  $\frac{3}{8}$ " ,  $\frac{11}{16}$ " wrenches, Wire cutter, wire crimper



Push the Engine/computer harness plug onto the stock sending unit.



Run the chassis harness gray oil pressure wire to sending unit and cut to length. Crimp on a blue ring terminal connector.







Rotate the sending unit so the computer sending unit is facing the rear of the engine.



Attach the sending unit wire ring terminal to the sending unit.

# Alternator

-  10mm, 13mm, (2) 17mm wrenches, 10mm socket, ratchet, wire stripper, wire crimper
-  Alternator, Alternator drive kit
-  The stock Alternator is designed to run counter clockwise and the frame goes through the stock location so it can not be used. With the internal fan curve direction of the stock Alternator, there is a possibility that the Alternator could overheat when run in the opposite direction.
-  The Honda alternator runs clockwise and when run in the orientation we use it is run the correct way.

ITEM NO.	PART NUMBER	DESCRIPTION	QTY.
1	33824	ALTERNATOR MOUNT BRACKET	1
2	HONDA ALTERNATOR		1
3	33825	1.18" SPACER	1
4	33827	1.00" SPACER	2
5	33825	3.37" SPACER	1
6	33826	3.48" SPACER	1
7	hex cap screw_cm	M10-1.5mm x 110mm HEX HEAD CAP SCREW	1
8	B18.23.1M - Hex cap screw, M10 x 1.5 x 65 --263		1
9	M10F	NUT NYLOC M10 TYPE F	1
10	hex cap screw_cm	M8-1.25mm x 140mm HEX HEAD CAP SCREW	2
11	B16.23.1M - Hex cap screw, M8 x 1.25 x 80 --22N		1

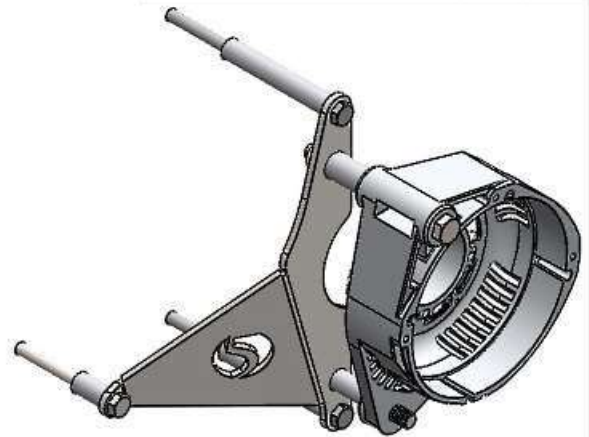
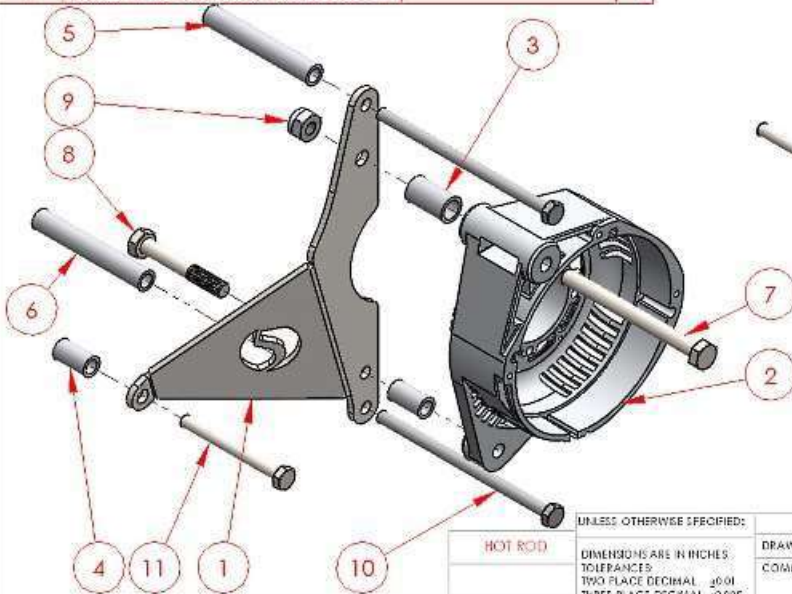

REV.	DESCRIPTION	DATE	APPROVED
A	INITIAL RELEASE	1/20/15	

UNLESS OTHERWISE SPECIFIED:		NAME	DATE	 <b>Factory Five Racing, Inc.</b>
DIMENSIONS ARE IN INCHES TOLERANCES TWO PLACE DECIMAL .001 THREE PLACE DECIMAL .0005 FOUR PLACE DECIMAL .0001		JI	2/5/15	
MATERIAL		COMMENTS		TITLE:
FINISH		APPLICATION:		<b>HOT ROD COYOTE ALTERNATOR DRIVE</b>
USED ON	PRINTED	SCALE: 1:3	WEIGHT:	REV <b>A</b>
APPLICATION:		1/20/2016		SHEET 1 OF 1

**PROPRIETARY AND CONFIDENTIAL**  
THE INFORMATION CONTAINED IN THIS DRAWING IS THE SOLE PROPERTY OF FACTORY FIVE RACING, INC. ANY REPRODUCTION IN PART OR AS A WHOLE WITHOUT THE WRITTEN PERMISSION OF FACTORY FIVE RACING, INC. IS PROHIBITED.



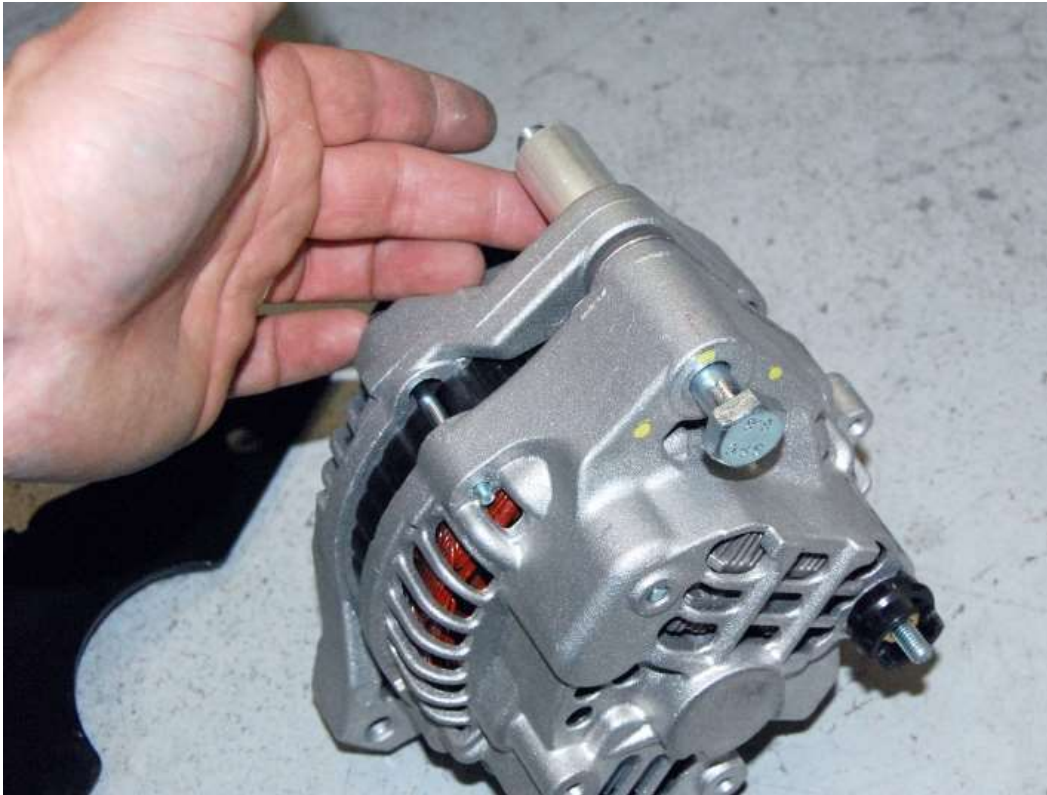

Put the large long bolt through the alternator and place the spacer on the bolt.

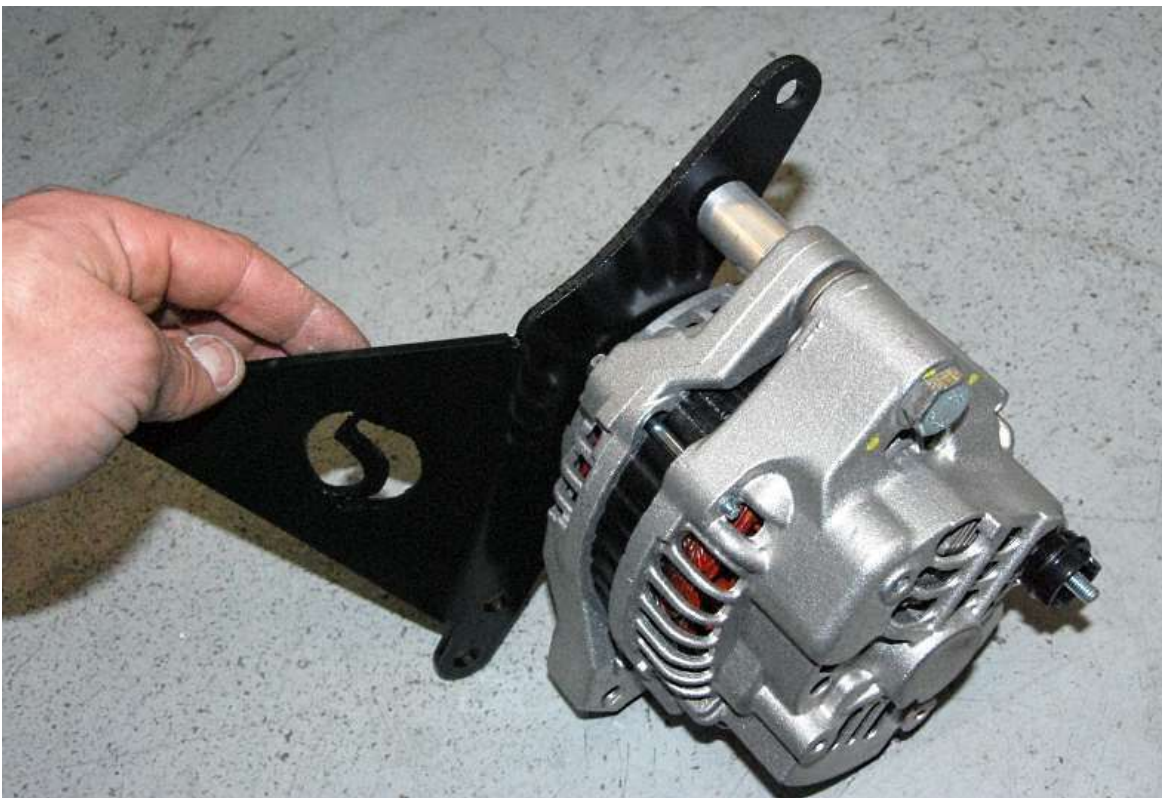

Attach the alternator to the mounting bracket leaving the nut so that the alternator can rotate.

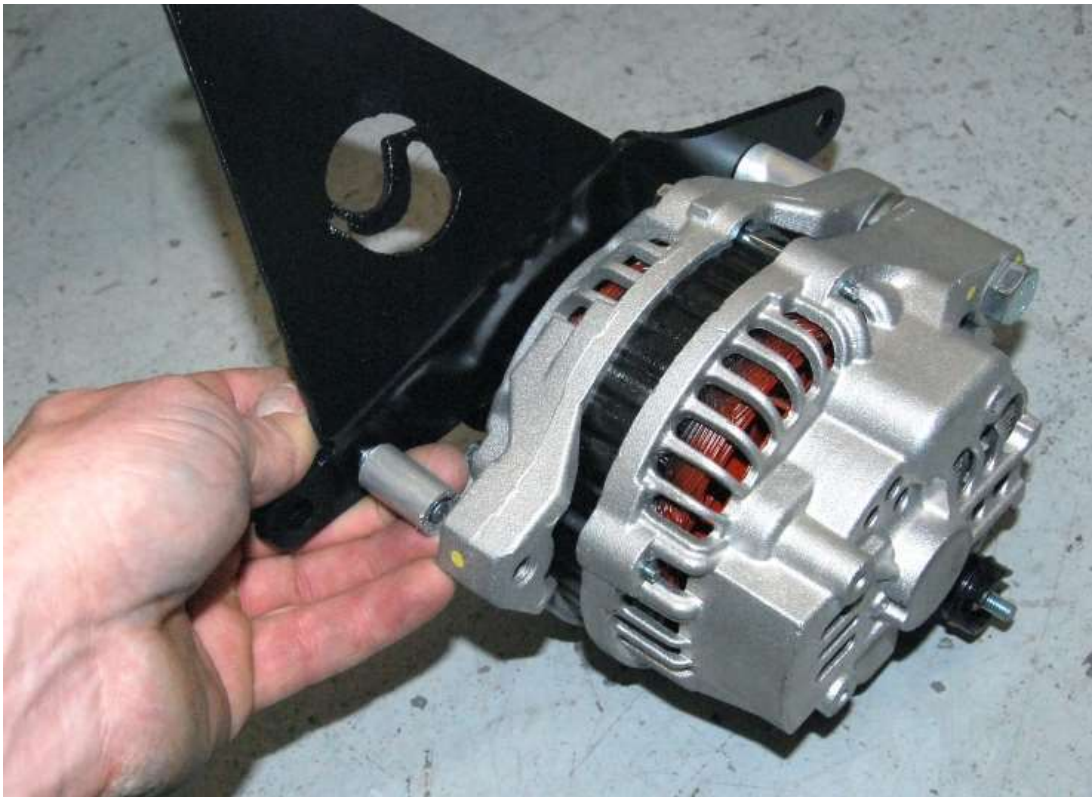

Pass the short bolt through the other bracket mounting hole and place the small ID spacer on the bolt.

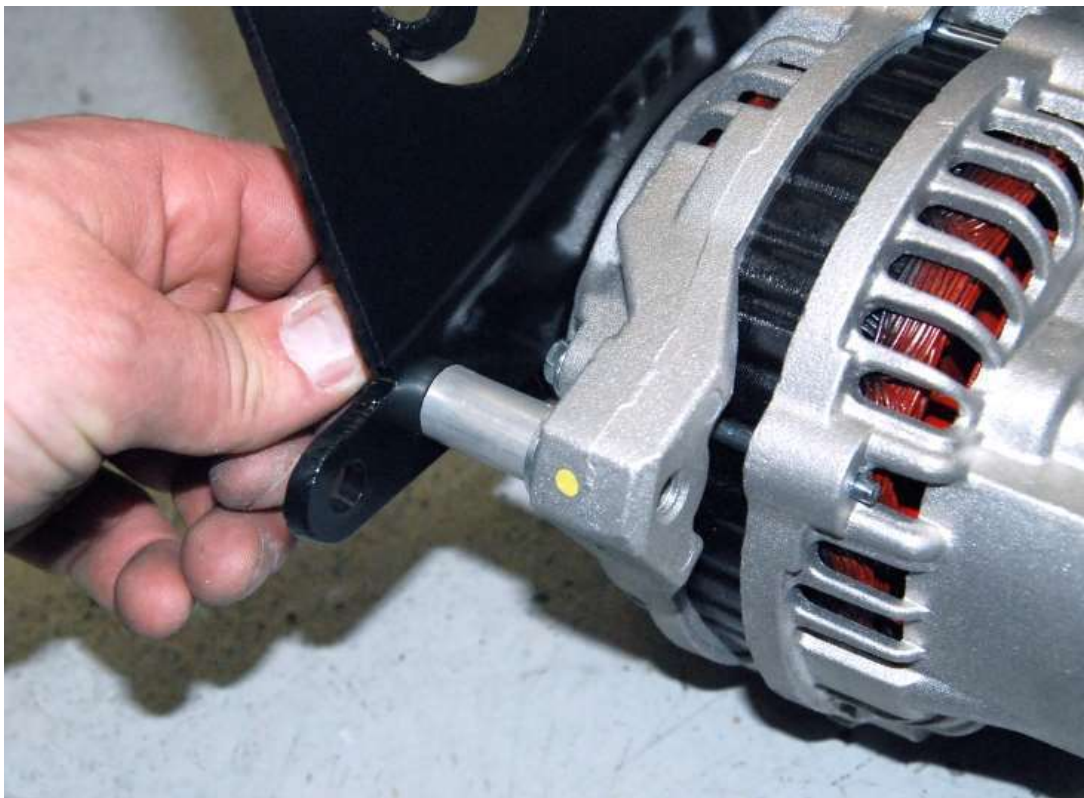

Thread the bolt into the Alternator.



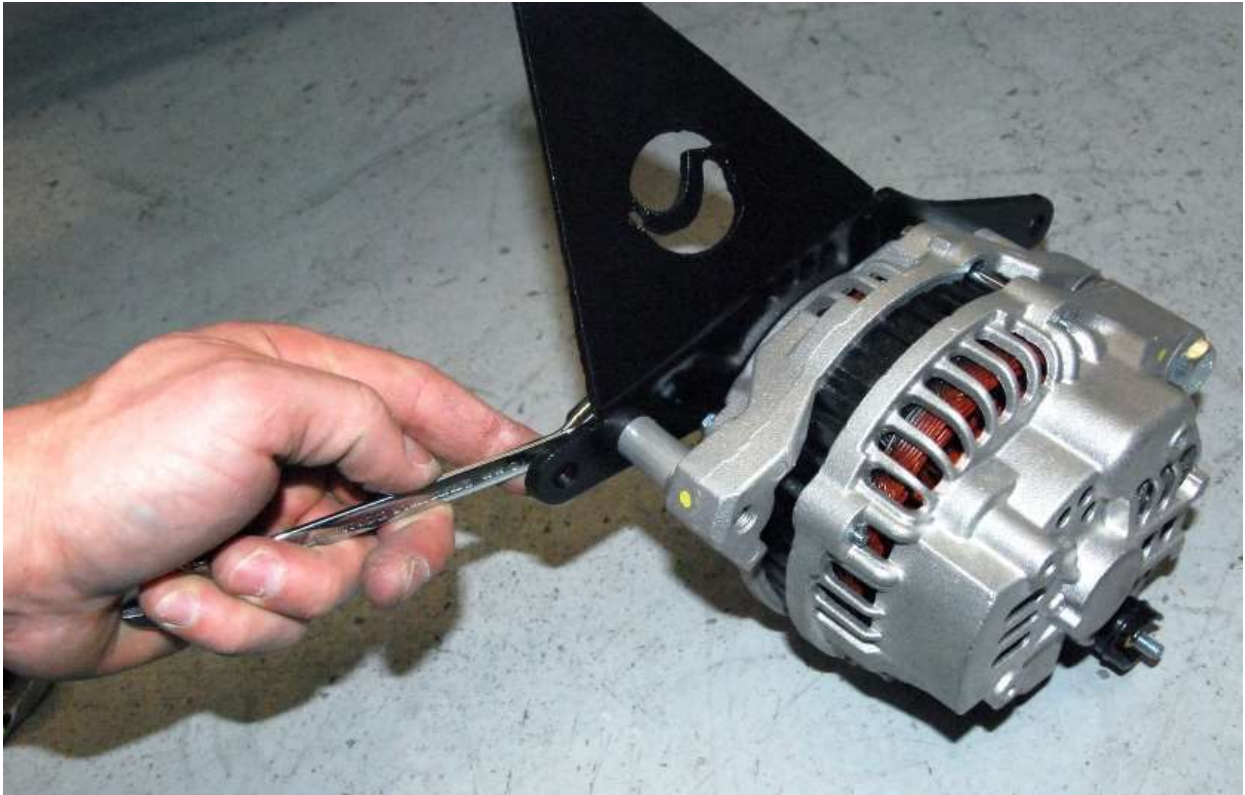

Tighten the alternator mounting bolts.



Run the bracket mounting bolts through the bracket and put the spacers on the bolts.

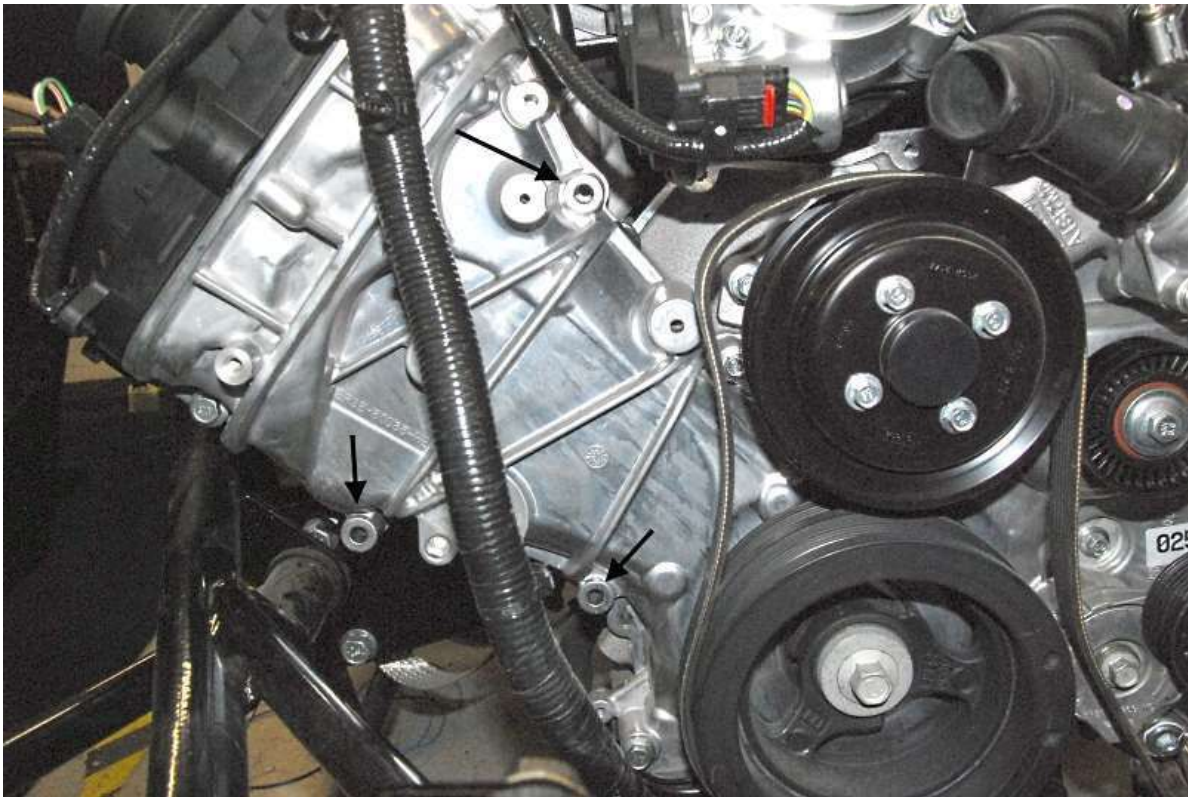

Remove the timing cover screws at the points shown in the picture above.



Attach the mounting bracket to the engine keeping the engine control harness behind the bracket. Belt Tensioner



Ratchet, 15mm socket, vise.



The bolt holding the pulley is left hand thread, do not turn it the wrong way.





Remove the bolt holding the pulley and remove the smooth pulley.



Replace the smooth pulley with the ribbed pulley included. Do not use the metal cover from the smooth pulley.



Attach the belt tensioner to the timing chain cover and tighten to 18 lbft (25Nm) then route the belt as shown.

## WIRING



Run the red chassis harness alternator wire under the firewall up to the right side of the engine.





Run the alternator wire to the front of the engine next to the engine harness.



Run the alternator wire down to the alternator output post.

Cut the wire to length and attach a yellow ring terminal connector.



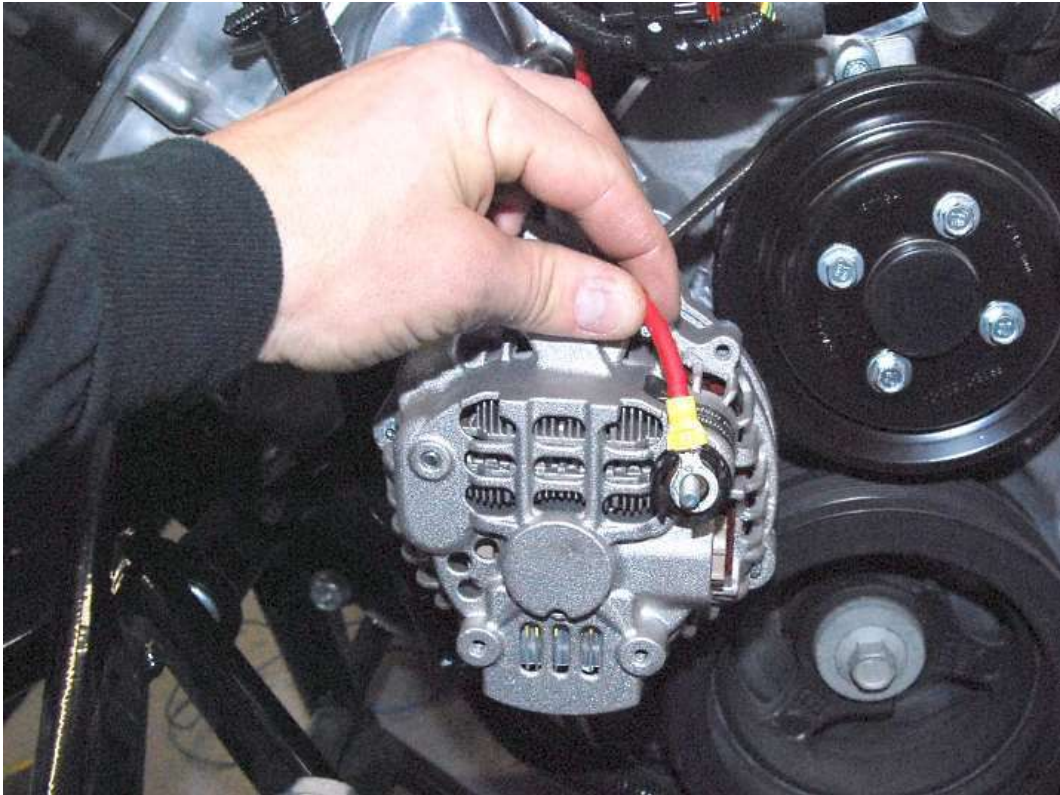

Put the ring terminal on the alternator output post.

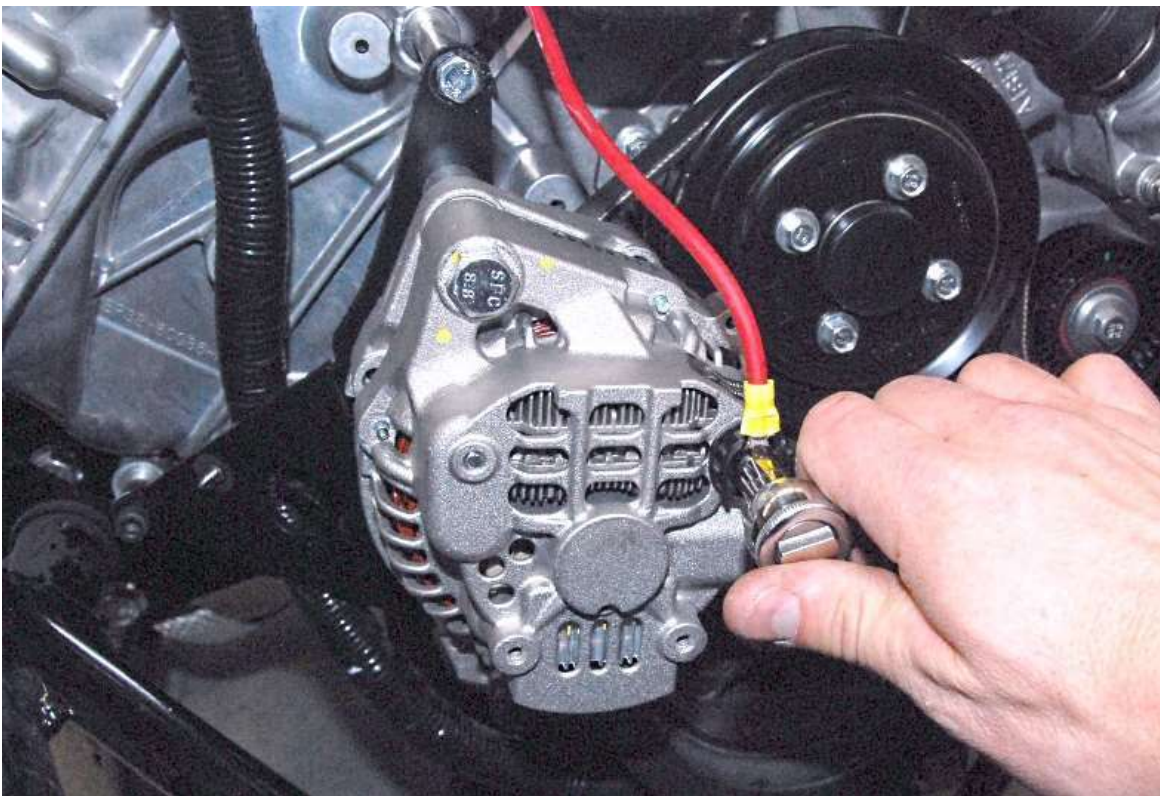

Tighten the locknut on the output post so that the nut is snug. Do not over-tighten or the post might break.



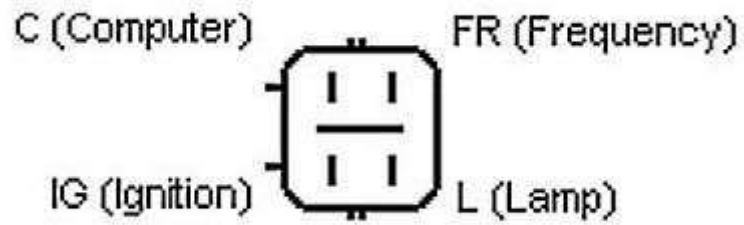

If a dash charge indicator light is desired, run a wire from the “Lamp” connector back to a dash light that is grounded on the other side of the light.

Locate the chassis harness brown alternator wire and run it to the Alternator plug.



Test fit the small connector in the Alternator. If necessary, cut off part of the blue covering so that the connector will fit.



Crimp the small blue connector onto the yellow wire.

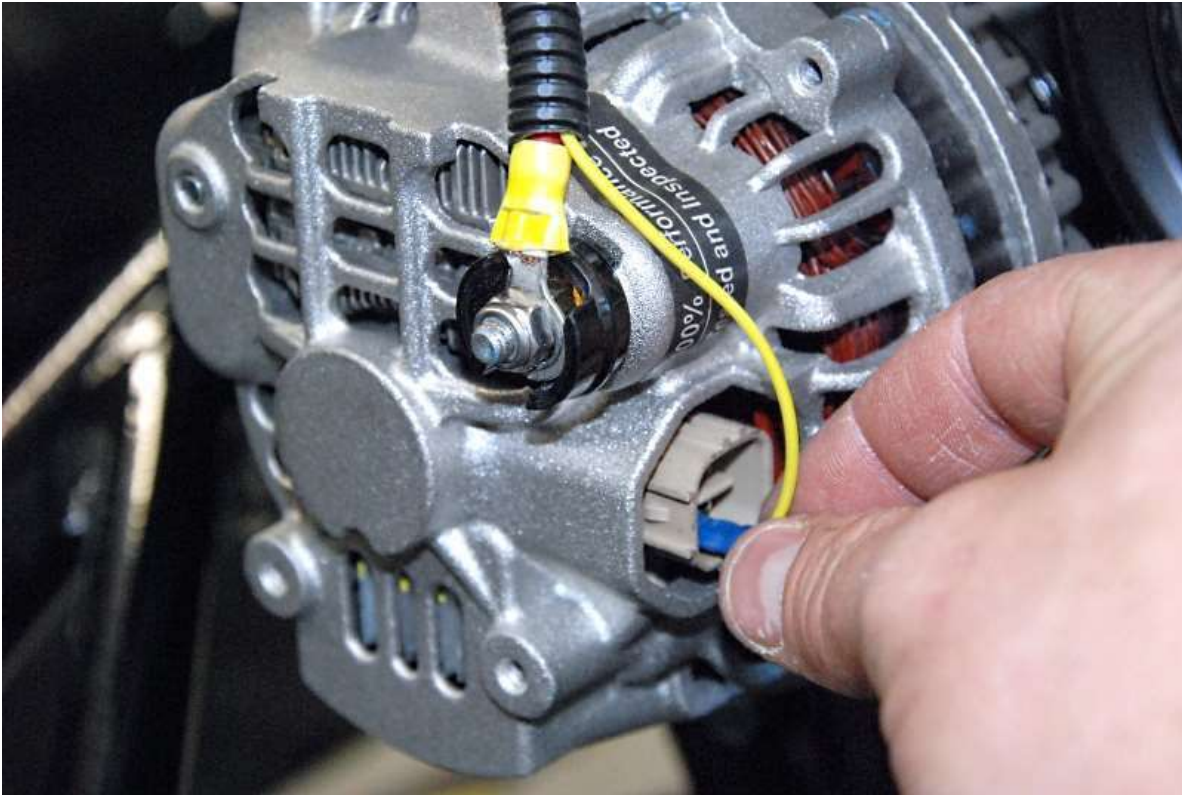

Connect the wire to the “Ignition” connector on the Alternator.

## Accelerator Pedal

- ✂ Hack saw, T-25 Torx bit, ratchet,  $\frac{7}{16}$ ” wrench, silver Marker, Grinder or drill bit, clamp
- 🛠 Accelerator pedal, coyote accelerator install kit



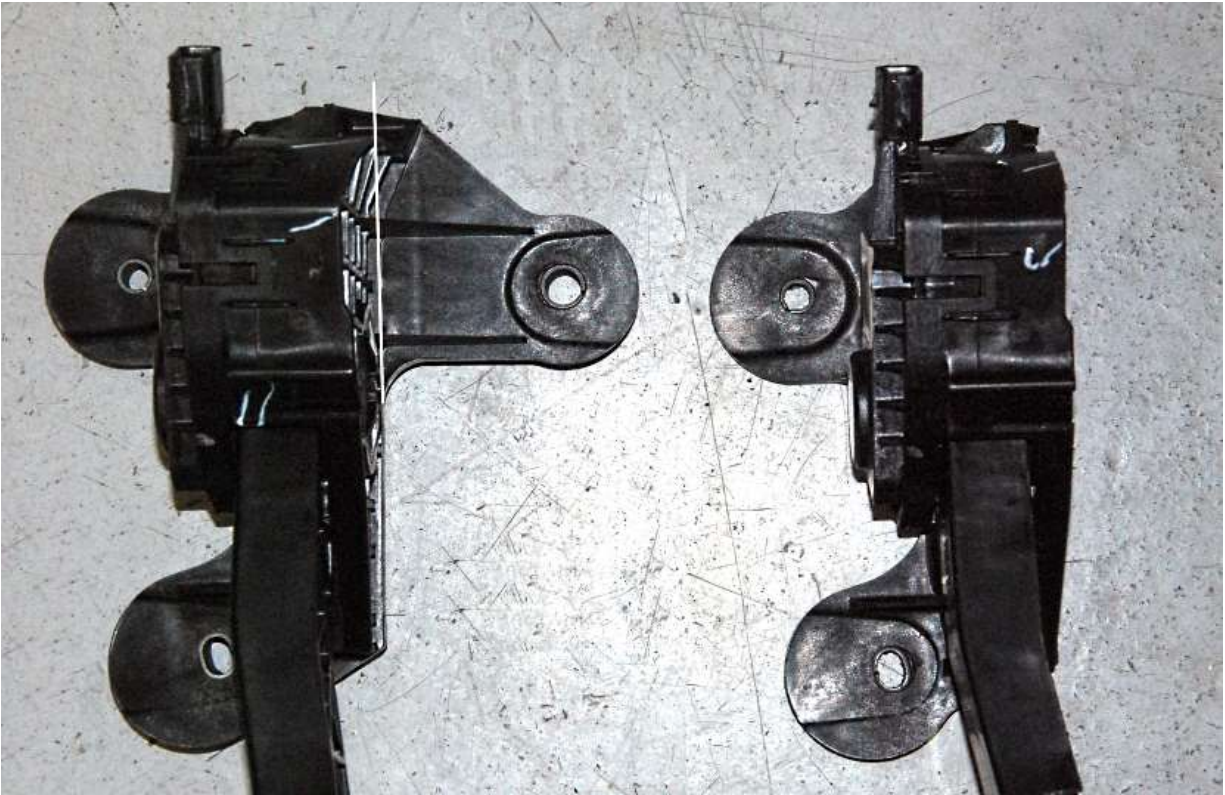

Use a hack saw to cut the right mount off the accelerator. Cut right against the flat section of the pedal so it also cuts the top Webbing off.



On the underside, cut the bottom mounts off with a hack saw so that the bottom is flat.



Use a T-25 torx bit and ratchet to remove the screw on the back of the accelerator pedal.





Turn the pedal pad around using the same screw hole.



Mark the pedal where the pad stops.



Cut the pedal with a hack saw then screw the pad back on.

Attach the accelerator pedal to the firewall using the 1/4" x 1" stainless screws, washers, 5/32" hex key and 7/16" wrench in the position desired that will clear the transmission tunnel.

## Exhaust

✂ 15mm, 17mm sockets, 15mm wrench

🚗 Coyote headers, straight pipes

👉 **The threads in the heads for the headers changed a couple times during production Be careful when installing the headers bolts so the threads are not ruined. After removing the headers studs, compare the thread to the new header bolts.**

Production header bolt change dates:

From 3-22-10 to 9-8-10 M10 x 1.50 Coarse

From 9-8-10 to 1-18-11 M10 x 1.25 Fine

From 1-18-11 M10 x 1.50 Coarse

FFR supplies the course bolts only. If the fine thread bolts are needed, the specifications you require when you purchase the bolts are: M10 x 1.25mm x 25mm long grade 8.8 hex head bolt

👉 Insert and tighten all of the bolts by hand before tightening any with a wrench.

Attach the headers to the engine.

Attach the connector pipes to the headers and kit exhaust system.



## Starting the engine

🚗 Oil, Coolant

If not already done, fill the engine with 8 quarts of the correct oil.



If not already done, fill the engine with coolant through an inline filler or radiator cap. To help remove air from the system, remove the top cap until coolant starts going up the tube then recap and hose clamp.

Fill the coolant overflow container.

Set the Fuel pressure regulator to the correct pressure as described in the Ford Racing engine control instructions.

Start the engine and allow the engine to get up to 195°F- 200°F then allow to cool completely, it will suck coolant from the overflow.

🖐️ Cooling fan is switched on at 195°F, turns off at 190°F. This is based on inferred engine coolant temperature. Engine coolant temperature is inferred from the cylinder head temperature. Inferred coolant temperature may not be the same as actual coolant temperature.

Once cool, check the radiator/inline filler neck and coolant overflow container. Top up with coolant if necessary.