



Factory Five Racing, Inc.

Part Number: 33871	Revision:1C	Effective Date: 11/2/20	By: J. INGERSLEV
Document Type (indicate):			
<input type="checkbox"/> Bill of Material	<input type="checkbox"/> Drawing (may be attached)	<input type="checkbox"/> Specification	
<input checked="" type="checkbox"/> Assembly Instructions	<input type="checkbox"/> Operating Procedure	<input type="checkbox"/> Other	

Hot Rod Gen 3 (2018) Coyote Engine

Installation Instructions



Table of Contents

Parts needed 3

 Ford Performance Parts 3

 Ford Motor Co. Parts 3

 Summit Racing 4

 Other vendors..... 4

 Autozone..... 4

Supplies 4

Information 4

Drivetrain prep..... 5

Flywheel removal	6
Exhaust	7
Oil System	7
Oil Cooler	8
Oil Pressure sender	9
Water Temp Sender	10
Oil filter relocater	14
Oil pressure sender/adapter	15
Relocator assembly.....	18
New flywheel/clutch.....	19
Torque Specs	30
Engine mounts	30
Engine Bolts.....	31
CMCV removal	31
Fuel Pressure sensor	35
Alternator Boss	37
Engine/Transmission Installation	38
Alternator	40
Fuel System	46
Fuel pressure regulator	46
Fuel lines.....	48
Fuel pressure regulator vacuum.....	49
Oil filter Relocator.....	50
Cooling system	51
Heater core bypass hose	56
Air Intake	59
Mass Air Meter.....	59
Intake tube	60
Vacuum ports and PCV vent	62
Valve cover hoses	63
Steering shaft	64
Clutch position switch	67
Accelerator Pedal.....	71
Wiring.....	75
Harness Prep	76
Intercooler wire.....	76
CAN Bus Wires	76
Computer mounting.....	77

Stock intake	77
Harness install.....	79
Cockpit.....	80
Engine bay	82
Mass Air Meter	83
Alternator	83
Radiator Cooling Fan.....	87
Battery power.....	88
Fuel Pump.....	89
OBD 2 Port	90
Start power.....	91
Tach	95
Autometer gauges	96
FFR vintage gauges	96
Oil Pressure and Water temp sensors	100
Clutch cable	101
Exhaust	102
O ₂ Harness	102
Starting the engine	106

Parts needed

Ford Performance Parts

M-6007-M50C - 5.0L Engine
 M-6017-M50B - 2018 newer 5.0L engine control pack
 M-7003-R58C - TKO transmission
 M-7771-A - Bellhousing bolt kit
 M-9680-M50B - 5.0L engine cover kit
 M-7007-A – Starter Index plate
 M-6392-M46 - Bellhousing
 M-6375-G46A - Flywheel
 M-6397-B46 - Clutch bolt kit

Ford Motor Co. Parts

F3LY-6C070-A - Flywheel access hole plug
 W500310.S438 - Starter bolts (3 needed)
 BR3Z-6379-A - Flywheel bolt (8 needed)
 AL3Z-6890-A - Oil filter nipple to eliminate oil cooler spacer plate. (if not using a relocater only) GR3Z-11002-A - 2016 Starter.



Summit Racing

Fuel System

👉 Ford Performance does not recommend the Corvette fuel filter/pressure regulator 👉
An alternative to buying all these items is the FFR 34423 EFI Inline fuel system

AEI-13129 – 6AN Fuel pressure regulator
SUM-220166B – 6AN O-ring to straight 6AN Adapter (2 needed)
SUM-220701-B – 6AN to -6AN Hose Barb (1 needed)
FRA-495110-BL – 6AN O-ring to straight -4AN Adapter (1 needed)
SUM-220700-B – 4AN Hose Barb (1 needed)
SUM-220711-B – 90° -6AN to -6AN Hose Barb (1 needed)
SUM-800199 – 0-100 EFI fuel pressure gauge
GSL392BX – Fuel Pump
VPN-400-939 – Fuel pump mount/barbs for GSL392BX pump

Oil Filter Relocator

👉 If using electric steering, this is needed. The oil filter will not clear the steering joint.

Air Intake System www.treadstoneperformance.com –

MAPHL4 or FFR 16941
FFR 16942 - 90° Silicone hose with fittings
FFR 16975 - Air filter

Other vendors

Autozone

👉 If running electric steering, an oil filter relocator with a M22 threaded spin on adapter is needed.
👉 If not running A/C, a small 1-wire alternator can be used in the stock compressor location. If A/C is being used, the following alternator can be used with the brackets described.

2001-03 Honda Civic DX 1.7L MFI SOHC Alternator – 12308
Hoses and fittings for Vacuum lines
Autometer Tach Adapter 9117 (Only if using Autometer Gauges)



Supplies

Oil – See instructions with engine - 8 quart
Coolant –2-3 gallons of **Dex-Cool concentrate**
Transmission fluid
Teflon tape

Information

👉 These instructions are for Gen 3 2018+ Coyote engines only. If using an older Coyote, download those instructions from www.parts.factoryfive.com/instructions .

- 👉 These instructions assume that the customer has the Coyote Installation kit from Factory Five Racing.
- 👉 Make sure to download the latest version of the engine controls instructions from the Ford Performance parts website: www.performanceparts.ford.com. Do a parts search for: M-6017-M50B and click on the instruction's pdf.
- 👉 The ECU has a base tune, it is strongly recommended to have the car dyno tuned after completion.

Use the following diagram as a guide for harness locations.

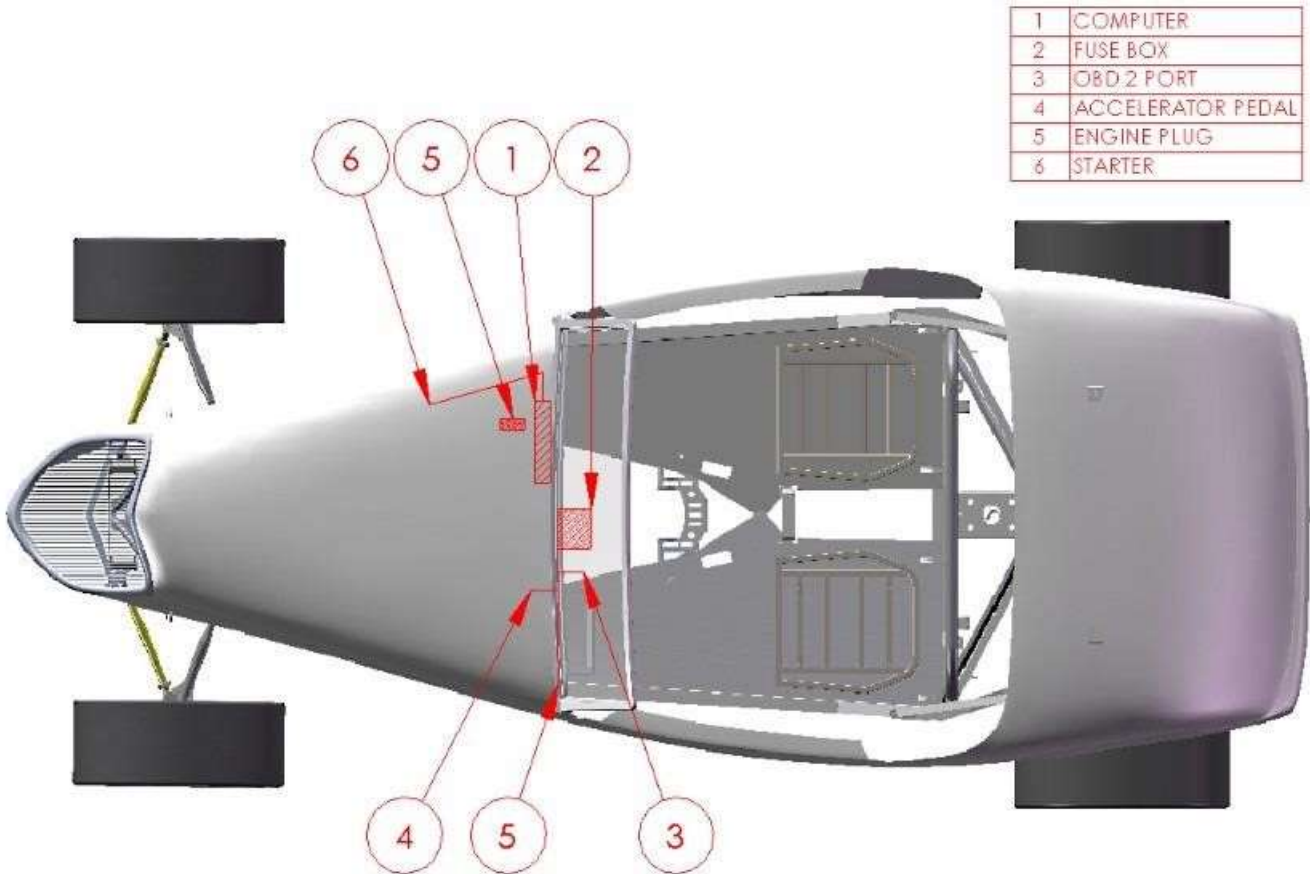

Drivetrain prep

- 🔧 6mm, 10mm, 13mm, 15mm, 19mm sockets, 13mm deep socket, ratchet
- 🔧 pipe fittings, Shallow oil pan
- 👉 Do not put the alternator on until after the engine is in.

Flywheel removal

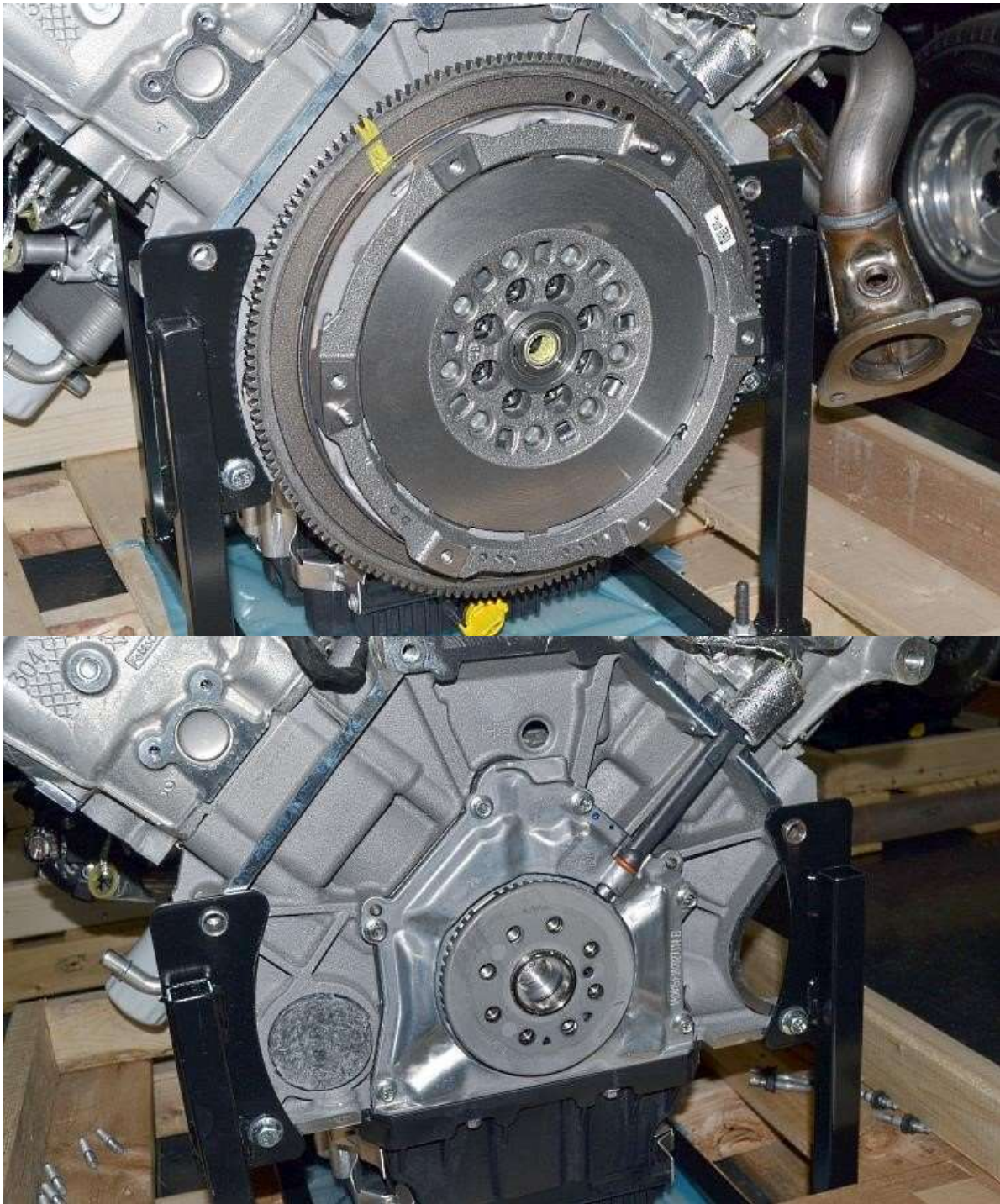

Use a 19mm socket and impact wrench to remove the flywheel that comes with the engine, it is not the correct type for the transmission used.

Discard the flywheel and bolts.

Exhaust



Remove the Stock Mustang header.



Remove all of the header studs using a 6mm 6 point socket.

Oil System



Morosso Oil pan, Oil pan sensor plug



Ratchet, $\frac{3}{8}$ " hex key or socket, ratchet



Blow the oil pan and pick-up out before assembling the pan to the engine to make sure there is nothing in them.

Use an engine hoist to lift the engine up off the shipping pallet.

Oil Cooler

✂ H14 Hex key, ratchet

✎ If Running Electric steering, an oil filter relocation kit will be needed. The oil filter will not clear the steering joint



Place a bucket or container to catch oil under the filter and remove the oil filter. This filter is too long and will not be used again.



Use an H14 hex key to remove the oil filter nipple and cooler. These will not be used again.

Oil Pressure sender



Remove the stock oil pressure gauge sender plug from the block located on the left front side of the engine.



Remove the wiring harness connector above the sending unit.

- ✎ The oil pressure sender will get installed after the water temp sender is installed.
- ✎ The Stock oil pressure sender is still needed for the best computer operation.

Water Temp Sender

- ✎ H14 Hex key or socket, 1¹/₁₆” socket, 7⁷/₈”, 12mm deep socket, extension, ratchet, Teflon tape 🛠
Water temp gauge sending unit.
- ✎ Autometer gauge sender shown, similar install for Vintage gauge sender.



Remove the $\frac{3}{4}$ " NPT plug from the side of the block using a H14 Hex key.



Use Teflon tape on the $\frac{1}{8}$ " NPT to $\frac{1}{2}$ " NPT adapter included with the gauge.



Use a vise to hold the large $\frac{3}{4}$ " to $\frac{1}{2}$ " NPT adapter then use a $\frac{7}{8}$ " wrench to put the two adapters together.



Screw the adapter into the block using a $1 \frac{1}{16}$ " socket.



Screw the adapter into the larger adapter on the block.



Put Teflon tape on the sending unit Autometer top, Vintage bottom



Use a $\frac{3}{4}$ " wrench to screw the sender into the adapters.

Oil filter relocater

- ✂ $\frac{5}{32}$ ", $\frac{3}{16}$ ", $\frac{3}{8}$ " Hex keys, 8mm socket, ratchet, Teflon tape, ratchet extensions, $\frac{9}{16}$ ", $\frac{11}{16}$ ", $\frac{7}{8}$ " wrenches, vise grips, Pipe fittings, oil filter relocater.
- 👤 If Running Electric steering, an oil filter relocation kit will be needed.
- 👤 Use a -10AN or -12AN adapter and hose.

Oil pressure sender/adaptor

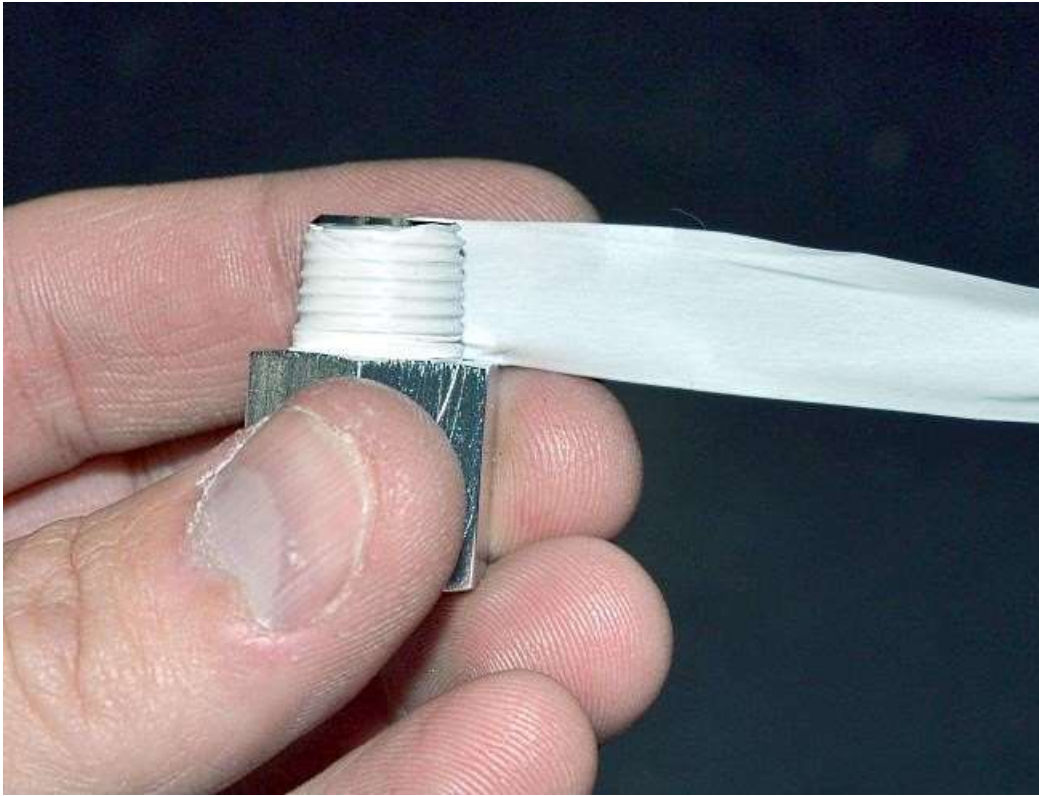

Put Teflon tape on all of the oil pressure sender pieces.



Attach and tighten the 90° fitting in the oil filter adapter so that the end sticks 90° out from the adapter.



Attach the “T” fitting with Teflon tape onto the 90° fitting.



Screw the gauge sender (Cluster gauge sender with adapters shown) into the side of the “T” adapter.



Attach and tighten the remaining NPT adapter and OE stock oil pressure sender to “T”.



If not already in, put the O-rings in the back side of the oil filter adapter.

Attach the adapter to the engine block.

Relocator assembly



Screw the threaded nipple into the relocator.

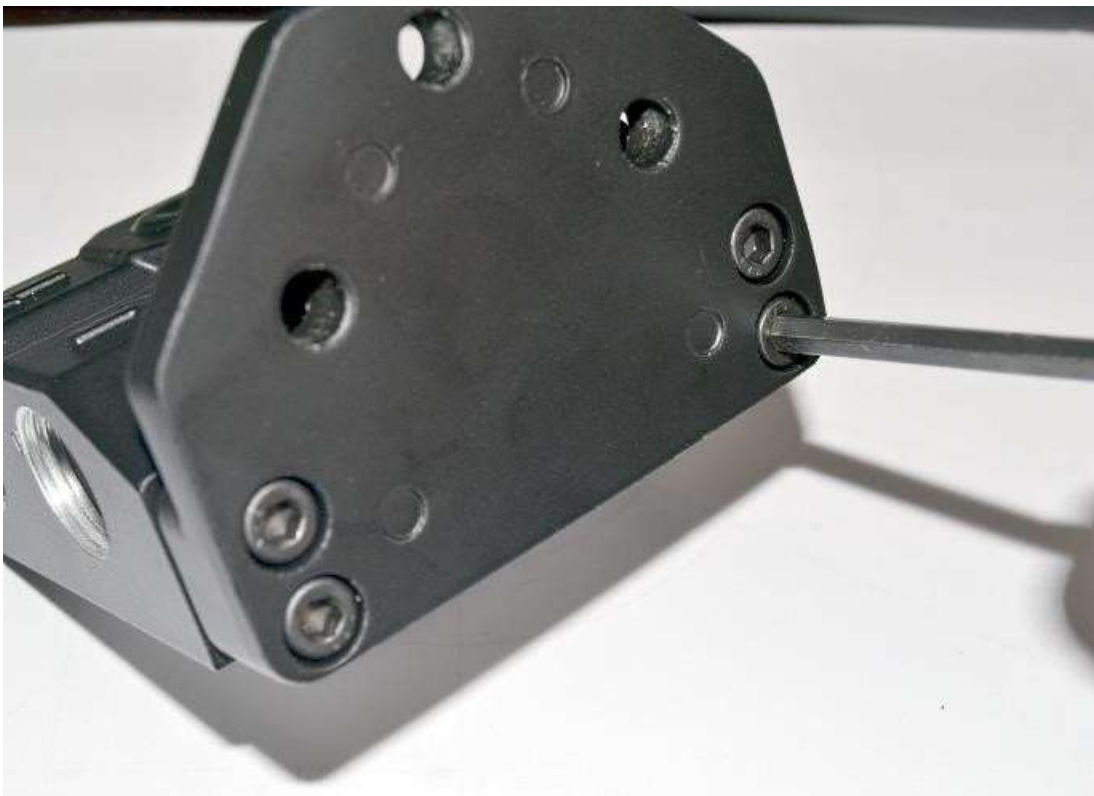

Use some Loctite and a $\frac{3}{16}$ " Hex key to screw the mount onto the relocator.



Use some Loctite and a $\frac{5}{32}$ " Hex key to screw the button head screws into the unused screw holes.

The relocater will get located once the engine is in the chassis.

New flywheel/clutch

- 🛠️ Flywheel, clutch set w/thrust bearing
- 🔧 Hammer, torque wrench, 19mm, $\frac{7}{8}$ " sockets, rag, brake cleaner.

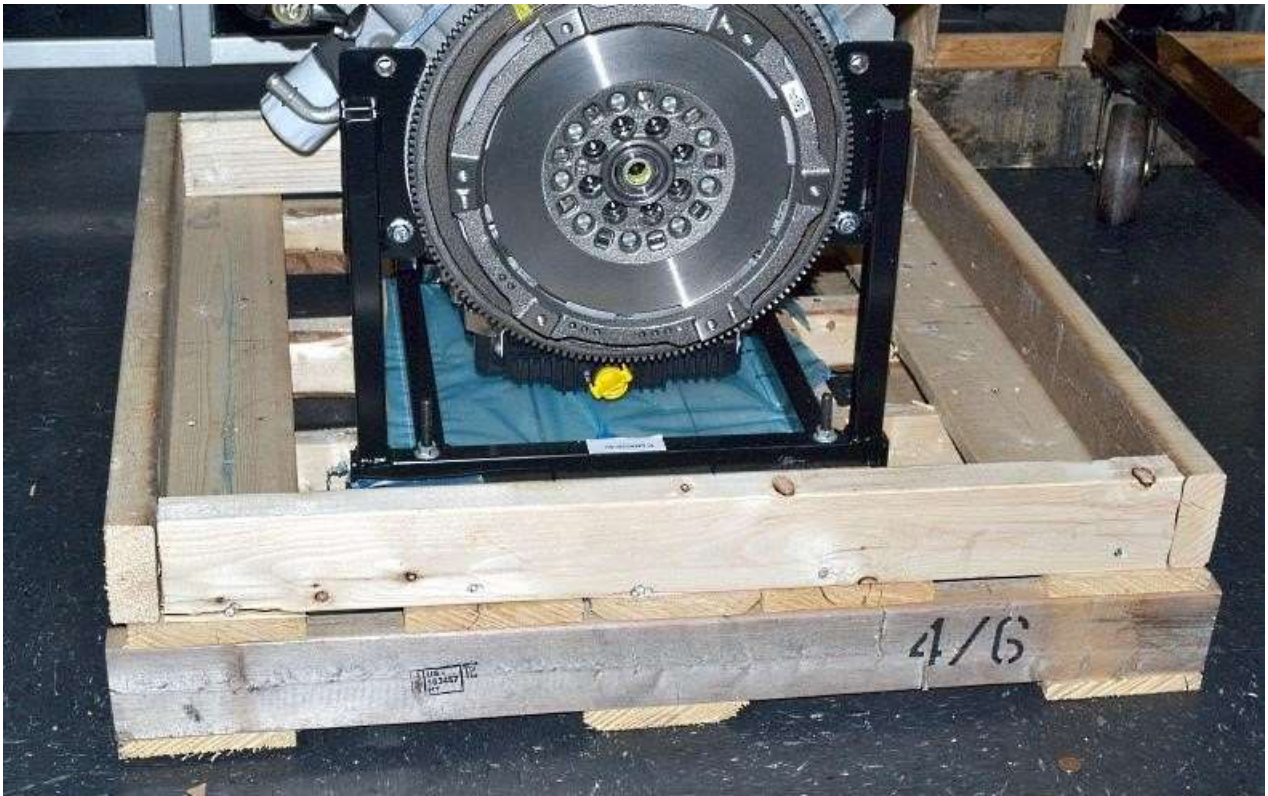

Remove the vertical 2"x 4" perimeter frame on the pallet



Set the engine down on the pallet so that the back of the oil pan is flush with the edge of the pallet.



Use a hammer and 7/8" or 22mm socket to hit the thrust bearing into the back side of the crank.



Put the inspection plate on the back of the engine.



Use a hammer to hit the clutch pins into the new flywheel.



Wipe the flywheel surface off with brake cleaner.



Attach the flywheel to the engine with a 19mm socket.



Use a screwdriver or punch through the flywheel into the starter opening of the inspection plate to stop the flywheel from turning while torquing the flywheel bolts to **80 Lbft.**

- ☞ We have found many of the aluminum bellhousings will hit the flywheel so it is important to check this in the next few steps otherwise the engine will not turn over.



Attach the bellhousing to the engine using a couple of the bellhousing bolts.



Look inside the bellhousing just above the clutch fork hole or try to turn the engine over using the crank bolt.



These marks show the interference of the flywheel and bellhousing.



Remove the bellhousing and use a grinder or file to remove material where the flywheel hits.



Use some engine oil to lubricate the thrust bearing. Make sure the oil does not leak down onto the clutch surface.



Put the clutch disc on with the alignment tool.



Put the pressure plate on the flywheel and torque the bolts to **35 Lbft** using a torque wrench.

Attach the pivot stud to the inside of the bellhousing using Loctite. Attach the clutch fork to the bellhousing.



Attach the bellhousing to the engine and **torque to 35 Lbft**.

Torque Specs

FLYWHEEL TO CRANK	80	Lbft
PRESSURE PLATE TO FLYWHEEL	35	Lbft
BELLOUSING TO ENGINE	35	Lbft

Engine mounts



Attach the engine mounts to the engine using the M10 x 25mm bolts provided with the engine mounts and a 17mm socket with ratchet. Don't forget to attach the engine ground strap to a right-side engine mount bolt.

Engine Bolts

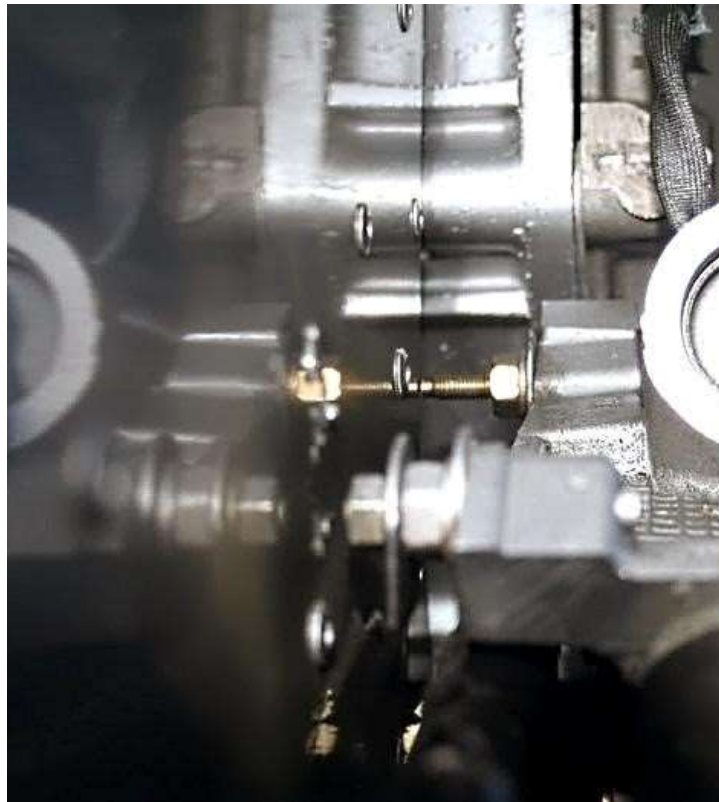

The engine ends up extremely close to the firewall. Cut any extra length off the bolts sticking out the back of the engine to prevent damaging the firewall.

CMCV removal

- 👉 Charge Motion Control Valve - These valves introduce tumble and swirl into the airflow at part throttle, maximizing combustion efficiency.
- 👉 The coyote install in the Hot rod is very tight against the firewall, the new CMCV's stick out past the back of the block and therefore need to be disabled.
- 🔧 T-25 Torx driver, snap ring pliers

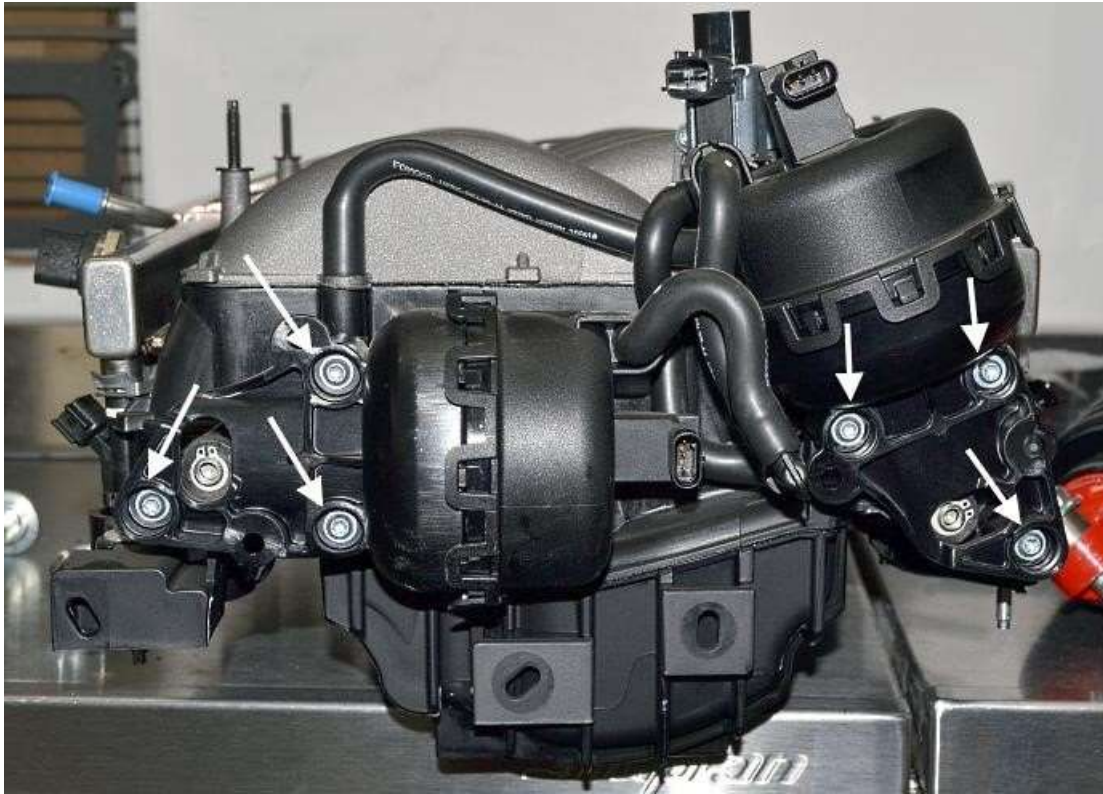

Locate the CMCV screws on the back of the intake.



Remove the screws using a T-25 Torx bit.



Remove the snap ring holding the CMCV to the intake shaft.



Remove the vacuum line going to the CMCV from the solenoid on the intake.



When standing in behind of the engine, on the left side put the end of the shaft through the hole in the shaft holder and attach the holder to the intake using the screws taken off earlier and a T-25 Torx bit.



When standing in behind of the engine, on the right side put the end of the shaft through the hole in the shaft holder and attach the holder to the intake using the screws taken off earlier and a T-25 Torx bit.

Cap the vacuum nipple on the CMCV solenoid.

Fuel Pressure sensor

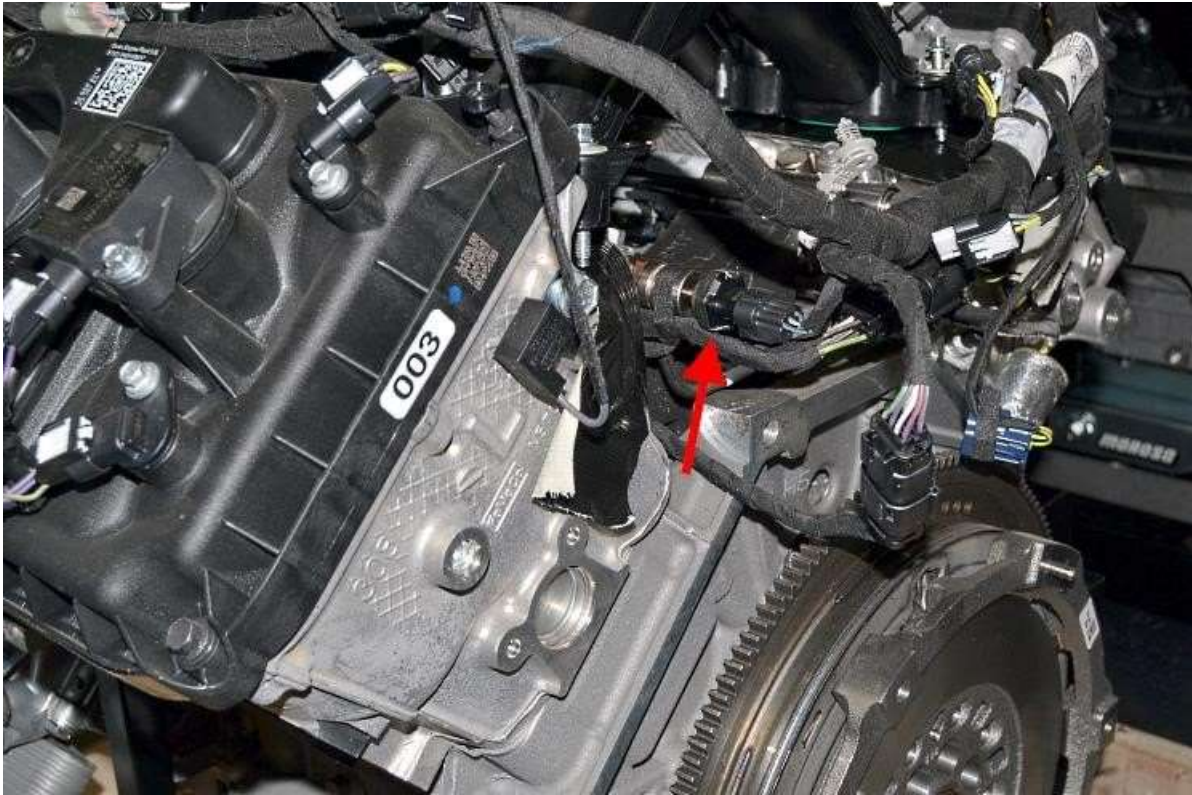

On the back left side of the engine on the end of the Direct Injection fuel rail is a Fuel pressure sensor.



Remove the fuel pressure sensor.



The plastic wire harness mount above and to the left of the fuel pressure sensor needs to be cut off in order to fit the sensor with the 90° adapter.





Cut the plastic intake with an air saw or metal saw.



Screw the 90° adapter into the fuel rail then screw the sensor into the adapter and replace the sensor plug.

Alternator Boss

-  Hack saw or jig saw
-  Use a hack saw or Sawzall with a course wood blade, a fine metal blade will get gummed up with the aluminum.



Use a Marker to mark the top stock alternator boss on the driver side as shown. It will hit the frame otherwise.



Cut the boss on the line marked with a jig saw.

Engine/Transmission Installation

If electric steering is installed, undo the mounting bolts and rotate the motor down out of the way.



Install the engine and transmission per the assembly manual.





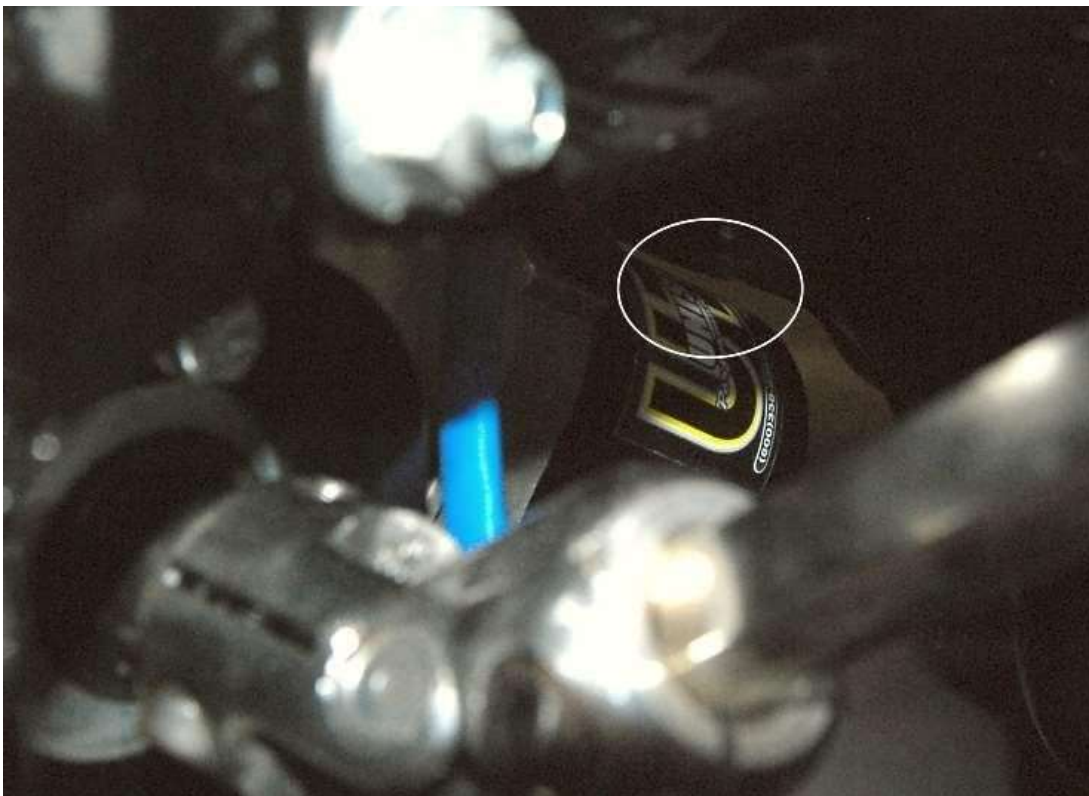

Attach the polyurethane transmission mount to the frame mount and transmission using the 1.09" and 0.32" spacers provided.



If using electric steering, reattach the motor mounting bolts. Make sure there is some clearance between the oil pan and motor. Redrill/slot one or two of the mounting holes if necessary.

Alternator

-  10mm, 13mm, (2) 17mm wrenches, 10mm socket, ratchet, wire stripper, wire crimper
-  Alternator, Alternator drive kit
-  The stock Alternator is designed to run counter clockwise and the frame goes through the stock location so it cannot be used. With the internal fan curve direction of the stock Alternator, there is a possibility that the Alternator could overheat when run in the opposite direction.
-  The Honda alternator runs clockwise and when run in the orientation we use it is run the correct way.

ITEM NO.	PART NUMBER	DESCRIPTION	QTY.
1	33824	ALTERNATOR MOUNT BRACKET	1
2	HONDA ALTERNATOR		1
3	33828	1.18" SPACER	1
4	33827	1.00" SPACER	2
5	33825	3.37" SPACER	1
6	33826	3.48" SPACER	1
7	hex cap screw_0m	M10-1.5mm x 110mm HEX HEAD CAP SCREW	1
8	B18,23,14M - Hex cap screw, M10 x 1.5 x 65 - 245		1
9	M10F	NUT NYLOC M10 TYPE F	1
10	hex cap screw_0m	M8-1.25mm x 140mm HEX HEAD CAP SCREW	2
11	B18,23,14M - Hex cap screw, M8 x 1.25 x 80 - 22N		1

REV.	REVISION DESCRIPTION	DATE	APPROVED
A	INITIAL RELEASE	1/20/15	

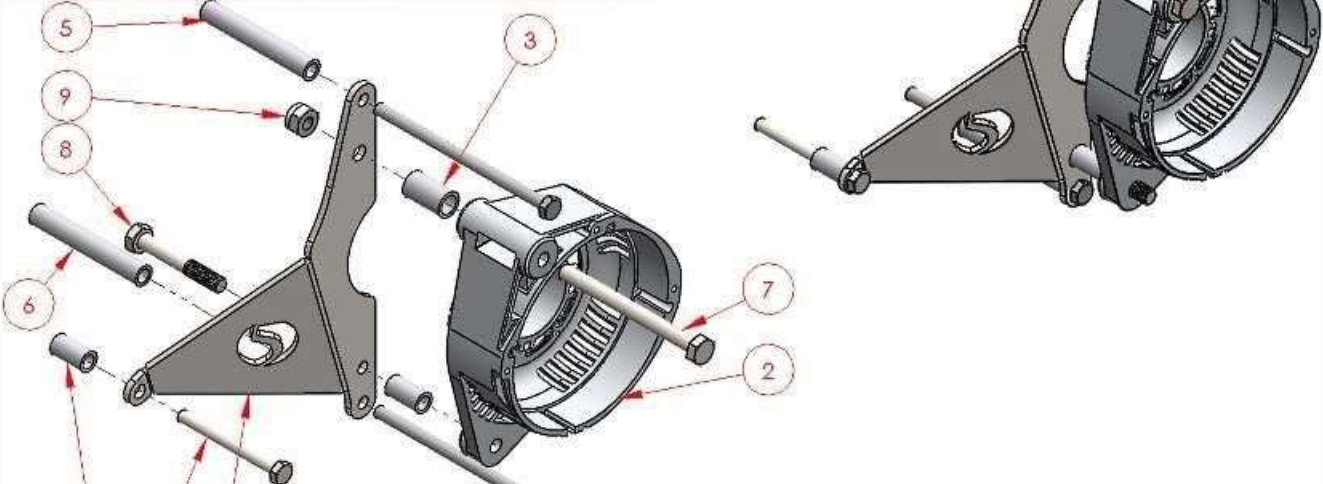

PROPERTY AND CONFIDENTIAL
THE INFORMATION CONTAINED IN THIS DRAWING IS THE SOLE PROPERTY OF FACTORY FIVE RACING, INC. ANY REPRODUCTION IN PART OR AS A WHOLE WITHOUT THE WRITTEN PERMISSION OF FACTORY FIVE RACING, INC. IS PROHIBITED.

UNLESS OTHERWISE SPECIFIED:
DIMENSIONS ARE IN INCHES
TOLERANCES
TWO PLACE DECIMAL ±0.01
THREE PLACE DECIMAL ±0.005
FOUR PLACE DECIMAL ±0.001

MATERIAL
FINISH

USED ON
APPLICATION

DRAWN	NAME	DATE
JL		2/5/15
COMMENTS		

TITLE:
HOT ROD COYOTE ALTERNATOR DRIVE

SIZE	DWG. NO.	REV
A	33830	A

PRINTED: 1/20/2016

SCALE: 1:3 WEIGHT: SHEET 1 OF 1



Put the large long bolt through the alternator and place the spacer on the bolt.

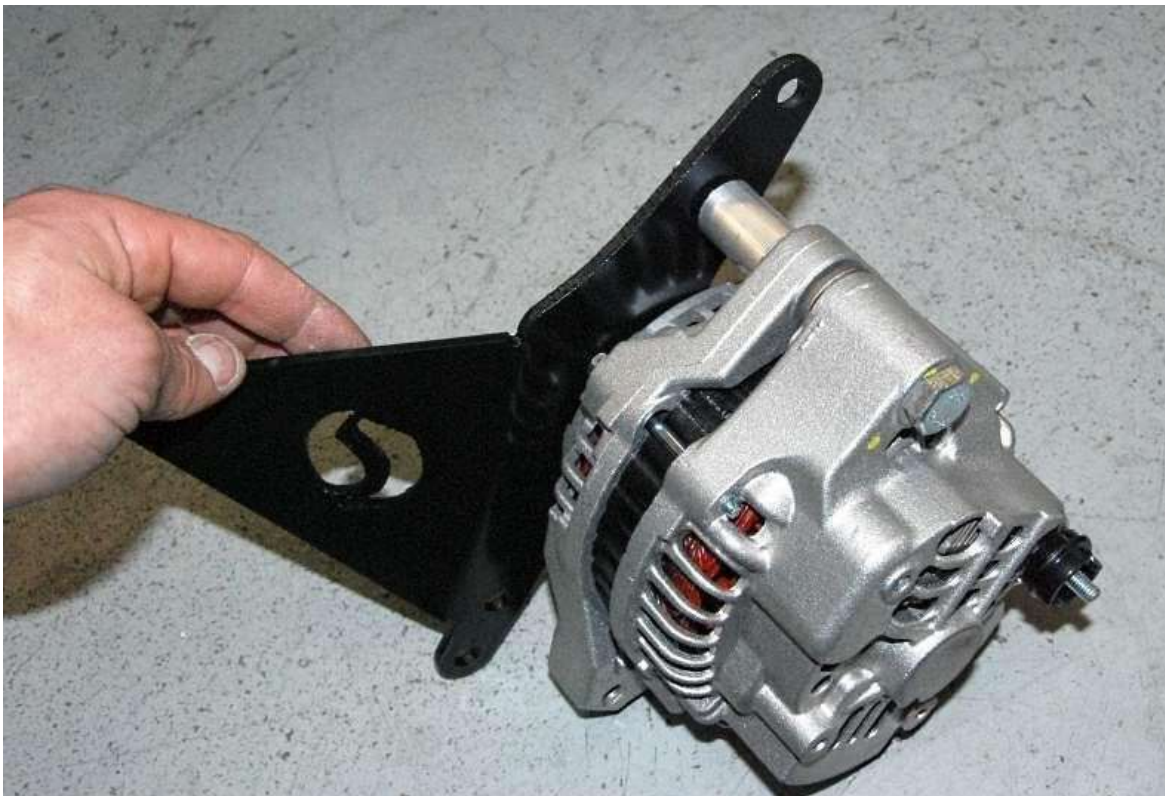

Attach the alternator to the mounting bracket leaving the nut so that the alternator can rotate.

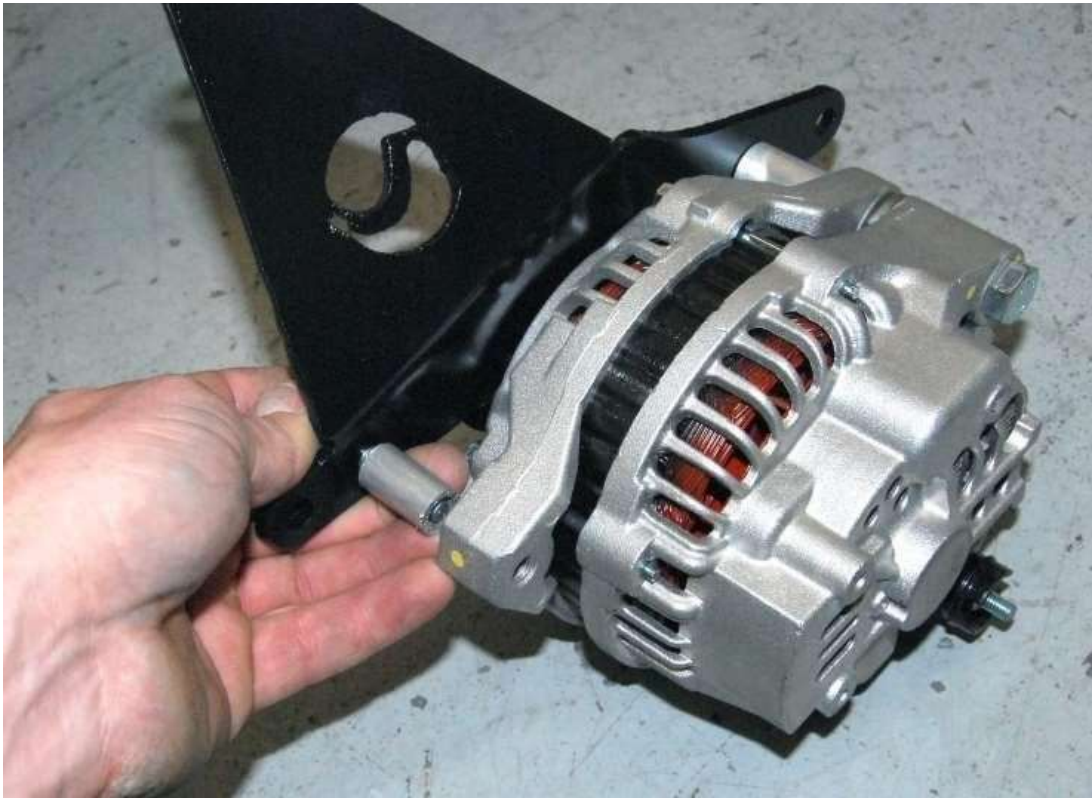

Pass the short bolt through the other bracket mounting hole and place the small ID spacer on the bolt.

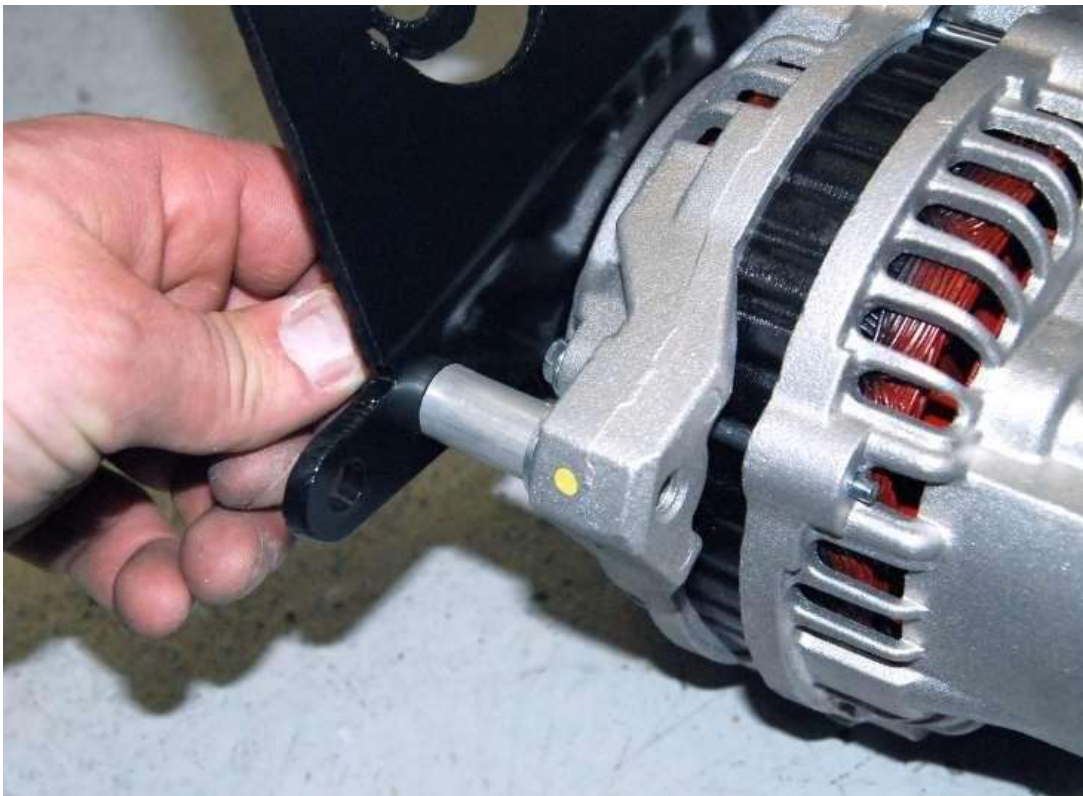

Thread the bolt into the Alternator.

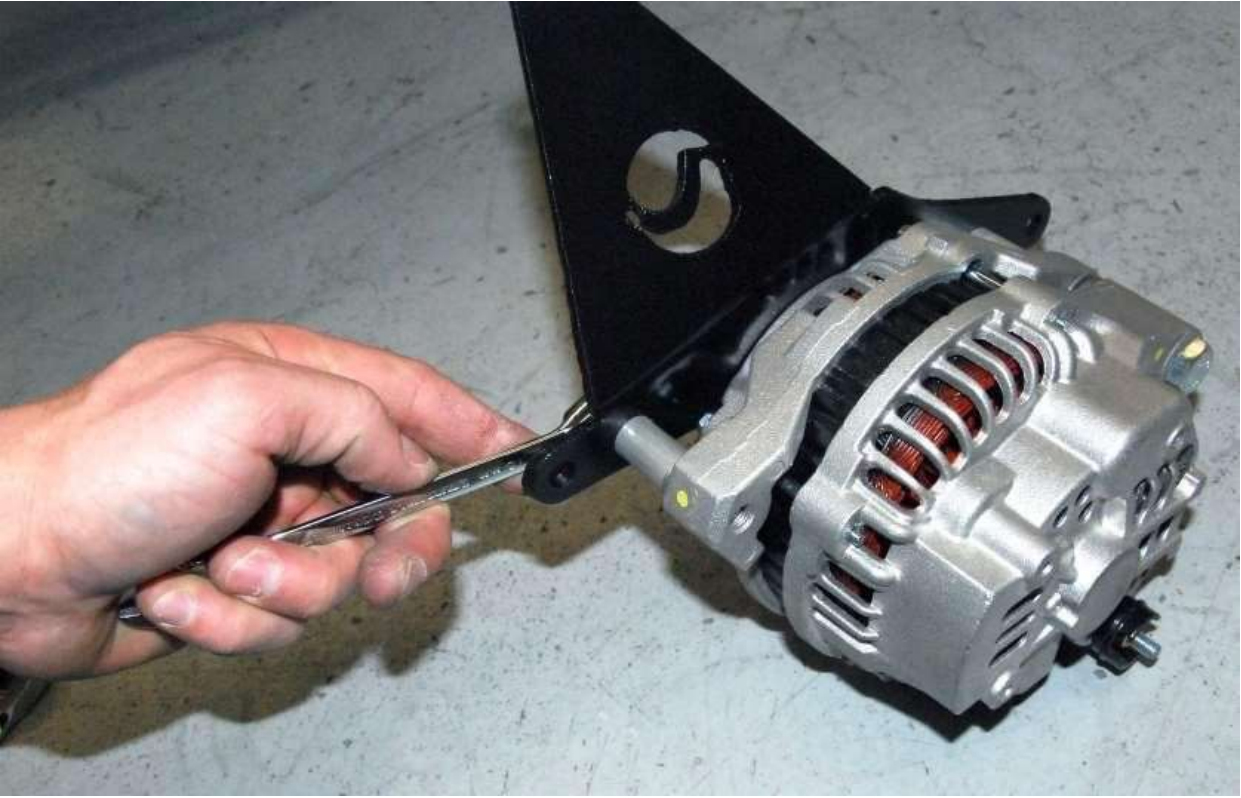

Tighten the alternator mounting bolts.



Run the bracket mounting bolts through the bracket and put the spacers on the bolts.

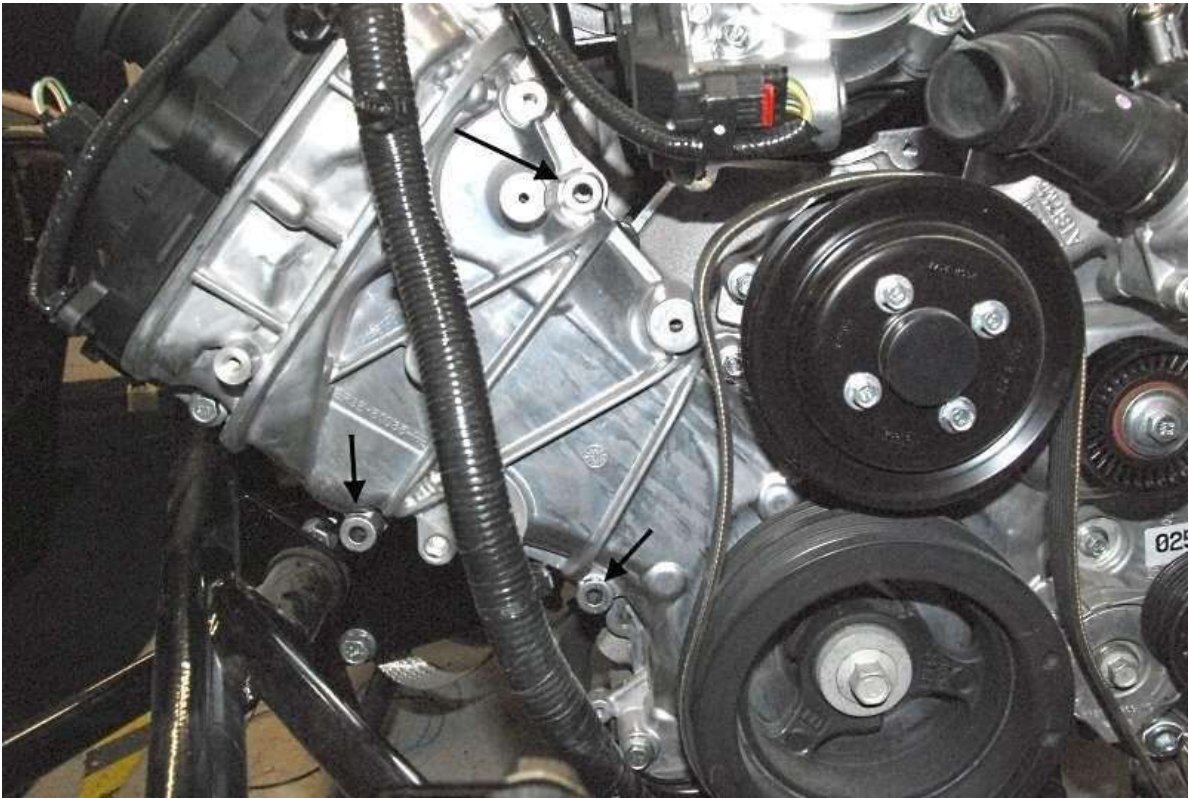

Remove the timing cover screws at the points shown in the picture above.



Attach the mounting bracket to the engine keeping the engine control harness behind the bracket. Belt Tensioner



Ratchet, 15mm socket, vise.



The bolt holding the pulley is left hand thread, do not turn it the wrong way.



Remove the bolt holding the pulley and remove the smooth pulley.





Replace the smooth pulley with the ribbed pulley included. Do not use the metal cover from the smooth pulley.



Attach the belt tensioner to the timing chain cover and tighten to 18 Lbft (25Nm) then route the belt as shown.

Fuel System

-  Fuel pressure regulator, fittings, fuel hose, hose clamps, high pressure fuel pump
-  The Coyote engine requires a 255 lph high pressure fuel pump such as a Walbro GSL 392 Fuel Pump or use the FFR inline Fuel system.
-  Factory Five offers a complete fuel system for the Coyote including fuel pump, AN fuel lines, fittings, regulator and charcoal canister.

Fuel pressure regulator



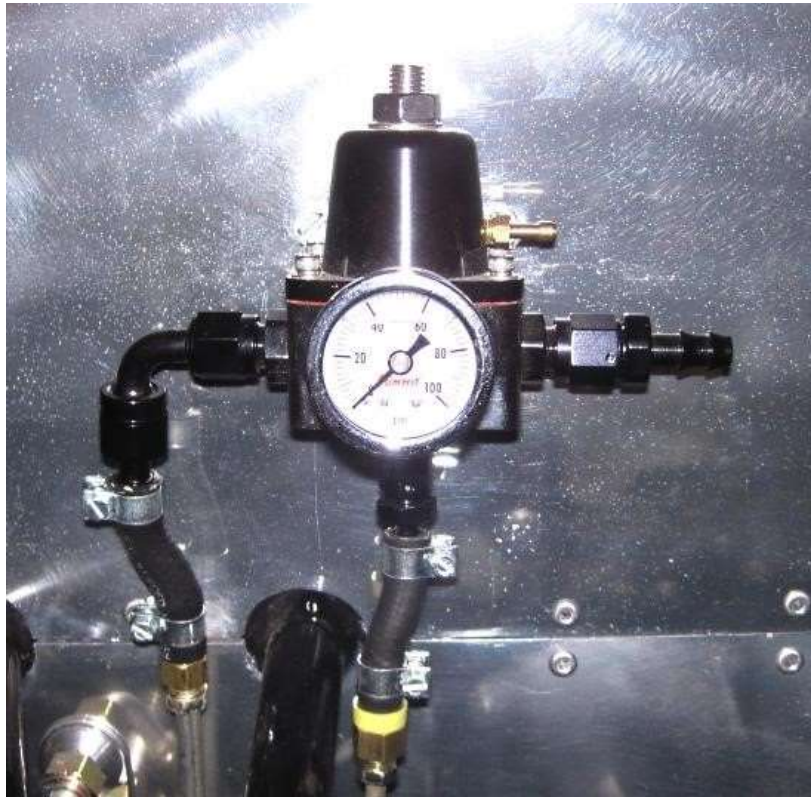

Mount a fuel pressure regulator to the firewall and connect the appropriate fittings, the return is on the bottom.



Push the $\frac{3}{8}$ " fuel line onto the right side of the regulator then attach a hose clamp and run it over to the engine fuel rail.

Fuel lines



Push the white fuel line connector onto the fuel rail.

Hold the fuel line up to the connector and cut it to length with a razor knife.

Remove the fuel line connector.

Slide a hose clamp onto the hose then push the fuel line connector into the hose and tighten the clamp.



Push the white connector onto the fuel rail.

Fuel pressure regulator vacuum



Push the 90° fitting with the small barb onto the smaller connection behind the throttle body.

Push the vacuum line onto the barb.



Run the vacuum line to the fuel pressure regulator then cut and push it onto vacuum barb.



Use one of the small kit zip ties to make sure there is a good seal on the regulator vacuum hose.

Oil filter Relocator



Locate the filter relocater under the steering rack or a similar place to allow a straight shot for the hoses to the filter spin-on adapter (old relocater shown).

Cooling system

- ✂ Razor knife, flat head screwdriver, wire cutters, hack saw, marker, $\frac{5}{16}$ " socket, ratchet.
- 🔧 Stainless radiator hose kit



Push the correct size adapters onto to the thermostat housing with a length of the stainless hose.



Route the stainless hose to the left side lower radiator outlet and mark the hose for cutting.

Remove the stainless hose and cut it where marked with a hack saw. Reinstall the hose.



Cut the plastic clamp off the stock upper hose.



Cut and remove the rubber hose from the plastic adapter.



Attach one of the kit hose adapters to the plastic adapter



Push the adapter onto the engine.



Attach another hose adapter to the radiator.



Route and cut the radiator hose so that the hose curls towards the right side of the car not the left (the air filter goes there). Push the bypass caps onto the tubes to the left of the throttle body and hose clamp the lower one.

- ✎ For air bleeding later, remove the top cap until coolant starts going up the tube then recap and hose clamp.
- ✎ This top one is one of the heater core hose locations if running a heater and A/C.



Push the bypass caps onto the lower tube to the left of the throttle body and hose clamp it.

Heater core bypass hose

- 👉 If running a heater or A/C, do not push the spacer into the tube in the next step.
- 👉 If running a heater or A/C, this is the tube that the heater core would get plumbed into.

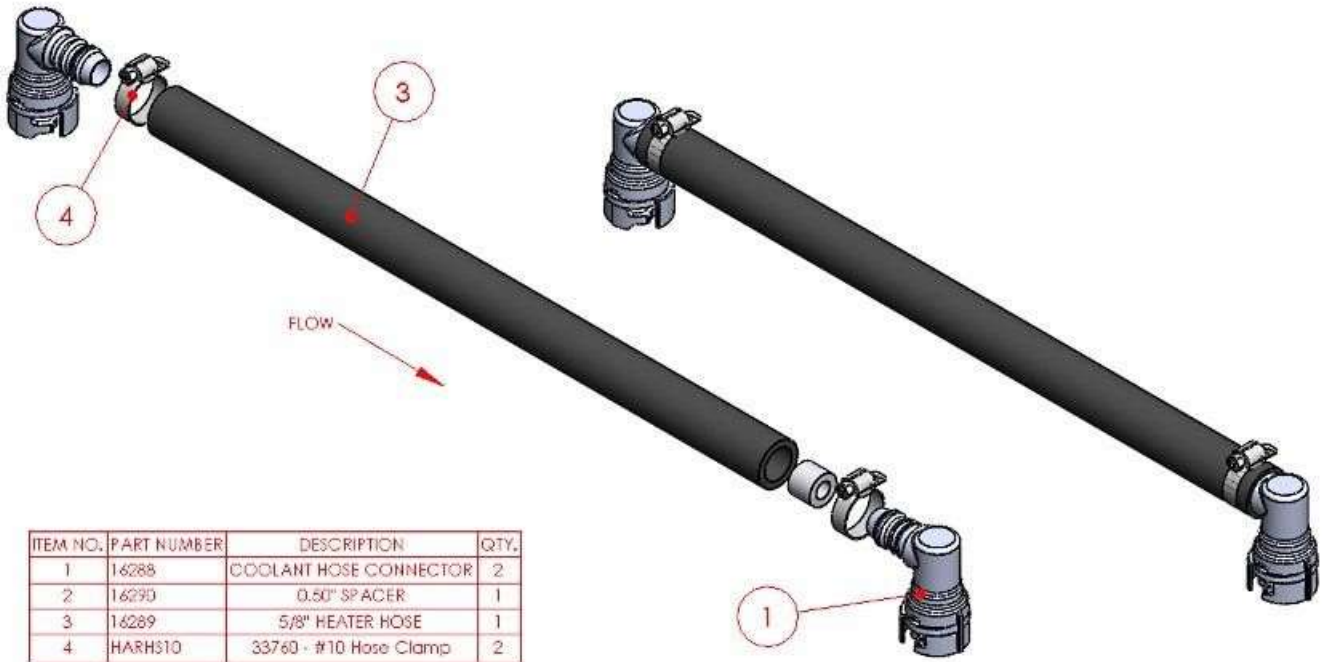

Assemble the right side of the heater bypass hose, insert the 0.50" aluminum spacer into the 5/8" heater hose followed by a hose clamp then push one of the 90° plastic coolant hose adapters.

Tighten the hose clamp using a $\frac{5}{16}$ " socket and ratchet.



Push the hose onto the top of the tube to the left of the throttle body.

Push the other adapter onto the tube on the right side of the intake then measure and cut the $\frac{5}{8}$ " heater hose so that it will connect to the adapter and route where desired.



Put a hose clamp on the hose, push it onto the coolant adapter and tighten the hose clamp.

- ✎ For air bleeding later, remove the 90° plastic coolant hose adapter until coolant starts going up the tube then recap and hose clamp.
- ✎ This top one is one of the heater core hose locations if running a heater.



Push and hose clamp the small coolant barb behind the 3/4" coolant tubes.

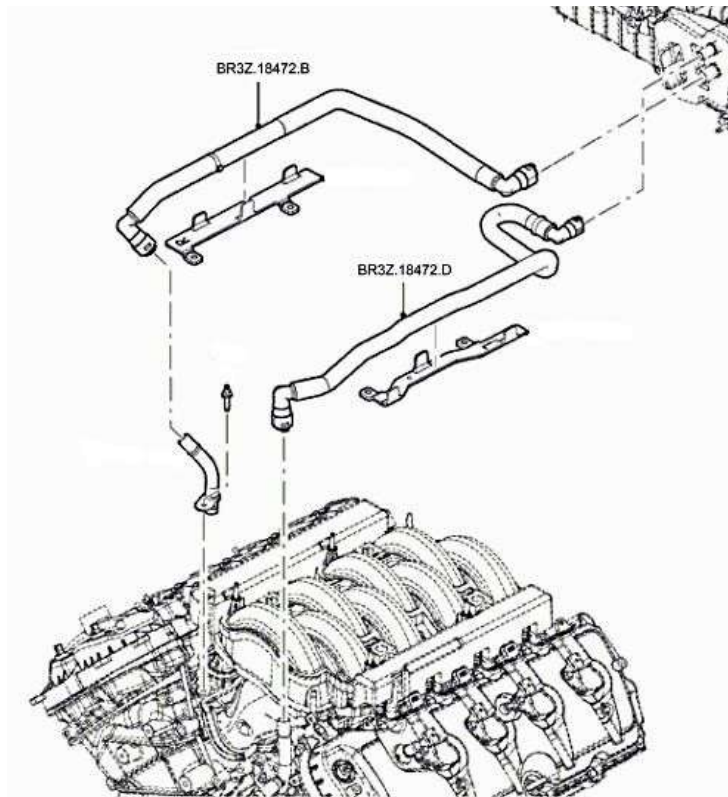

- 👉 If running a heater or A/C, use the bypass hose connectors and some heater hose to connect to the heater.

Air Intake

Mass Air Meter

- 🛠️ Mass air meter, silicone hoses, intake tubes, air filter
 - 🔧 T-20 Torx driver, Flat head screwdriver, Philips head screwdriver, sensor safe RTV silicone 👉
- Make sure the Mass Air meter is pointed in the correct direction.



Unscrew the mass air sensor from the Ford intake using a T-20 Torx driver



Remove the sensor and note the direction of the curved part of the sensor.



Install the sensor on the mount using the short screws so the flat side of the sensor will face the air filter.

Intake tube



Make sure the Mass Air meter is pointed in the correct direction.



Push the FFR filter onto the Mass Air meter making sure that the meter is facing the correct direction. Slide hose clamps onto the 90° Silicone hose.



Push the small end of the silicone hose onto the throttle body.

Push the mass air meter into the silicone hose.

Adjust the Mass air meter so that the mass air plug is on the far side as the Ford Performance instructions recommend.

Tighten the hose clamps

Vacuum ports and PCV vent

- ✂ Flat head screwdriver, razor knife, WD40
- 🔧 Vacuum plugs, PCV lines, ½" rubber hose, T connector



On the front of the intake manifold, push the 3/8" Vacuum cap onto the vacuum barb.



Block off the large vacuum port just behind the throttle body.

Valve cover hoses



If not already done, connect the right side stock PCV hose from the valve cover to behind the throttle body.



Attach the fitting to the left side valve cover.



Attach the other end of hose to the adapter on the silicone hose.

Steering shaft

✂ Hack saw, $\frac{7}{16}$ " socket, ratchet, $\frac{3}{16}$ " drill bit, drill, $\frac{3}{16}$ " hex key 
Hot Rod steering parts.

✎ This is only for using the shorty headers. The full length headers do not need this steering shaft setup.

Remove the middle steering shaft that goes from the firewall to the lower steering bearing in the engine bay. Cut the shaft into two sections, 8 $\frac{7}{8}$ " for the lower shaft and 4.25" for the upper shaft. Assemble the two shaft pieces with the included steering joint with the short half of joint on the long shaft. Slide the $\frac{3}{4}$ " pillow block onto the long shaft with the bearing lock pointed away from the steering joint. Assemble the shaft on the frame so that the ends of the shafts are flush with the inside of the joint. Loosely attach the tube clamps to the 1" round tube near the steering shaft.

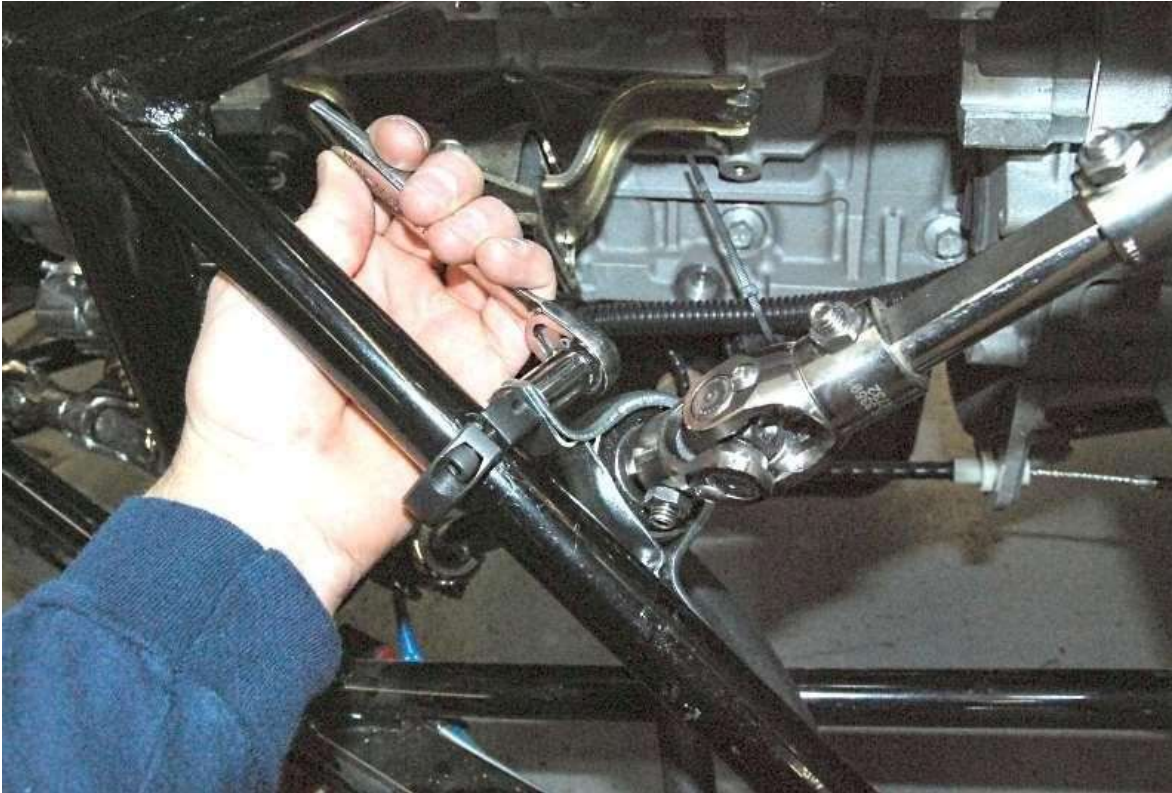

Loosely attach the pillow block to the tube clamps, the screws will not tighten because of the tube.



Locate the tube clamps on the tube so that the shaft is as straight as possible and then tighten the clamps.

Remove the pillow block screws and use a marker or small drill bit through the screw hole to mark the location on the 1" tube.

Remove the tube clamps.



Drill the marked locations using a 1/4" drill bit. This will allow the pillow block mounting screw to go into the tube and also prevent the tube clamps from turning or moving if they loosen for some reason.

Reassemble the tube clamps and pillow block on the tubes using the pillow block mounting screws in the drilled holes to locate them.



Tighten the set screws on the steering joint and pillow block.

Clutch position switch

 Ford Performance bottom travel switch, coyote clutch switch components. 
 $\frac{1}{2}$ " , $\frac{9}{16}$ " wrench, $\frac{1}{2}$ " socket, Ratchet, $\frac{3}{16}$ " , $\frac{5}{16}$ " hex keys.

 The install is shown outside the footbox for better pictures.

Remove the clutch cable from the quadrant.

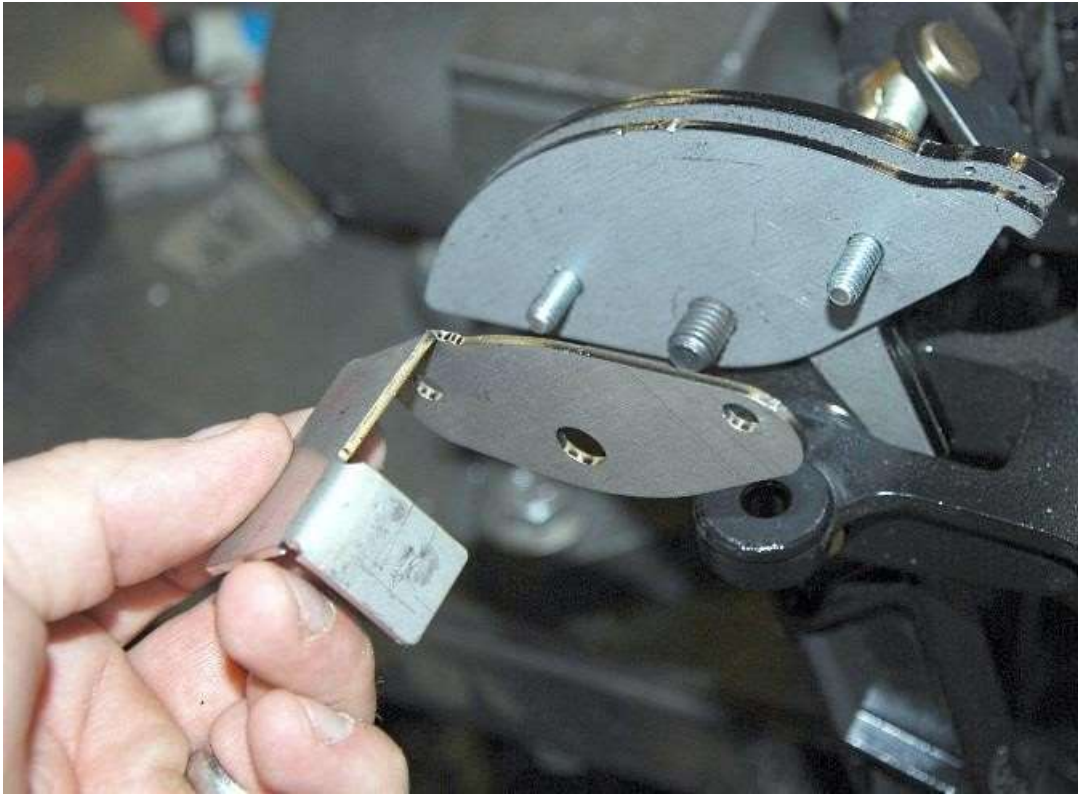

On the clutch pedal, remove the last $\frac{1}{8}$ " clutch quadrant end plate and replace it with the stainless bottom switch clutch quadrant plate.



Tighten the locknuts.

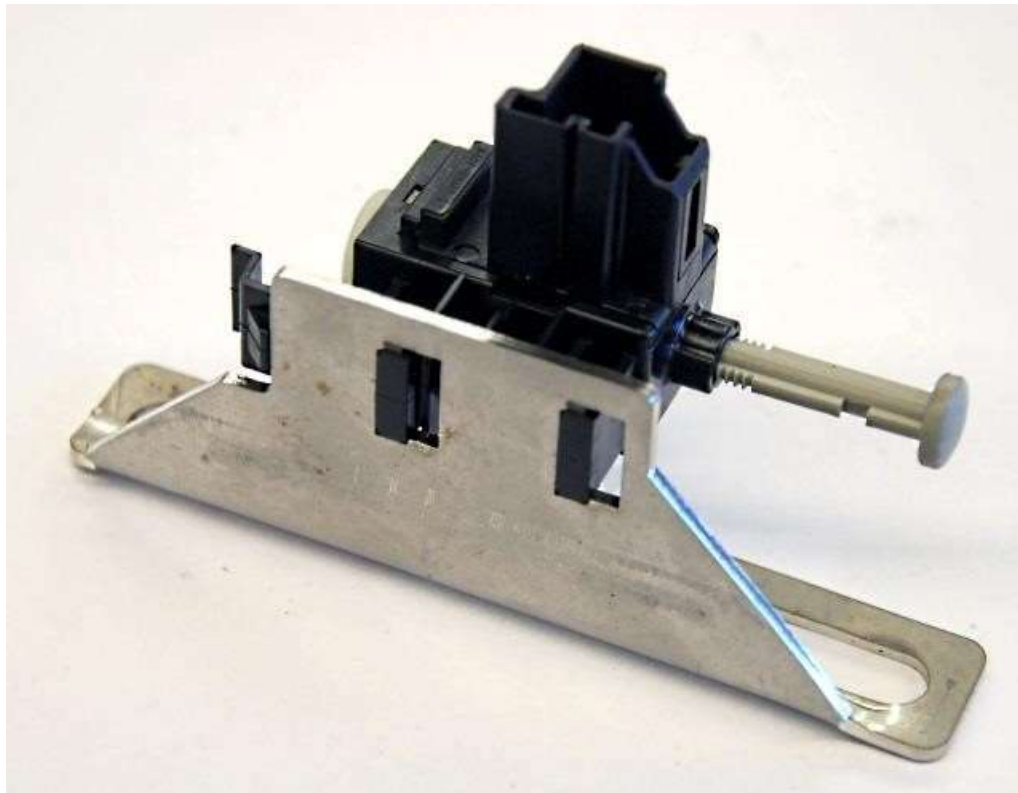

Attach the Bottom travel (gray plunger) clutch switch to the bottom travel switch mount as shown.
Remove the bolts holding the left side of the pedal box to the mount bracket.



Insert the new $\frac{5}{16}$ " x 1.25" bolts through the bottom travel switch mount then through the pedal box bracket and pedal box.



Attach the top travel clutch switch bracket to the bottom of the bolts.



Snug the bolts up with a 1/2" wrench and socket so the bottom travel switch bracket can still move.

Reattach the clutch cable to the quadrant.

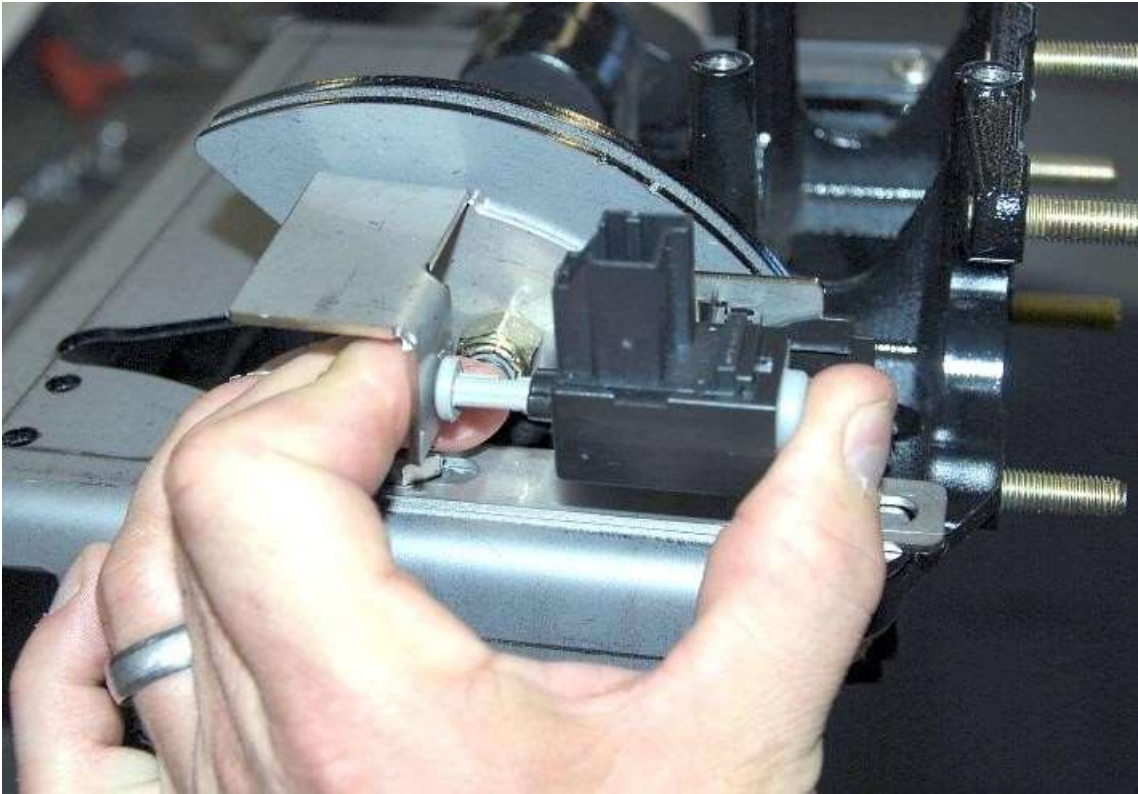

Have someone push the clutch pedal all the way in then slide the bottom travel switch mount so that the bottom travel switch is pressed in all the way against the quadrant plate. Hold the switch mount so that it does not move and let the clutch out then tighten the pedalbox mount screws with a 1/2" wrench and socket making sure the switch mount does not move.

Check the throw of the clutch pedal again carefully. The switch should get pressed in all the way but should not get pushed hard enough to stress/move the body of the switch.

Accelerator Pedal

✂ Hack saw, T-25 Torx bit, ratchet, 7/16" wrench, silver Marker, Grinder or drill bit, clamp 🚗
Accelerator pedal, coyote accelerator install kit

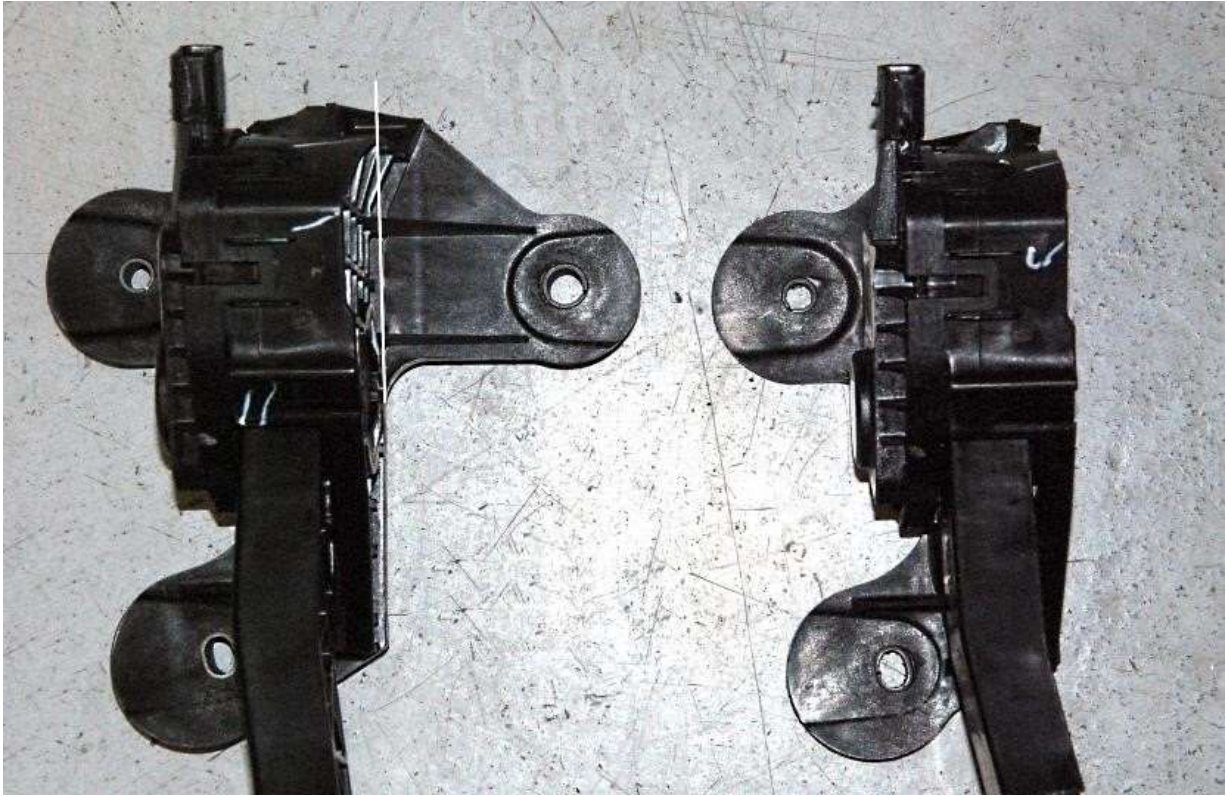

Use a hack saw to cut the right mount off the accelerator. Cut right against the flat section of the pedal so it also cuts the top Webbing off.



On the underside, cut the bottom mounts off with a hack saw so that the bottom is flat.



Use a T-25 Torx bit and ratchet to remove the screw on the back of the accelerator pedal.



Turn the pedal pad around using the same screw hole.





Mark the pedal where the pad stops.



Cut the pedal with a hack saw then screw the pad back on.

Attach the accelerator pedal to the firewall using the $\frac{1}{4}$ "x 1" stainless screws, washers, $\frac{5}{32}$ " hex key and $\frac{7}{16}$ " wrench in the position desired that will clear the transmission tunnel.

Wiring

-  Soldering iron, solder, electrical tape, wire cutters, wire strippers
-  Use the diagram at the beginning of these instructions for general routing and component location.

Harness Prep

Intercooler wire



Cut the red and black Intercooler pump wires back to the Y in the harness. They are not needed or used. Tape the ends separately so they will not ground then tape them to the harness.

CAN Bus Wires

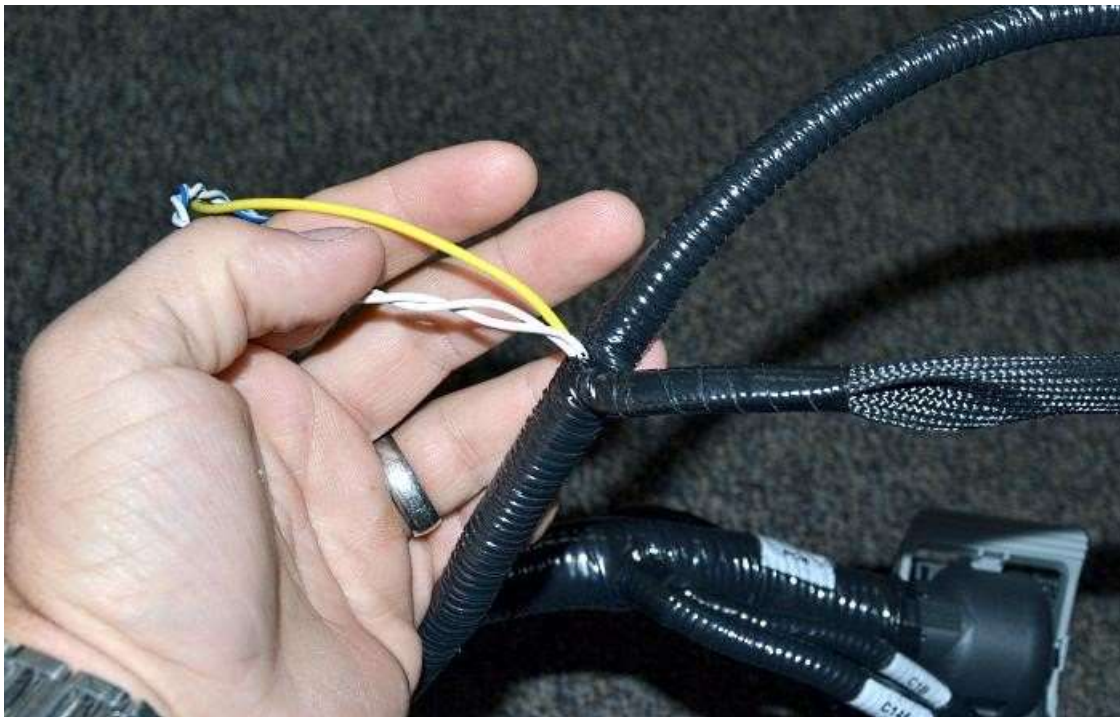

Next to the starter wire, cut the yellow and twisted CAN Bus wires back to the harness. They are not needed or used.

Computer mounting



Depending on the intake being used the computer can get mounted in different places, under the intake like the picture above with a Holley Sniper intake or on the firewall with a stock intake.

Stock intake



Connect the engine mounted harness to the computer.



In order to reach the firewall, the harness needs to get double backed on itself being careful not to pull out the sensor wires on the plug shown above. If necessary, extend the wires.



Locate and mount the computer so that the engine plug will reach.



Connect the Control pack plug to the computer.



Connect the 16 pin Engine harness plug to the control pack plug next to the computer.

Harness install

- 👉 Use the diagram at the beginning of these instructions for general routing and component location.
- 👉 The grommet on the harness is in the wrong location for use in the Hot Rod and can be cut off

Cockpit

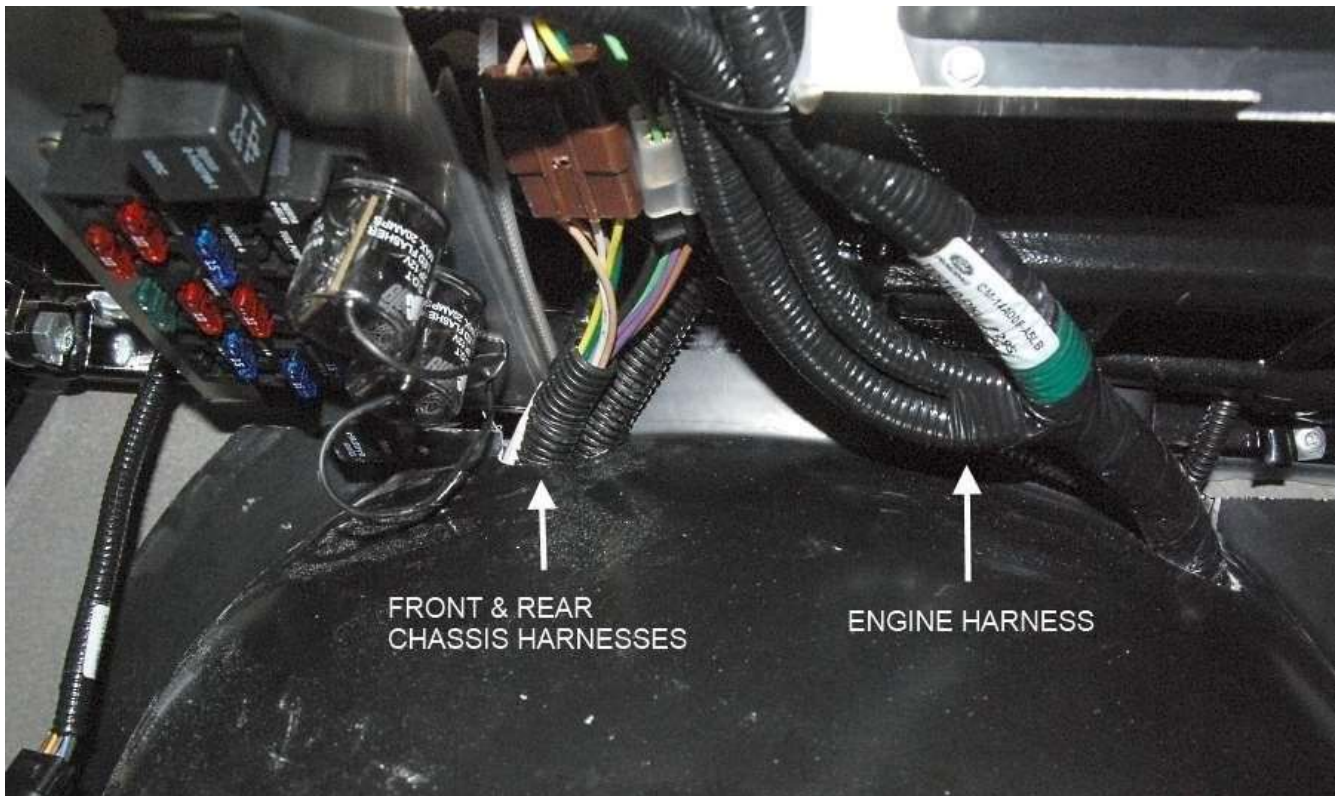

The main engine wiring harness should enter the cockpit towards the right side of the transmission tunnel.



Mount the fuse panel to the chassis towards the middle if you are running A/C.

In the cockpit, run the wires across to the driver's footbox.



Connect the Accelerator pedal lead (APPS) to the pedal.

Connect the clutch pedal travel switch lead to the switch.



Connect the 6-way connector on the harness to the 6-way connector pigtail with the green wire.

Engine bay



Run the Alternator/Mass Air long harness leg across to the engine with the engine harness then to the back of the engine.



Run the harness leg across to the left side then to the front of the engine on the left side.

Mass Air Meter



Plug the mass air meter connector into the mass air meter.

Alternator



Run the red chassis harness alternator wire under the firewall up to the right side of the engine.
Run the alternator wire to the front of the engine next to the engine harness.



Run the alternator wire down to the alternator output post.

Cut the wire to length and attach a yellow ring terminal connector.

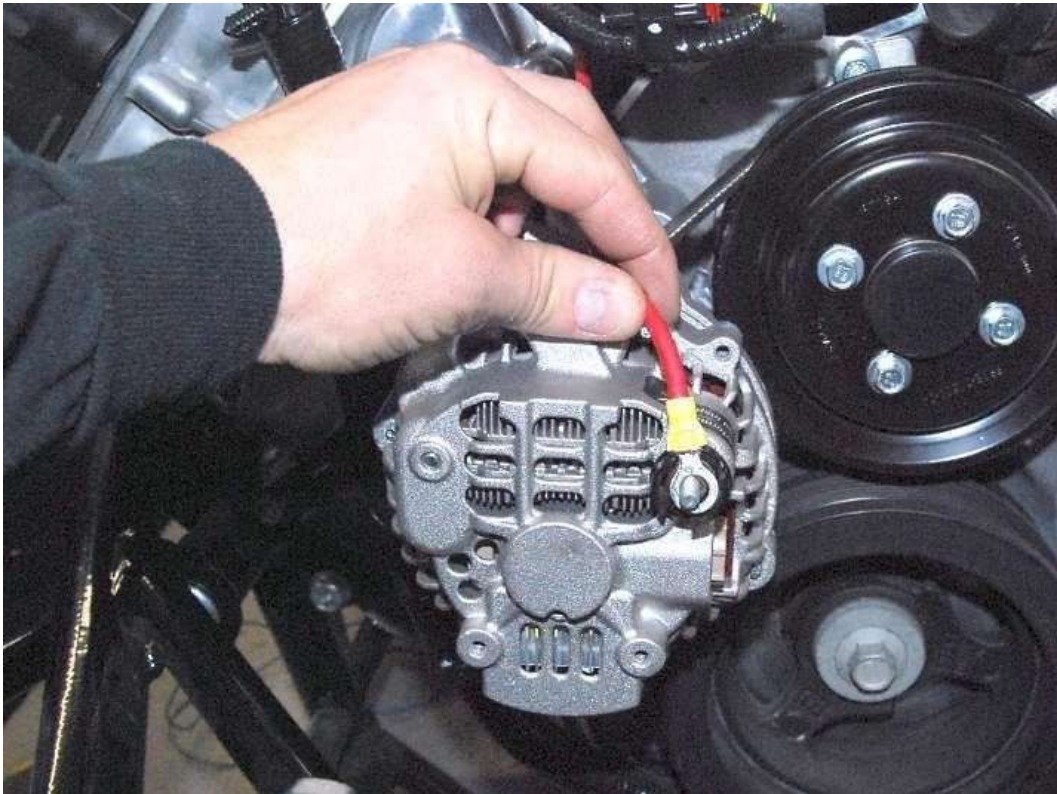

Put the ring terminal on the alternator output post.



Tighten the locknut on the output post so that the nut is snug. Do not over-tighten or the post might break.

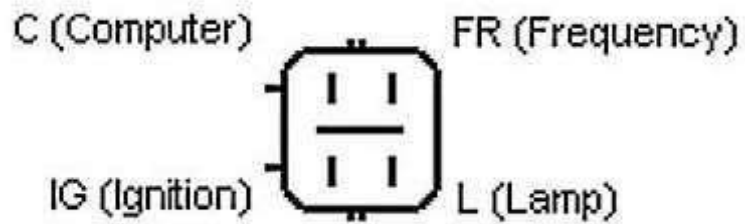

Looking at the alternator.

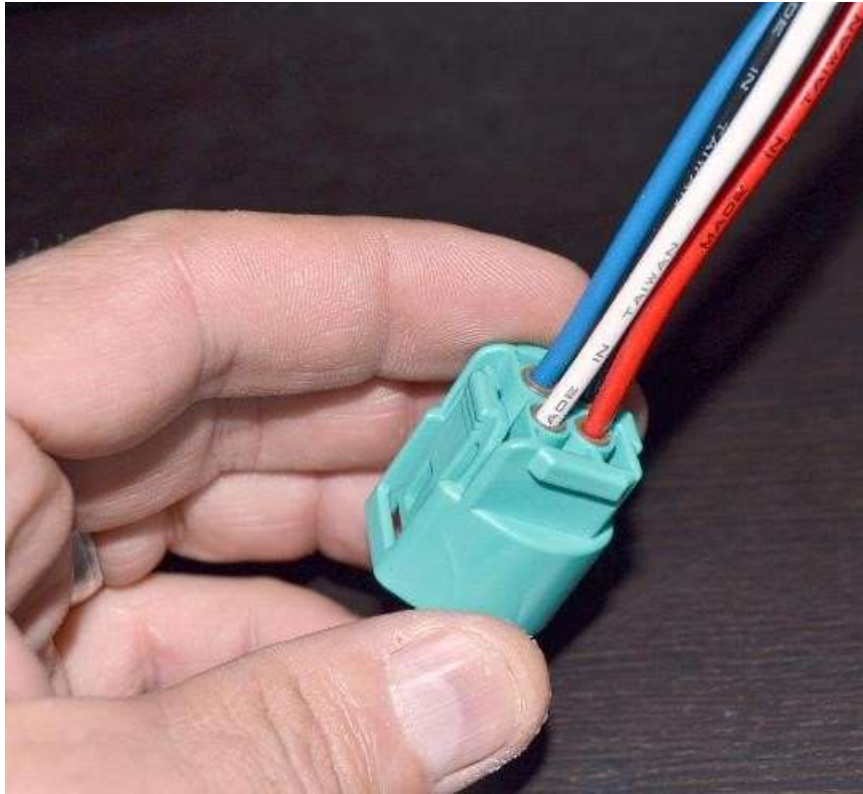

If a dash charge indicator light is desired, run a wire from the red “Lamp” wire on the connector back to a dash light that is grounded on the other side of the light.

Locate the chassis harness brown alternator wire connect it to the Alternator plug white “Ignition” wire.



Connect the plug to the Alternator.

Radiator Cooling Fan

- ✎ It is best to let the engine control the radiator fan. If you do not want to do this, do not use the wires and remove the correct radiator fan fuse from the black box.

There are two ways to run the orange Coyote harness fan wire, either to the front chassis or up into the cockpit and to the fuse panel, whatever is more convenient. If necessary, use the 14ga blue wire in the coyote install kit to reach.

- ✎ Do not cut the chassis harness blue wire if you are also running A/C.

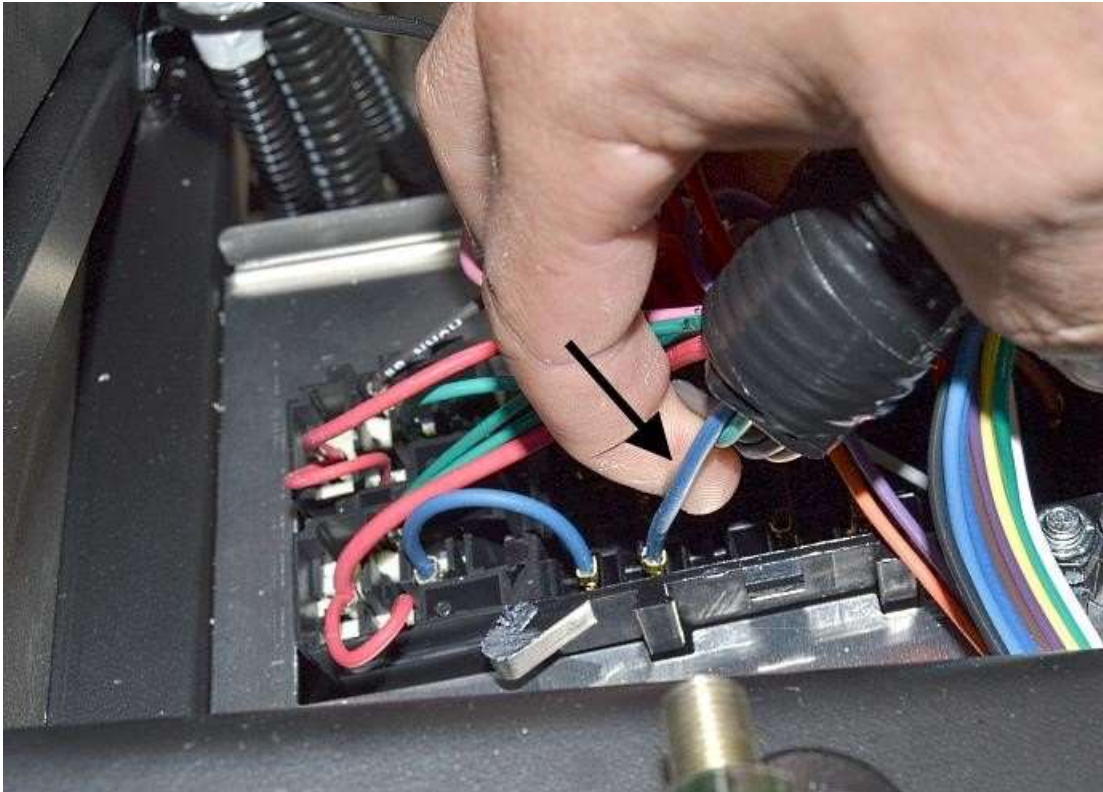

If running to the fuse panel, remove the insulation on the blue fan wire going into the harness and solder the coyote fan wire to it or butt connect making sure to reconnect the chassis harness blue fan wire as well.

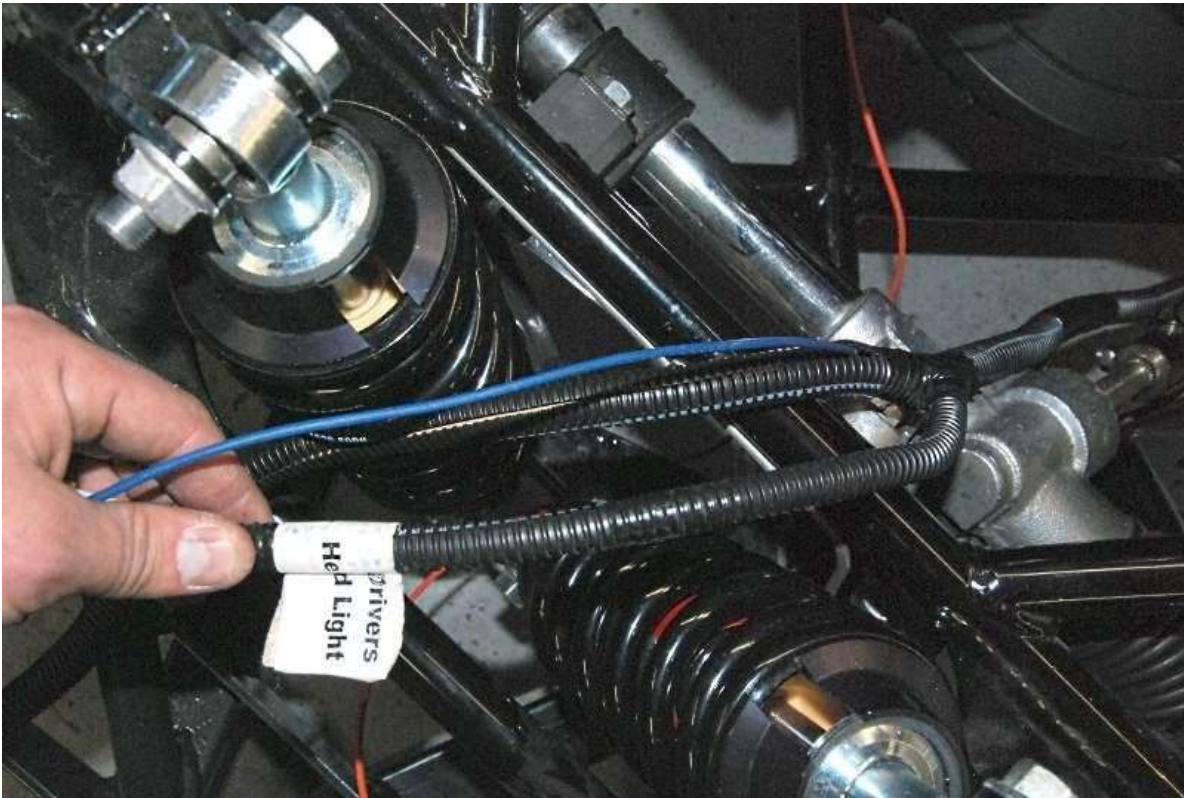

If running to the front chassis harness, pull the blue fan wire out of the harness and remove the insulation on the blue fan wire going into the harness. Solder the coyote fan wire to it or butt connect making sure to reconnect the chassis harness blue fan wire as well.

Battery power



Mount the inline fuse near the fuse panel using $\frac{3}{16}$ " rivets then run the short battery cable from one side of the inline fuse to the fuse panel stud.

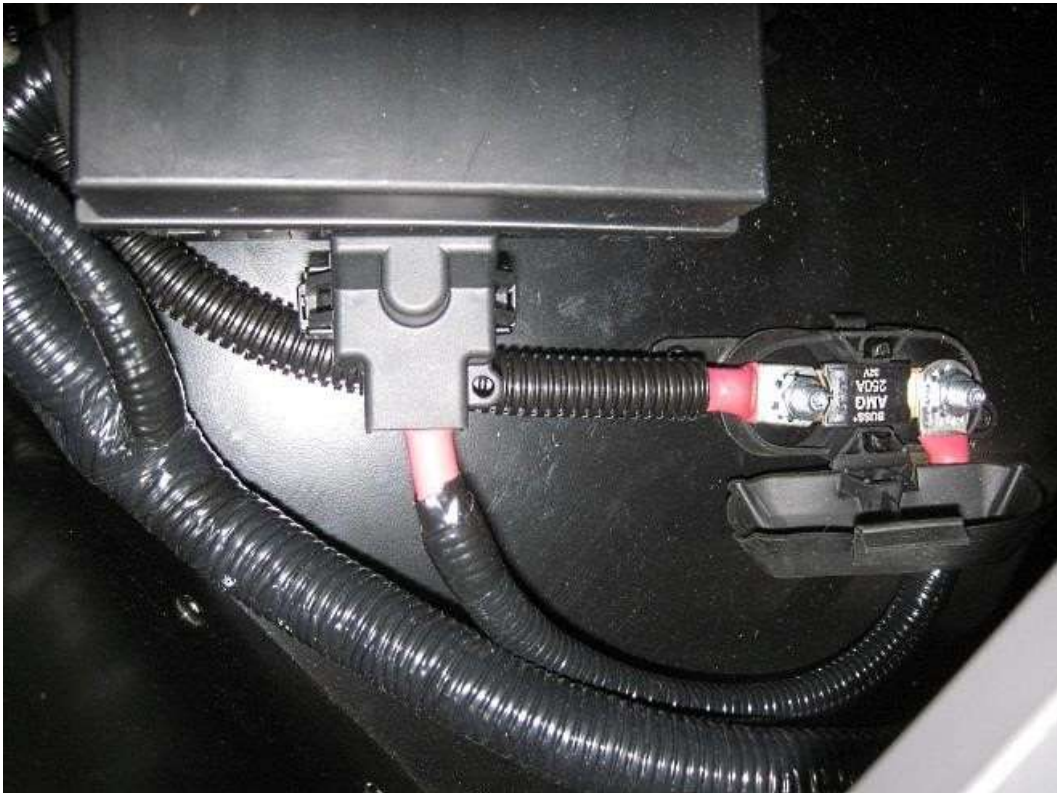

From the other inline fuse stud run a battery cable to the starter battery cable or to a battery cut-off switch.

Fuel Pump

Route the Coyote harness fuel pump green wire to the back of the chassis harness fuse panel.

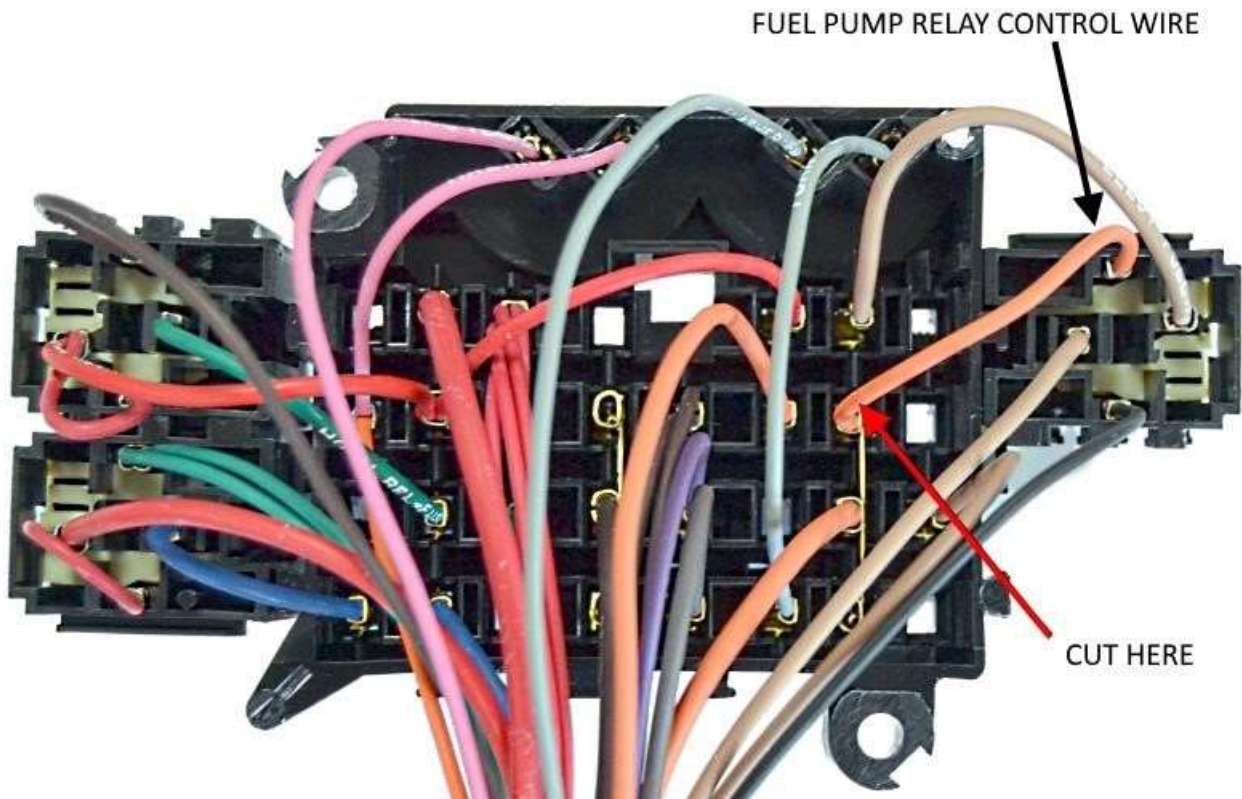

On the chassis harness, cut the small ORANGE jumper wire close to the buss bar that it jumpers from and connect the fuel pump wire from the EFI harness to the orange relay wire. This will use the EFI computer to turn the relay on/off.

The Inertia switch grounds the relay so this wiring still uses the inertia switch.

Use a Blue Butt connector or Solder and tape the green wire and Fuel pump relay wires together. Make sure the wires and harness are out of the way of the steering shaft.

OBD 2 Port



Locate the OBD 2 port on the 2"x 2" tube to the right of the steering wheel.



Use some of the aluminum panel #6 screws to attach the OBD 2 plug to the frame.

Start power

✂ Soldering iron, wire cutters/strippers, electrical tape



Attach a ring connector to the black ground wire and ground it to the chassis.



Locate the EFI/crank and coil wires in the chassis harness.

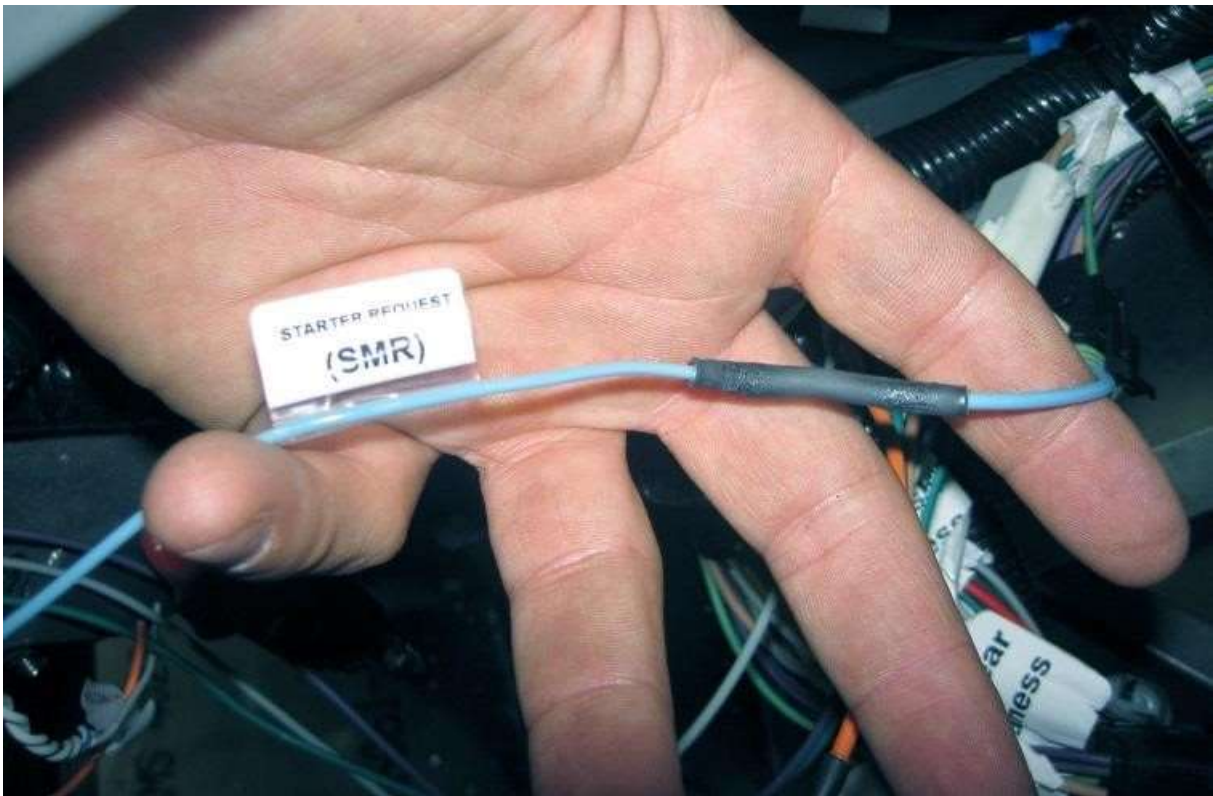

Attach the blue starter wire to the blue EFI wire in the harness using a red butt connector.

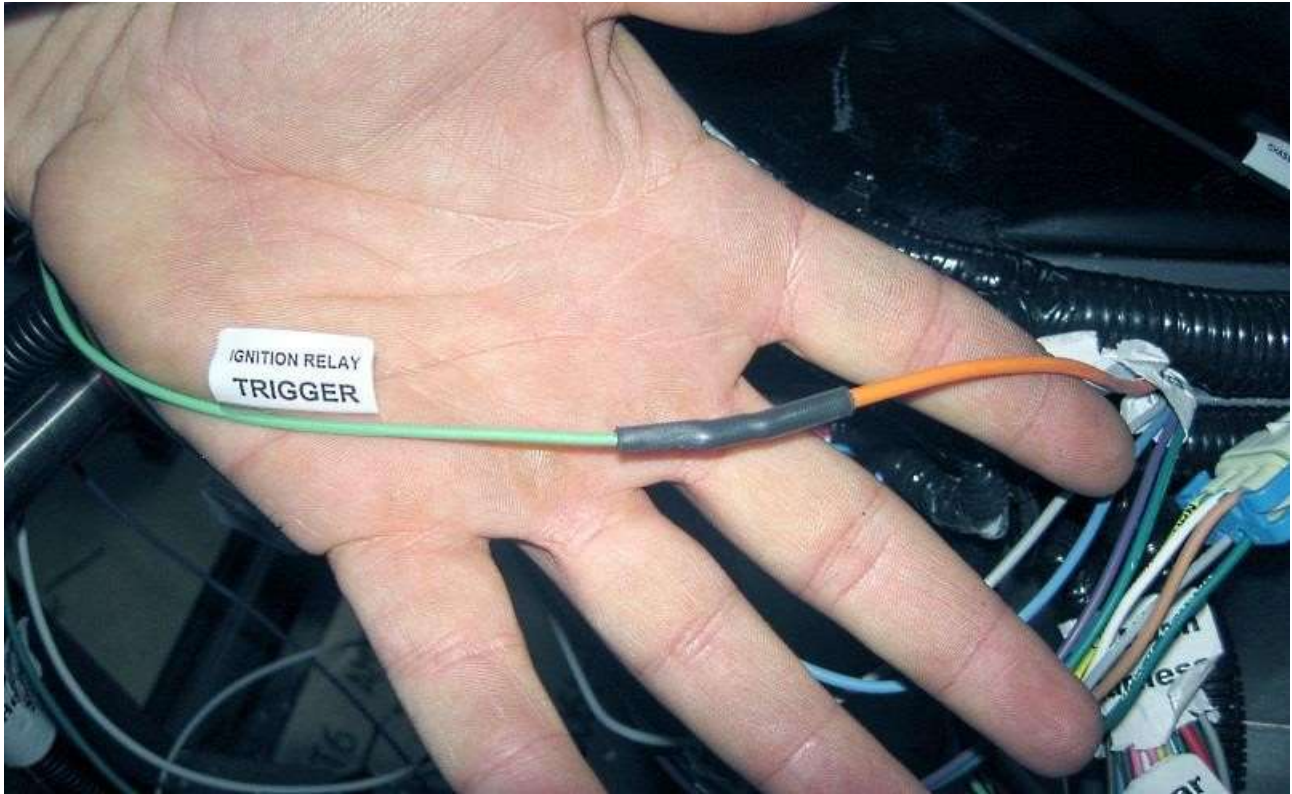

Attach the light green ignition trigger wire to the orange EFI wire in the harness using a red butt connector.

☞ We use the PCM engine starting directions in the Ford Performance instructions. This uses the engine harness starting wire to engage the starter.



Find the clutch safety switch wires in the left footbox.

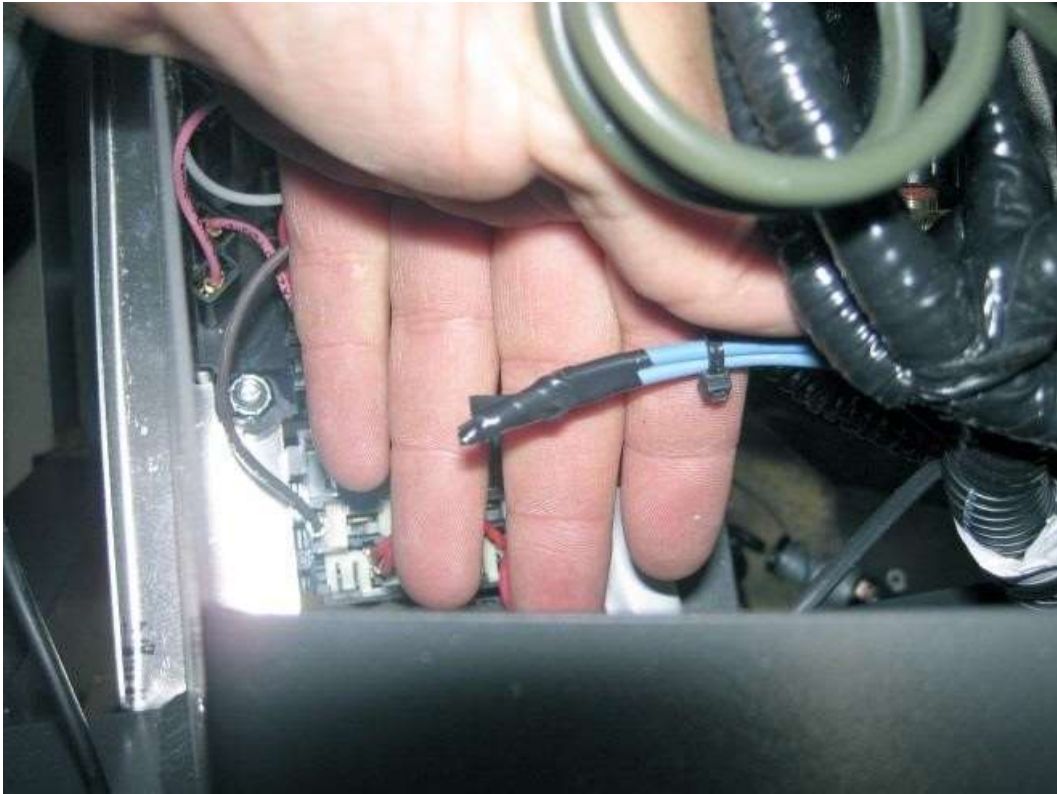

If a neutral safety switch is not going to be used, cut one of the two blue chassis harness wires slightly shorter than the other so the ends do not touch and electrical tape the end.



In the chassis harness on the starter wires leg, cut the blue starter wire end off.



Pull the loom back further down the leg then pull the blue wire out so it does not stick out for the harness and cut it off.



Electrical tape the end to the other wires.

Tach

✂ Soldering iron, wire cutters/strippers, electrical tape.

- ✎ There is no tach wire in the engine harness. The tach will need to get connected to a coil wire.
- ✎ The Tach wiring depends on the gauges being used. If using the Autometer Platinum gauges, they will require a Tach Adapter, FFR# 25284

Autometer gauges

- ✎ The Tach adapter must be hooked up to the main wire feeding all of the coils, not an individual coil

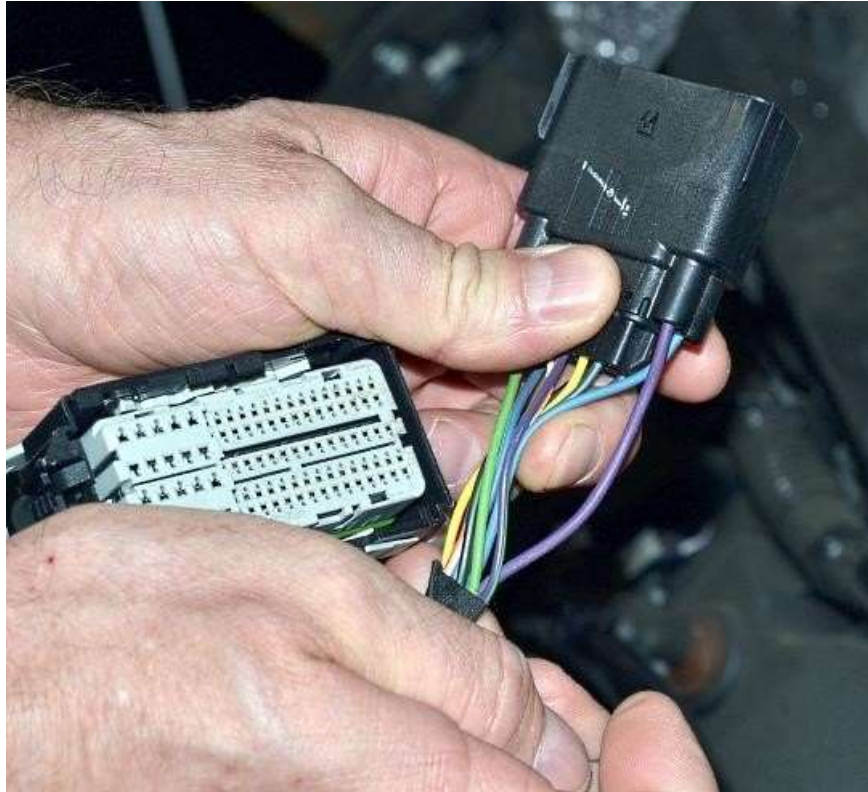

Splice the tach adapter red/green wire to the purple wire in the engine control harness small plug that is on the engine.

Connect the tach adapter red wire to +12v, black wire to ground, and gray wire to the tach.

FFR vintage gauges

- ✎ The tach will need to get connected to a coil wire as shown in the gauge instructions according to the Type #3 Coil on plug description.



Run the sending unit harness along the left top side of the engine.



At the #4 cylinder, pull the chassis harness tach wire (purple) out of the harness and remove the tape covering the coil plug wires.



Use a razor knife and wire strippers to remove a short section of the wire insulation on the **blue/red** wire.



Solder the tach wire to the blue/red wire.



Wrap the connection in electrical tape.



Re-wrap the coil plug wires.

Oil Pressure and Water temp sensors



Continue the sending unit harness to the front of the engine.



Use some of the kit 3/4" loom to cover a couple of the smaller looms to declutter the wiring.

Run the wires down the front of the engine to the sending units.



Attach the gauge sensor wires to the correct sensor.

Clutch cable



Attach the clutch cable to the quadrant and to the clutch fork.

Exhaust

- ✂ 15mm, 17mm sockets, 15mm wrench
- 🚗 Coyote headers, straight pipes
- 👤 Insert and tighten all of the bolts by hand before tightening any with a wrench.

Attach the headers to the engine.

O₂ Harness

- ✂ 18mm wrench.
- 🚗 Transmission harness, O₂ sensors
- 👤 The left and right side O₂ sensor wires are different lengths, the long one is for the right side.



Locate the transmission harness bag in the control pack box.

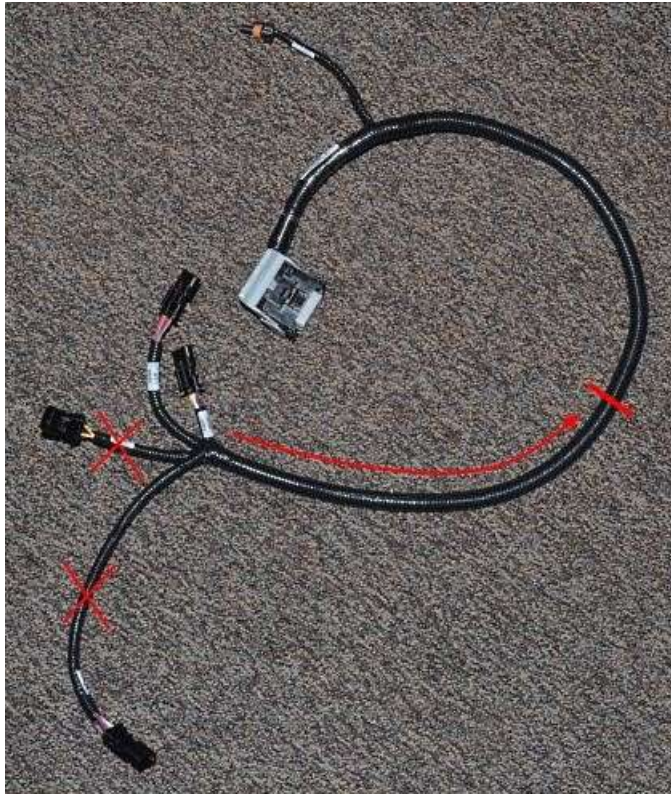

The harness needs to be unwrapped from the end with the four plugs to half way up the length to the computer plug in order to reach both O₂ sensor locations.

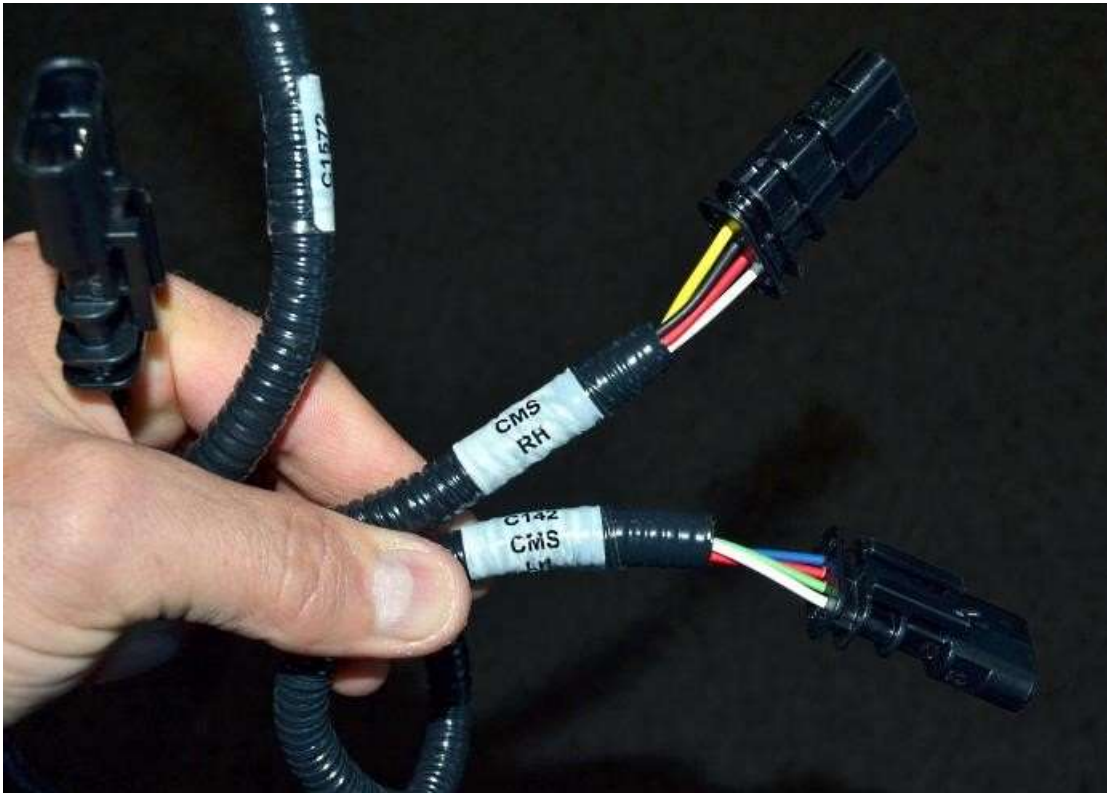

The two CMS 4-wire plugs are not used so the wires can be cut back to where the harness is unwrapped.

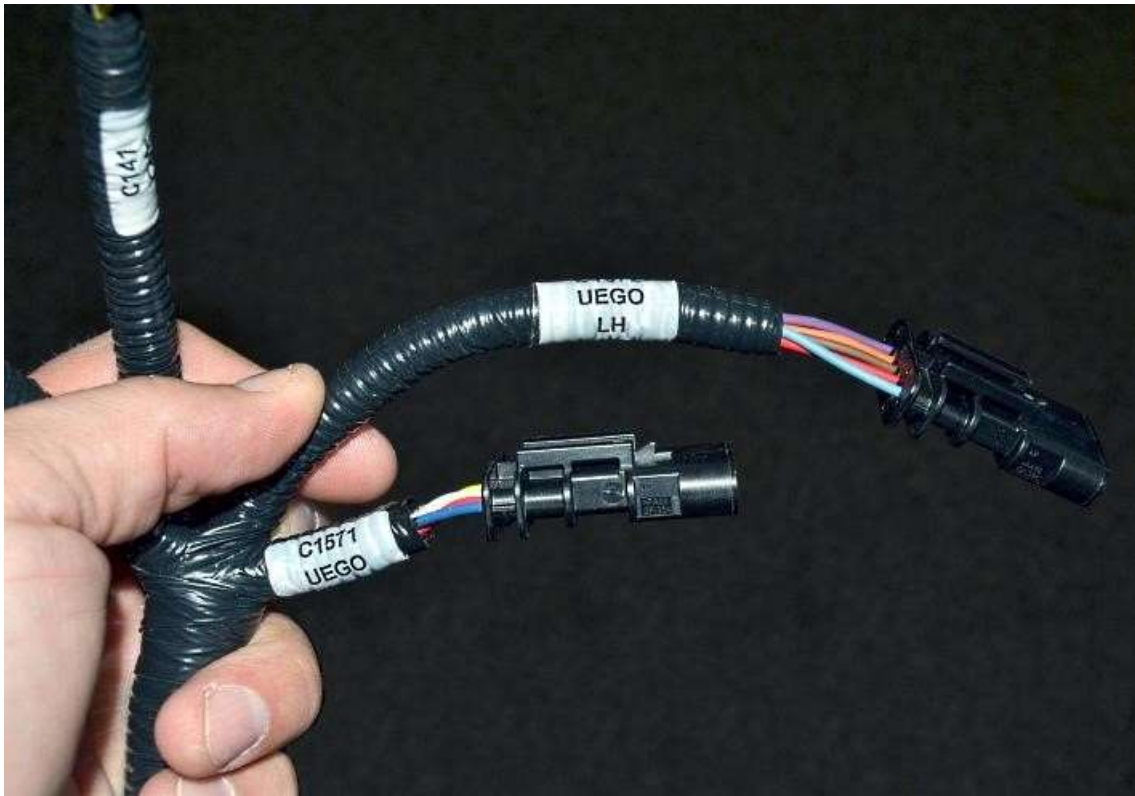

The UEGO 5-wire plugs are the O₂ sensor plugs. Separate these wires out and use some of the kit ½” wire loom to cover the wires up.



Connect the “Transmission” harness plug to the computer.



Connect the single wire connector on the transmission harness to the plug on the engine main harness.



Locate the O₂ sensors in the control pack box.

Screw the O₂ sensors into the exhaust.

Run the left O₂ sensor wires either under or around the engine to the O₂ sensor. Connect the right O₂ sensor wires to the sensor.

Starting the engine

🚗 Oil, Coolant

If not already done, fill the engine with 8 quarts of the correct oil.



If not already done, fill the engine with coolant through an inline filler or radiator cap. To help remove air from the system, remove the top cap until coolant starts going up the tube then recap and hose clamp.

Fill the coolant overflow container.

Set the Fuel pressure regulator to the correct pressure as described in the Ford Performance engine control instructions.

Start the engine and allow the engine to get up to 195°F- 200°F then allow to cool completely, it will suck coolant from the overflow.

👉 Cooling fan is switched on at 195°F, turns off at 190°F. This is based on inferred engine coolant temperature. Engine coolant temperature is inferred from the cylinder head temperature. Inferred coolant temperature may not be the same as actual coolant temperature.

Once cool, check the radiator/inline filler neck and coolant overflow container. Top up with coolant if necessary.

👉 The ECU has a base tune, it is strongly recommended to have the car dyno tuned after completion.